

**DEVELOPMENT OF PREDICTIVE MODELS FOR SYNERGISTIC IMPACT OF  
AGE, PERIOD OF EXPOSURE AND NOISE LEVEL IN QUARRIES ON  
HEARING THRESHOLD OF WORKERS**

**BY**

**Kolawole Taofik ORIOLOWO**

**MATRIC NO.: 72691**

**B.Sc., M.Sc. Industrial and Production Engineering (Ibadan)**

**A Thesis in the Department of Industrial and Production Engineering,  
Submitted to the Faculty of Technology  
in partial fulfilment of the requirements for the Degree of**

**DOCTOR OF PHILOSOPHY**

**of the**

**UNIVERSITY OF IBADAN**

**JULY 2023**

## **CERTIFICATION**

I certify that this work was carried out by Engr. Kolawole Taofik ORIOLOWO in the Department of Industrial and Production Engineering, University of Ibadan.

-----  
Supervisor

O.G. Akanbi

BSISE (Ohio state), M.Sc., MBA (Oklahoma State), Ph.D. (Ibadan).

MNSE, MNIEM, MNIIE, (COREN Regd.),

SAP Certified, IASSC – Green Belt,

IASSC – Black Belt.

Professor, Department of Industrial and Production Engineering,  
University of Ibadan, Nigeria

## **DEDICATION**

This work is dedicated to GOD and the entire members of Dosumu - Opeifa family.

## ACKNOWLEDGEMENTS

I am grateful to the lord who has been the source of strength and success in all my endeavours. More so, giving me another opportunity to tap from his unquantifiable resources to better humanity and to further update my knowledge. I am and will forever remain indebted and grateful to my supervisor, Prof. O. G. Akanbi for his in-depth constructive criticisms, financial, material resources and the time he made available for the success of this work. I must express my gratitude to his wife, Dr. (Mrs.) T. Akanbi for her hospitality, words of encouragement and also creating the enabling environment for her husband to actually do a thorough supervision of this work.

I am also indebted to the Head of Department, Engr. Dr. Mrs. Mojisola Bolarinwa, and other lecturers in the Department of Industrial and Production Engineering of the University of Ibadan, The Sub Dean, Post Graduate School, and The Dean, Faculty of Technology.

I would like to thank my mentors, Engr. Prof. S. O. Ismaila and Engr. Dr. K. A. Oladejo, both of you have been instructive without reservations over the years and also for their moral support enshrined in love for the completion of this work. Many thanks go to my amiable friend, Mr. Akanbi Abubakar for his unalloyed support and patience for the success of this research when the voyage was tough.

The efforts of Prof. A.E. Oluleye, Prof. Dare, Prof. Olapade, Dr. Edem, Dr. Odedairo, Dr. Abu Rahman, Dr. Bukola Afolabi, Mr. Idris Arowona, Mr. Osho Afolabi Zaccheus, Dr. Oseni, Engr. Busari, Deacon Olumide Adebayo, Pastor Kola Oyeniran and Evangelist Adolphus Olukunle are highly appreciated for their love and passion showered on me in order to achieve this goal.

My profound gratitude to the entire members of Dosumu - Opeifa family for their financial contribution through their inspirational characteristics challenging me and setting a standard for me which I followed and made me to succeed in my struggle to achieve tertiary academic education in my life.

My salutation goes to Peace, Bright, Goodluck and Khadijat with their mum for their tremendous support to the success of this work. I will not fail to appreciate the humanity and friendly support enjoyed from Olajumoke Ayomikun Ayansola during the struggle period, I prayed that God will reward her abundantly. My acknowledgment to Alhaji M.A. Oladele for his dedicated administrative skill at the inception of this PhD programme.

My profound appreciation goes to the management and staff of the quarries that made it possible for the conduct of this research.

Finally, how joyous I would be if Engr. E.M. Owoeye is alive today, ditto Evangelist Samuel Jemibewon and Pastor Olowu, may God grant the trio eternal rest in paradise (Amen). My sister-in-law, Late Mrs. Asiat Adeola Ajimobi (Nee Azeez); and Late Shakiru Omoniyi both of you are my good companions. I pray Almighty Allah grant both of you Aljannah Fridaos.

## ABSTRACT

Despite the importance of quarry operations to the construction industry in developing countries, the excessive occupational noise involved in quarry operations is a threat to the health of workers. Studies have shown that the age and years of work exposure (YE) are two of the major factors that contribute to auditory health problems among the quarry workers. Information on the effect of noise and related susceptibility factors on hearing damage among Nigerian quarry workers are sparse. This study was conducted to develop suitable models in order to investigate the synergistic influence of age, YE and Noise Level (NL) in quarries on the Hearing Threshold (HT) of workers.

Questionnaires were administered to 204 quarry workers, who were randomly selected in the year 2018 from four different quarry sites in southwestern Nigeria, to obtain the age and YE. A follow up study was conducted on 185 of them in 2019. The NL at the quarry sites during the working hours were measured using a digital sound level meter, while an audiogram measured the HT at eight different frequencies (0.25, 0.50, 1.00, 2.00, 3.00, 4.00, 6.00 and 8.00kHz). Using ANOVA, eight regression models were developed and validated to predict both the effects of age, YE and NL on HT, and the safe HT. These were used to test for both the similarity of the NL conditions in the sites and the predictive significance of the regression model terms. The predictive accuracies of the developed models were evaluated using the predicted  $R^2$ , while paired sample t-test and correlation statistics were used to ascertain the impact of the workers' continual exposure to noise within the study period. Analyses were done using t-test at  $\alpha_{0.05}$ .

The percentage distribution of their age range in years were 9.7% (15-30), 50.8% (31-45), 38.4% (46-60), and 1.1% (60+). The mean age and YE were  $42 \pm 9.01$  and  $18 \pm 7.03$  years, respectively. The NL were in the range of 87.30-116.98dB as against the permissible exposure level of 85.00dB. The NL conditions on the sites were not significantly different ( $101.61 \pm 0.38$ ,  $99.28 \pm 0.51$ ,  $100.51 \pm 1.01$ ,  $99.28 \pm 0.10$ ). The Mean HT of the workers was  $45.60 \pm 1.24$ dB and 75.0% of them had HT higher than the safe HT of  $\leq 30.00$ dB. The age predicted the workers' HT at all frequencies considered. The YE significantly predicted the HT at 1.00, 2.00, and 4.00 kHz, while NL significantly predicted the HT at 0.25 and 0.50 kHz. The models' predicted  $R^2$  range was 0.71 – 0.82. The safe HT was predicted with age  $\leq 52$  years and YE  $\leq 32$  years. The validation results were in agreement with the data obtained during the experiment. The correlation and paired sample ranges were 0.17-0.79 and 6.50-26.7, respectively, which showed that the workers' HT continuously depreciated within the study period.

The developed models established that the synergistic factors of age, years of exposure and noise level influenced the hearing threshold of quarry workers. Thus, the models can be used for making decision in achieving workers' safe operations in quarry industry.

**Keywords:** Quarry industry, Occupational noise, Noise level, Hearing threshold.

**Word count:** 489

## TABLE OF CONTENTS

| <b>Contents</b>   | <b>Pages</b> |
|---|--------------|
| Title Page  | i            |
| Certification   | ii           |
| Dedication  | iii          |
| Acknowledgements  | iv           |
| Abstract  | v            |
| Table of Contents   | vi           |
| List of Tables  | ix           |
| List of Plates  | x            |
| List of Figures   | xi           |
| List of Abbreviations   | xiii         |
| <br>  |              |
| <b>CHAPTER ONE</b>  | <b>1</b>     |
| <b>INTRODUCTION</b>   | <b>1</b>     |
| 1.1 Background of the study   | 1            |
| 1.2 Statement of the Problem  | 3            |
| 1.3 Aim and Objectives of the Study   | 4            |
| 1.4 Justification for the Research  | 4            |
| 1.5 Scope and Limitation of the Study   | 5            |
| 1.6 Outline of Succeeding Chapters  | 5            |
| <br>  |              |
| <b>CHAPTER TWO</b>  | <b>6</b>     |
| <b>LITERATURE REVIEW</b>  | <b>6</b>     |
| 2.1 The problem of Noise  | 6            |
| 2.2 Hearing Loss  | 6            |
| 2.3 Effects of Noise on Human Health  | 9            |
| 2.4 Controlling Noise Exposure  | 9            |
| 2.5 Studies on Age related Noise Effects  | 11           |
| 2.6 Predictive Models for Design Purpose  | 11           |
| 2.7 Multiple Linear Regressions   | 11           |
| 2.8 Neural Network Technique  | 12           |
| 2.9 Adaptive Neuro-Fuzzy Inference System (ANFIS)                                     | 12           |
| 2.10 Introduction to the Exhaustive Search and ANFIS Modelling                        | 13           |
| 2.11 Some Application of Adaptive Neuro - Fuzzy Inference System                      | 14           |
| 2.12 Response Surface Method Experimental Design                                      | 17           |
| 2.13 Analysis of a First-Order Response Surface                                       | 17           |
| 2.14 Historical Data Design for the Response Surface                                  | 20           |
| 2.15 Multiple Responses: The Desirability Approach                                    | 20           |
| 2.16 Previous Noise Related Research done on Using Artificial Intelligence<br>Methods | 22           |
| 2.17 Research Gap   | 25           |

|  |    |
|--|----|
| <b>CHAPTER THREE</b>   | 26 |
| <b>METHODOLOGY</b>   | 26 |
| 3.1 Criteria for the Measurement of Sound  | 26 |
| 3.1.1 Subject selection  | 27 |
| 3.1.2 Assessing noise levels   | 28 |
| 3.1.2.1 Procedure followed in measuring noise exposure with sound level<br>Meter   | 28 |
| 3.1.2.2 Noise exposure assessment  | 29 |
| 3.1.2.3 Measurement of pure tone audiogram / hearing status<br>(Audiometric test)  | 32 |
| 3.2 Test of Variance between the 2018 and 2019 Dataset   | 32 |
| 3.3 Exhaustive Search and ANFIS Modelling on the Data  | 34 |
| 3.4 Presentation and Analysis of the Models  | 34 |
| 3.4.1 ANFIS training models for hearing threshold at different frequency<br>levels   | 35 |
| 3.4.2 Model development  | 37 |
| 3.4.3 Selections of regression model inputs  | 38 |
| 3.4.3.1 Regression modelling   | 39 |
| 3.4.3.2 Model assumption   | 39 |
| 3.4.4 Statistical analysis   |    |
| 3.4.4.1 Response surface method  | 40 |
| 3.5 Selection of Values of Age, Years of Exposure and Noise Level for the<br>Safe Hearing Threshold  | 41 |
| 3.5.1 Determination of the combination of values of age, years of exposure<br>and noise level that can result to the safe hearing threshold of workers | 42 |
| 3.6 Effects of age, years of exposure and noise level on hearing threshold<br>over time  | 42 |
| 3.7 Ergonomic Evaluation of Hearing Threshold Predictors   | 42 |
| <b>CHAPTER FOUR</b>  | 44 |
| <b>RESULTS AND DISCUSSION</b>  | 44 |
| 4.0 Chapter Overview   | 44 |
| 4.1 Hearing Threshold of the respondents within the Four Quarries  | 47 |
| 4.2 General Noise levels and Hearing Threshold within Quarries   | 47 |
| 4.2.1 Noise Measurement at Various Facilities under Study  | 47 |
| 4.2.2 Hearing Threshold of respondents within the Quarries.  | 50 |
| 4.3 ANFIS exhaustive search results for the factors that affect workers’<br>hearing threshold at the various frequencies considered                    | 50 |
| 4.4 ANFIS Models Hearing Threshold Accuracies at Various Frequencies   | 60 |
| 4.5 ANOVA for Quadratic Models Hearing Threshold outcomes at<br>Various Frequencies  | 91 |
| 4.5.1 Hearing Threshold at 250 Hz  | 91 |
| 4.5.2 Hearing Threshold at 500 Hz  | 91 |
| 4.5.3 Hearing Threshold at 1 kHz   | 95 |
| 4.5.4 Hearing Threshold at 2 kHz   | 95 |
| 4.5.5 Hearing Threshold at 3 kHz   | 98 |
| 4.5.6 Hearing threshold at 4 kHz   | 98 |

|        |   |     |
|--------|---|-----|
| 4.5.7  | Hearing threshold at 6 kHz  | 101 |
| 4.5.8  | Hearing threshold at 8 kHz  | 101 |
| 4.6    | Model Equation in Terms of Actual Factors at Frequency 250 Hz, 500 Hz, 1 kHz, 2 kHz, 3 kHz, 4 kHz, 6 kHz and 8 kHz          | 104 |
| 4.7    | Normal Probability Plot of Residuals and Predicted Output for Hearing Threshold at Different Frequencies                    | 105 |
| 4.8    | Effect of Single Factors on the Hearing Threshold at Various Frequencies  | 114 |
| 4.9    | Comparative statistics for hearing threshold of real and control experiments  | 120 |
| 4.10   | Robustness of the models  | 126 |
| 4.10.1 | Adequacy of the models  | 126 |
| 4.10.2 | External validation of the models   | 126 |
| 4.10.3 | Predictive performance of the models  | 127 |
| 4.11   | Selection of values of age, years of exposure and noise level for the safe hearing threshold                                | 128 |
| 4.12   | Age, Years of Exposure and Noise Level that can Accommodate Safe Hearing Threshold  | 139 |
| 4.13   | Effects of Age, Years of Exposure and Noise level on Hearing Threshold over Time  | 141 |
| 4.13.1 | Paired Sample Pearson Correlation Coefficient of Mean Difference between Hearing Threshold at different Frequencies         | 141 |
| 4.13.2 | Paired Sample Statistics of the First and Second Year of Mean Hearing Threshold of the Respondents at different Frequencies | 141 |
| 4.13.3 | Paired Sample t test for Differences in the Hearing Threshold in the First and Second year                                  | 144 |
| 4.14   | Results of Ergonomic Evaluation of Hearing Threshold Predictors   | 144 |
| 4.15   | Discussion of Results   | 147 |
| 4.15.1 | Noise Magnitude of the Machinery used in Quarry Operation   | 147 |
| 4.15.2 | Predictive Models   | 147 |
| 4.15.3 | Combination of values of age, years of exposure and noise level that produce safe hearing threshold                         | 148 |
| 4.15.4 | Effects of Age, Years of Exposure and Noise Level with Hearing Threshold over Time at Different Frequencies                 | 149 |
|        | <b>CHAPTER FIVE</b>   | 150 |
|        | <b>SUMMARY, CONCLUSION AND RECOMMENDATIONS</b>  | 150 |
| 5.1    | Summary   | 150 |
| 5.2    | Conclusion  | 150 |
| 5.3.   | Recommendations   | 151 |
| 5.4    | Contributions to Knowledge  | 151 |
|        | <b>REFERENCES</b>   | 153 |
|        | <b>APPENDICES</b>   | 165 |



## LIST OF TABLES

| <b>Table</b> | <b>Title</b>  | <b>Page</b> |
|--------------|---|-------------|
| 2.1:         | World Health Organisation classification of hearing impairment  | 8           |
| 2.2:         | Selection of Hearing Protection Devices according to CSA  | 10          |
| 4.1:         | Distribution of Demographic Characteristics of Respondents in the Year 2018   | 45          |
| 4.2:         | Distribution of Demographic Characteristics of Respondents in the Year 2019   | 46          |
| 4.3:         | Average noise levels (dBA) measured in workstations in the four quarries in 2018  | 48          |
| 4.4:         | Average Noise Levels (dBA) Measured in Workstations in the Four Quarries in 2019  | 49          |
| 4.5:         | RMSE and R- values for hearing threshold at 500Hz   | 61          |
| 4.6:         | RMSE and R-values for hearing threshold at 1kHz   | 65          |
| 4.7:         | RMSE and R-values for hearing threshold at 2kHz   | 70          |
| 4.8:         | RMSE and R-values for hearing threshold at 3kHz   | 74          |
| 4.9:         | RMSE and R-values for hearing threshold at 4kHz   | 78          |
| 4.10:        | RMSE and R-values for the hearing threshold at 6kHz   | 83          |
| 4.11:        | RMSE and R-values for hearing threshold at 8kHz   | 87          |
| 4.12:        | ANOVA for quadratic model for the hearing threshold at 250Hz  | 93          |
| 4.13:        | ANOVA for quadratic model for the hearing threshold at 500Hz  | 94          |
| 4.14:        | ANOVA for quadratic model for the hearing threshold at 1kHz   | 96          |
| 4.15:        | ANOVA for quadratic model for the hearing threshold at 2kHz   | 97          |
| 4.16:        | ANOVA for quadratic model for the hearing threshold at 3kHz   | 99          |
| 4.17:        | ANOVA for quadratic model for the hearing threshold at 4kHz   | 100         |
| 4.18:        | ANOVA for quadratic response model for the hearing threshold at 6kHz  | 102         |
| 4.19:        | ANOVA for quadratic model for the hearing threshold at 8kHz   | 103         |
| 4.20:        | Summary of ANOVA for quadratic models and statistics for hearing threshold of real and control experiments  | 127         |
| 4.21:        | : Summary of the statistics of the models across the frequency  | 129         |
| 4.22:        | Optimization Response Output - Hearing Threshold at 250 to 8 kHz  | 130         |
| 4.23:        | Summary of the values of age, years of exposure and noise level at 250-8kHz for safe hearing threshold values of 25-30dB  | 140         |
| 4.24:        | Paired sample Pearson correlation coefficient of mean differences between hearing threshold in the first year and second year of measurement at various frequencies | 142         |
| 4.25:        | Paired sample statistics of mean hearing threshold of the respondents in the first and second year at various frequencies   | 143         |
| 4.26:        | Paired sample t - test for differences in the hearing threshold in the first and second year  | 145         |

## LIST OF PLATES

| <b>Plate</b> | <b>Title</b>      | <b>Page</b> |
|--------------|-------------------|-------------|
| 3.1a:        | Sound level meter | 32          |
| 3.1b:        | Sound callibrator | 33          |

## LIST OF FIGURES

| <b>Figure</b> | <b>Title</b>  | <b>Page</b> |
|---------------|---|-------------|
| 2.1:          | Structure of Adaptive Neuro-Fuzzy inference system network with two Inputs and an output            | 16          |
| 3.1:          | ANFIS Architecture for input and output factors   | 36          |
| 4.1:          | Exhaustive search for the operating parameters on hearing threshold at 250Hz                        | 51          |
| 4.2:          | Exhaustive search for the operating parameters on hearing threshold at 500Hz                        | 52          |
| 4.3:          | Exhaustive search for the operating parameters on hearing threshold at 1kHz                         | 53          |
| 4.4:          | Exhaustive search for the operating parameters on hearing threshold at 2kHz                         | 55          |
| 4.5:          | Exhaustive search for the operating parameters on hearing threshold at 3kHz.                        | 56          |
| 4.6:          | Exhaustive search for the operating parameters on hearing threshold at 4kHz                         | 57          |
| 4.7:          | Exhaustive search for the operating parameters on hearing threshold at 6kHz                         | 58          |
| 4.8:          | Exhaustive search for the operating parameters on hearing threshold at 8kHz                         | 59          |
| 4.9:          | Plot of original data against predicted data for model estimation of the hearing threshold at 500Hz | 62          |
| 4.10:         | Plot of predicted output with residuals for the hearing threshold at 500Hz                          | 63          |
| 4.11:         | Regression plot of experimental and predicted output for the hearing threshold at 500Hz             | 64          |
| 4.12:         | Plot of original data against predicted data for model estimation of the hearing threshold at 1kHz  | 66          |
| 4.13:         | Plot of predicted output with residuals for the hearing threshold at 1kHz                           | 68          |
| 4.14:         | Regression plot of experimental and predicted output for the hearing threshold at 1kHz              | 69          |
| 4.15:         | Plot of original data against predicted data for model estimation of the hearing threshold at 2kHz  | 71          |
| 4.16:         | Plot of predicted output with residuals for the hearing threshold at 2kHz                           | 72          |
| 4.17:         | Regression plot of experimental and predicted output for the hearing threshold at 2kHz              | 73          |
| 4.18:         | Plot of original data against predicted data for model estimation of the hearing threshold at 3kHz  | 75          |
| 4.19:         | Plot of predicted output with residuals for the hearing threshold at 3kHz                           | 76          |
| 4.20:         | Regression plot of experimental and predicted output for the hearing threshold at 3kHz              | 77          |
| 4.21:         | Plot of original data against predicted data for model estimation of the hearing threshold at 4 kHz | 80          |
| 4.22:         | Plot of predicted output with residuals for the hearing threshold at 4kHz                           | 81          |
| 4.23:         | Regression plot of experimental and predicted output for the hearing threshold at 4kHz              | 82          |
| 4.24:         | Plot of original data against predicted data for model estimation of the hearing threshold at 6kHz  | 84          |
| 4.25:         | Plot of Predicted Output with Residuals for the Hearing Threshold at 6kHz                           | 85          |
| 4.26:         | Regression plot of experimental and predicted output for the hearing threshold at 6kHz              | 86          |
| 4.27:         | Plot of original data against predicted data for model estimation of the hearing threshold at 8 kHz | 88          |

|  |     |
|--|-----|
| 4.28: Plot of predicted output with residuals for the hearing threshold at 8kHz                    | 89  |
| 4.29: Regression plot of experimental and predicted output for the hearing threshold at 8kHz       | 90  |
| 4.30: Normal probability plot of residuals and predicted output for hearing threshold at 250Hz     | 106 |
| 4.31: Normal probability plot of residuals and predicted output for the hearing threshold at 500Hz | 107 |
| 4.32: Normal probability plot of residuals and predicted output for the hearing threshold at 1kHz  | 108 |
| 4.33: Normal probability plot of residuals and predicted output for the hearing threshold at 2kHz  | 109 |
| 4.34: Normal probability plot of residuals and predicted output for the hearing threshold at 3kHz  | 110 |
| 4.35: Normal probability plot of residuals and predicted output for the hearing threshold at 4kHz  | 111 |
| 4.36: Normal probability plot of residuals and predicted output for the hearing threshold at 6kHz  | 112 |
| 4.37: Normal probability plot of residuals and predicted output for the hearing threshold at 8kHz  | 113 |
| 4.38: Effect of one factor on the hearing threshold at 250Hz                                       | 115 |
| 4.39: Effect of one factor on the hearing threshold at 500Hz                                       | 116 |
| 4.40: Response surface plots of age and noise level on the hearing threshold at 500Hz              | 117 |
| 4.41: Effect of one factor on the hearing threshold at 1kHz  | 118 |
| 4.42: Effect of one factor on the hearing threshold at 2kHz  | 119 |
| 4.43: Effect of one factor on the hearing threshold at 3kHz  | 121 |
| 4.44: Effect of one factor on the hearing threshold at 4kHz  | 122 |
| 4.45: Response surface plots of age and noise level on the hearing threshold at 4kHz               | 123 |
| 4.46: Effect of one factor on the hearing threshold at 6kHz  | 124 |
| 4.47: Effect of one factor on the hearing threshold at 8kHz  | 125 |
| 4.48: Ramp of optimization result for hearing threshold at 250Hz                                   | 131 |
| 4.49: Ramp of optimisation result for hearing threshold at 500Hz                                   | 132 |
| 4.50: Ramp of optimisation result for hearing threshold at 1kHz                                    | 133 |
| 4.51: Ramp of optimisation result for hearing threshold at 2kHz                                    | 134 |
| 4.52: Ramp of optimisation result for hearing threshold at 3kHz                                    | 135 |
| 4.53: Ramp of optimisation result for hearing threshold at 4kHz                                    | 136 |
| 4.54: Ramp of Optimisation result for hearing threshold at 6kHz                                    | 137 |
| 4.55: Ramp of optimization result for hearing threshold at 8kHz                                    | 138 |

## LIST OF ABBREVIATIONS

### ACRONYMS

Adeq  
Adj  
AG  
ANFIS  
ANN  
ANSI  
CV  
FIS  
FL  
HDD  
HL  
HPD  
HT  
MFS  
MSE  
NIHL  
NL  
NN  
NRR  
Nummfs  
Ob  
PEL  
PRE  
Pred  
PTA  
PTS  
R<sup>2</sup>  
RMSE  
RSM  
TTS  
TWA  
YE

### MEANING

Adequate Precision  
Adjusted Values  
Age of workers  
Adaptive Neuro-Fuzzy Inference System  
Artificial Neural Networks  
American National Standard Institute.  
Coefficient of Variation  
Fuzzy Inference System  
Fuzzy logic  
Historical Data Design  
Hearing Level  
Hearing Protective Devices.  
Hearing Threshold  
Membership function  
Mean Square Error  
Noise Induced Hearing Loss  
Noise Level  
Neural Network  
Noise Reduction Rating  
Membership functions number  
Observed Value(s),  
Permissible Exposure Level  
Predicted Value(s)  
Predicted Values  
Pure Tone Audiogram  
Permanent Threshold Shift  
Coefficient of Determination  
Root Mean Square Error  
Response Surface Method  
Transient Threshold Shift  
Time Weighted Average  
Years of Exposure

## CHAPTER ONE

### INTRODUCTION

#### 1.1 Background of the study

Noise is defined as an unwanted, excessive sound which can be harmful to the health and wellbeing of the subjects exposed to it (Al-Maghrabi *et al.* 2013; Fink, 2019). It is considered hazard and thus a safety problem because of its potential to negatively affect the safety and health of those exposed to it. Several occupational environments including construction, manufacturing, mining, music, agriculture and sports have been identified as being susceptible to noise hazards (Acoustical Surfaces, 2013; Pulsar Instruments, 2015). Nanda (2012) stated that noise types such as intermittent noise, impact or impulsive noise, repetitive impact noise, continuous wide band noise, continuous narrow band noise are continual occurrences in these types of occupational environments.

Research has shown that the chronic exposure to these noise forms could directly lead to irreparable physical health effects such as hearing damage (Le *et al.* 2017; Holman *et al.* 2019), rising cases of dementia (Lin *et al.* 2011), and increased rate of hospitalisation (Correia *et al.* 2013; He *et al.* 2019). In addition, other safety problems that have been indirectly linked with unwanted noise include physiological, psychological and psychosocial (Mick *et al.* 2014; Kamil and Lin, 2015; Cunningham and Tucci, 2017; Shukla *et al.* 2020) and economic consequences (Allen and Eddins, 2010; Bainbridge and Wallhagen, 2014). Thus to be able to significantly reduce or mitigate these noise related safety problems, there is need for the application of proper noise control measures.

The quarry industry is one that is also characterized by the predominance of noise pollution. It typically involves the use of high noise generating mechanical equipment for the extraction of materials from the surface of the earth to produce materials such as sand, stones, laterite clay and granite (Johnson, 2023). Globally it is considered an important industry since it helps in the production of support materials for other industries such as

manufacturing and construction. In Nigeria, the quarry industry is a large one with multiple quarrying activity sites present in thirty five states of the country in addition to the federal capital territory. In 2018 alone, the total product output from quarry activities was reported to be more than fifty-four million tonnes (National Bureau of Statistics, 2019). It is considered as one of the most viable production sectors in Nigeria and its socioeconomic impact has been considered quite significant as it serves as a source of employment to more than half a million people (Oladimeji *et al.* 2019; Salawu and Sadiq, 2020). Adeniyi (2021) reported that as at 2014, the industry accounted for 10.6 percent of the country's GDP and 0.2 percent of the total workers employed.

One major occupational safety concern affecting quarry workers is that of Noise Induced Hearing Loss (NIHL) caused from chronic exposure to noise during work activities. It is considered to be the most common form of hearing impairment after presbycusis (Tripathy and Rao, 2017). According to the World Health Organisation (WHO, 2023), hearing loss can be defined as a situation where an individual is unable to hear sounds below 20 decibels (dBA). According to the American National Standards Institute [ANSI] (Anastasiadou and Al Khalili, 2022), NIHL among people exist in different classifications ranging from slight-mild hearing loss (16-40 dBA) to moderate-severe hearing loss (41-90 dBA). The threshold for the noise level beyond which can cause profound impairment and deafness somewhat varies among different regulatory bodies but lies between 80 and 90 dBA (Stevens *et al.* 2011; Humes, 2019; Anastasiadou and Al Khalili, 2022). The NIHL typically begins as secondary hearing losses; a scenario where an individual is unable to hear sounds at high frequencies within the range of 4-8 kHz and if unchecked may deteriorate to hear primary hearing losses where the individual cannot hear sounds at low frequencies (0.5-3 kHz) (Workman-Davies, 1989; Tripathy and Rao, 2017).

In this regard, several research outcomes have reported that a significant proportion of workforce involved in quarry processes are affected by the noise produced by heavy mechanical equipment for activities such as rock blasting, crushing, and power generation. (Ukpong, 2012; Gyamfi *et al.* 2016; Akinluyi *et al.* 2019; Kulabako, 2019). For example, research such as investigating the extent of noise level attenuation provided by personal

protective equipment (Workman-Davies, 1989), assessment of and prediction model development for prediction of noise levels produced by mining equipment (Vardhan *et al.* 2004; Vardhan *et al.* 2006; Phillips *et al.* 2007; Nanda, 2012) and studies to ascertain knowledge, attitude, and practices of workers with respect to noise induced hearing losses (NIHL) (Ismail *et al.* 2013) have all been done.

Further research has also been done to have a broader understanding of this problem with a view to effectively managing its impact on workers. The outcomes from these research indicate that hearing losses from quarry activities generally occur as a function of three major factors namely; the age of a worker, the years of worker's exposure to the noisy conditions and the noise levels at which the worker is exposed (Amedofu, 2002; Kerketta *et al.* 2012a; Nanda, 2012; Ismail *et al.* 2013; Mener *et al.* 2013; Gyamfi *et al.* 2016).

However, the extent in which age, exposure duration and noise level play singularly and interactively in the occurrence of NIHL among quarry workers has been given sparse attention. Nonetheless, a few study exist such as Kerketta *et al.* (2012b) who investigated the effect of the factors on secondary NIHL. Also, Onder *et al.* (2012) investigated the effects of these three factors on the NIHL on quarry workers. However, they were not specific with regards to the hearing frequencies at which the investigation was conducted. Furthermore, Tripathy and Rao (2017) undertook a more comprehensive study of effect of the three factors on the NIHL of mine workers at low and high frequencies.

## **1.2 Statement of the Problem**

Previous literature revealed that some workstations with machine produces high noise level beyond Permissible Exposure Limit (PEL) which subject those workers involved to potential hearing threshold shift (Mulugate, 1992; Boateng and Amedofu, 2004; Ismail *et al.* 2013). In the same vein, quarry workers in Nigeria are exposed to high levels of noise due to the types of equipment used in their daily operation. It is thus a possibility that there will be a certain point or range of a worker's age and exposure length combined with existing noise level, which can lead to irreparable damage to worker's hearing system. As such, there is need to assess the synergistic impact of these factors on the NIHL in quarry workers in Nigeria.



However, information appears sparse regarding the existence of models or procedures to estimate the degree of synergistic interaction of the three factors that provides information on the safe hearing threshold of workers as well as determine their effects on hearing threshold over time in Nigerian quarries. This study is aimed at addressing this problem.

### **1.3 Aim and Objectives of the Study**

The aim of this study is to develop models for predicting workers safe hearing threshold based on the synergistic impact of age, years of exposure and noise level.

The objectives of this study are to:

1. Measure the noise magnitude of the machinery used in quarry operation.
2. Develop predictive models for hearing threshold of quarry workers.
3. Determine the combination of values of age, years of exposure and noise level that can result to the safe hearing threshold of workers.
4. Determine the effects of age, years of exposure and noise level on hearing threshold over time.

### **1.4 Justification for the Research**

A worker with occupational noise induced hearing loss may have problem of effective communication. This can be considered to be a reduction in job performance and cognition (Mohammadi *et al.* 2009). Selection of physiologically fit workers to a particular task enhances productivity with little or no losses. Since every worker has variations in age, years of exposure and noise levels, there may be different physiological differences among them. It will be of high benefit for the worker to engage at the appropriate workstation which cannot contradict their health and well-being status during and after work. More so, an employer wants to ensure an adequate manpower with little or no absenteeism, unnecessary compensations etc.

Data generated from this research work can be used to modify the quarry workstation to ease worker and working environment interactions. Such data, if utilised, will curb the effect of hearing problems which is the main indication of workers exposure to the unacceptable noise level. This could consequently help in framing comprehensive plans towards a safer, more effective and more efficient man-machine system.

This research is also imperative as the present workers and employers in noisy occupational environment in Nigeria may not notice the starting time of the hearing problem because it always starts as a hidden damage. Human response to noise has become a critical problem in these activities since overexposure may cause discomfort, thus, negatively influencing workers social performances, lower productivity or may even pose health risks. The outcome of this study will provide information for decision makers for the purpose of managing quarry workers responses to NIHL better.

### **1.5 Scope and Limitation of the Study**

Only continuous noise from the machinery in the quarry was considered. The workers' race, ethnicity and life style like smoking, alcohol consumption were not considered in this study. It was observed that none of the quarry workers embrace the usage of any hearing protective device (HPD).

### **1.6 Outline of Succeeding Chapters**

The review of relevant literature is presented in chapter two, Chapter three contains the Method of study. Chapter four comprises Results and Discussion, Summary, Conclusion and Recommendations are presented in Chapter five.

## **CHAPTER TWO**

### **LITERATURE REVIEW**

#### **2.1 The problem of Noise**

Due to increasing level of industrialisation, industrial noise is a growing problem. It is very important to be able to quantify and control this noise and as a consequence, its effects on man and its environment. In an environment where noise poses a problem to the general well-being of the people, a safety precaution is needed in order to reduce the effect. Safety devices such as earmuffs and ear plugs can also be used properly even though these do not actually suppress the noise effect on the operator (Bisong *et al.* 2004). An understanding of people's subjective response to noise allows environmentalists' and engineers to reduce noise in more effective ways. For example, noise should be reduced in the ear sensitive frequency range. Noise reduction should be by a magnitude which is subjectively significant.

The most notable effect of occupational noise is permanent loss of hearing due to higher hearing threshold, which can occur on a daily basis over many years in the workplace. Such hearing impairment generally regarded as noise induced hearing loss (NIHL) always occurs gradually and if not noticed, may cause permanent damage.

#### **2.2 Hearing Loss**

This is a phenomenon that occurs when the hearing threshold of a person is above the normal hearing threshold of a healthy person.

##### **2.2.1 Noise Induced Hearing Loss**

Hearing level (HL) is defined as the difference between audibility of a normal person having normal hearing and patient's threshold audibility at a given frequency

(Burtka and Chick, 1997; Ochmann and Piscoya, 2021).

Mathematical expression of Hearing loss is shown in equation (2.1).

$$HL = 10\log\left(\frac{I}{I_o}\right) \text{ (dB)} \quad (2.1)$$

Where,

$I$  = patient's ear threshold sound intensity.

$I_o$  = normal ear threshold intensity.

The most serious pathological effects of noise on workers is the development of excessive hearing threshold leading to hearing loss or complete deafness. Continuous exposure to noise above 90 dBA may lead to the permanent hearing loss which the victims may be unaware of (Asfahl, 2004).

When workers with unprotected ears are exposed to loud noise continuously which are potentially injurious to hearing, the inner ear adapt to the noise firstly by exhibiting a transient threshold shift (TTS) or a permanent threshold shift (PTS) (England and Larsen, 2014). TTS hearing loss occurs within hours to a few days. Therefore, workers should be away from noise for between 24-48 hours before an audiometric testing to avoid the effect of TTS in the test (England and Larsen, 2014). PTS hearing loss is a permanent damage that occurs as a result of irreparable injury to the hearing organ. Hearing frequencies between 3000 Hz and 6000 Hz has maximal injury at 4000 Hz and usually leads to noise - induced deafness (England and Larsen, 2014).

### **2.2.2 Classification of Hearing Loss**

Hearing loss is categorised by World Health Organisation (WHO, 1991) according to the various grade of impairment with corresponding audiometric values and performance as shown in Table 2.1

### **2.2.3 Presbycusis**

It is the progressive age related sensorinueral hearing loss which occasionally occurs around age 40 years (Burtka and Chick, 1997), though early exposure to high noise level may lead to hearing loss more rapidly than aging (Basner *et al.* 2014).

**Table 2.1: World Health Organisation classification of hearing impairment**

|    | <b>Grade of Impairment</b>             | <b>Corresponding Audiometric ISO Value</b> | <b>Performance</b>                                  |
|----|--|--|---|
| 1. | No impairment.                         | 25dB or less                               | No hearing problems, whispers can be heard.         |
| 2. | Slight impairment                      | 26-40dB                                    | Normal voice call can be heard at 1m distance.      |
| 3. | Moderate impairment                    | 41-60 dB                                   | Repeated words can be heard when raised voice at 1m |
| 4. | Severe impairment                      | 61 – 80 dB                                 | Some words can be heard.                            |
| 5  | Profound impairment including deafness | 81 dB or greater                           | Shouted voice cannot be heard and understood.       |

**Source:** WHO (1991)

## **2.3 Effects of Noise on Human Health**

Exposure to higher intensity of noise creates psychological and physiological effect on human being such as anger, stress, acceleration in heartbeat, sleeping disorders, annoyance and increased blood pressure (Cunningham and Tucci, 2017).

### **2.3.1 Annoyance**

W.H.O (2002) identified noise induced annoyance as an adverse health problem. Noise annoyance could be caused by noise-related disturbances of individuals and it is usually linked to negative emotional reactions such as anger, disappointment and displeasure which can cumulatively lead to physiological symptoms. The symptoms are as a result of signals transmitted from the auditory system to the nervous system which enhances several reactions in human bodies (Ouis, 2002). In contrast, people who were working in the noisy occupational environment were found to be less annoyed in this scenario. Furthermore, exposure-response models for combination of noise source are lacking. Also on an individual level, there may be large variations in the annoyance response, depending on exposure modifying annoyance response, depending on exposure modifying factors as well as on personal and situational factors.

## **2.4 Controlling Noise Exposure**

Engineering controls reduces noise exposure by altering or removing the source; administrative control reduces noise exposure by regulating the shift of the workers in lieu of the exposure. PPE helps by protecting the hearing system of the workers by wearing it when the hazard have not been reduced to an acceptable level, therefore audiologist should be able to select the personal hearing protectors and their effective functionalities over exposure to loud noise.

There are standard type of hearing protection established by OSHA for the various workstations which depends on the degree of noise exposure intensity. Earplugs and earmuffs together must be worn when a worker is in high noise level working environment. Hearing protector attenuate noise exposure of the workers in noisy environment. Table 2.2 summarises the minimum levels of protection required by Canadian Standard Association (CSA).

**Table 2.2: Selection of Hearing Protection Devices according to CSA**

| <b>Maximum Equivalent Noise Level<br/>(dBA <math>L_{ex}</math>)</b> | <b>CSA Class of Hearing Protection</b>  |
|---|---|
| $\leq 90$   | C, B or A   |
| $\leq 95$   | B or A  |
| $\leq 100$  | A   |
| $\leq 105$  | A   |
| $\leq 110$  | A earplug +<br>A or B earmuff   |
| $> 110$   | A earplug + A or B earmuff and limited<br>exposure time to keep sound reaching<br>the worker's ear drum below 85dBA<br>$L_{ex}$ |

**Source:**Government of Alberta (2009)

## 2.5 Studies on Age related Noise Effects

Boman *et al.* (2005) analysed noise effects in memory performance in different age groups in order to see whether there are interactions of age with noise in their effects of memory. It was revealed that there were no interaction between noise and age groups indicating that the obtained noise effects were not related to the capacity to perform the task.

## 2.6 Predictive Models for Design Purpose

Different predictive models have been proposed and used many years ago for exploring relationship between two or more variables for design purposes and control. Some number of factors need to be considered in prediction technique selection which is likely to bring about trade-offs; and depends on capability of the models and organizational requirements. Maximisation of the prediction accuracy is the major intent as well as other considerations (Tronto *et al.* 2007).

## 2.7 Multiple Linear Regressions

Many engineering and science research problems involve finding the relationship between two or more variables. Often regression analysis is always suitable for these types of problems. Many regression analysis models are those where there are more than one independent variable; such are called a multiple linear regression models (Montgomery and Runger, 2007). Typical multiple regressor model can be formulated as in equation (2.2)

$$Y = \beta_0 + \beta_1 X_1 + \beta_2 X_2 + \dots + \beta_k X_k + C \quad (2.2)$$

Where:

$Y$  is the dependent variable or response,  $k$  is the number of independent or regressor variables,  $X_i$  is the independent or regressor variable,  $i = 1, 2, \dots, k$  and  $\beta_j$  is the regression co-efficient,  $j = 0, 1, 2, \dots, k$  and  $C$  is a term that includes the effect of unmodelled sources of variability that affect the dependent variable. Therefore, the multiple linear regressor helps to summarise the various relationships involved among the independent variables with the response.



## 2.8 Neural Network Technique

In the last few years, there has been increased interest on the application of Artificial Neural Networks (ANN) to several research problems in science and engineering. They are useful in design solutions, control, classification and estimation of problems and models prediction (Barati-Harooni *et al.* 2016). However, the usage of neural network is disadvantageous due to its inability to represent monotonic relations (Bonissone, 2002).

## 2.9 Adaptive Neuro - Fuzzy Inference System (ANFIS)

The Adaptive Neuro-Fuzzy Inference System (ANFIS), which is based on the first-order Sugeno fuzzy model that uses either a back propagation algorithm alone or a hybrid learning algorithm, consists of both Artificial Neural Network (ANN) and Fuzzy logic (FL). It includes linguistic expressions of membership function (MFs) and if (observation) then (actuation) rules (Tatar *et al.* 2016). ANFIS is a tool that integrates the best features of fuzzy systems and Neural Network (NN).

ANFIS network depends heavily on the choice of process variables involved, the available data set and the domain used for training purposes. Basically, a fuzzy inference system is composed of five functions block (Jang, 1993): (i) a rule based on containing a number of fuzzy if-then rules success (ii) a database which defines the membership function of the fuzzy sets used in the fuzzy rules. (iii) a decision making unit which perform the inference operation on the rules. (iv) a fuzzification inference which transforms the crisp inputs into degrees of match with linguistic values. (v) a defuzzification inference which transforms the fuzzy results of the inference into a crisp output. Assume that the fuzzy inference system has two inputs  $x$  and  $y$  and one output  $f$  for a first-order sugeno fuzzy model, a common rule set with two fuzzy if-then rule operates (Jang, 1993; Dua and Taniskidou, 2017; Nguyen *et al.* 2019).

FIS structure is a network-type structure similar to that of a neural network, which maps inputs through input membership functions and associated parameters to outputs. The parameters associated with the membership functions are modified through learning process. The adjustment of the parameter is generated by the vector gradient. The adjusted parameters are subsequently applied to all optimisation routine to reduce measurement

error. Usually, if  $y_t$  is the current value of period  $t$  and  $F_t$  is the forecast for the same period, then as shown in equation (2.3), the error is defined as:

$$E_t = y_t - F_t \quad (2.3)$$

A mean square error (MSE) as shown in equation (2.4), is defined as:

$$MSE = (1/n) \sum_{t=1}^n (y_t - F_t)^2 \quad (2.4)$$

Where  $n$  is the number of time periods.

ANFIS uses a combination of minimum squares error and back propagation for the estimation of activation function parameters. In other words, ANFIS utilises the advantages of FL and ANN to adjust its parameters and find optimum solutions. Both FL and ANN have their advantages, the marriage of learning capabilities of Neural Network and knowledge representation ability of fuzzy logic has given birth to Fuzzy Neural Networks. As a result, the drawback of neural network blackbox inability to explain decision (lack of transparency), and weakness of learning in fuzzy logic have been conquered (Salleh *et al.* 2017; Talpur *et al.* 2020).

Therefore it is a good idea to combine their ability and make a strong tool which improves their weakness and leads to a minimum error. This popular fuzzy set theory based tool has been successfully applied to many military and civilian areas including decision analysis, forecasting, pattern recognition, system controls (Automated Fuzzy Control Tuning) and models (to explain past data and predict future behaviour), inventory management, logistic systems and operations management (Gheisari *et al.* 2017; Salleh *et al.* 2017; Petković *et al.* 2019; Talpur *et al.* 2020). The non-linearity and structured knowledge representation of ANFIS are its primary advantages over classical linear approaches (Karaboga and Kaya, 2016).

## **2.10 Introduction to the exhaustive search and ANFIS modelling**

Exhaustive search is a general problem-solving technique that consists of systematically enumerating all possible candidates for the solution and checking whether each candidate satisfies the problem's statement (Kisi *et al.* 2018). Exhaustive search is always used to perform a thorough search of input data that best relates with output data to produce the

least training and checking error. Exhaustive search is a combinatorial function which selects the required number of inputs combination to be tried during the search.

Adaptive Neuro Fuzzy Inference System (ANFIS) is a hybrid intelligent system which has the ability of Fuzzy Logic (FL) to reason with Neural Network (NN) to learn (Ilse *et al.* 2020). The goal of ANFIS is to find a model which will simulate correctly the inputs with the outputs. The fuzzy inference system (FIS) is a knowledge representation where each fuzzy rule describes a local behaviour of the system (Amirian, 2019). ANFIS is the network structure that implements FIS and employs hybrid-learning. The basic structure of FIS is a model that maps input characteristics to input membership functions, and the output membership function to a single-value output or a decision associated with the output (Aslan *et al.* 2019).

Using a given input/output data sets, the toolbox function “anfis” in MATLAB constructs a fuzzy inference system (FIS) whose membership function (MF) parameters are tuned (adjusted) using either a back propagation algorithm alone or in combination with a least squares type of method (Karaboga and Kaya, 2019).

### **2.11 Some Application of Adaptive Neuro - Fuzzy Inference System**

The detailed architecture and learning procedure of ANFIS can be found at large in the literature (Jang, 1993; Petkovic *et al.* 2019; Gheisari *et al.* 2019; Talpur *et al.* 2020).

Fuzzy control algorithms and especially ANFIS have been widely applied to predict process parameters or effluent parameters for aerobic biological treatment processes (Murnleitner *et al.* 2002), for forecasting wastewater flow-rates (Fernandez *et al.* 2009), for water management in anaerobic treatment units in sugar factories (Perendeci *et al.* 2007), predicting carbon and nitrogen removal in the aerobic biological treatment for sugar production industry (Civelekoglu *et al.* 2007), predicting suspended solids in the effluent from hospital Waste Water Treatment Plant (Pai *et al.* 2009) and modeling for stock price prediction (Gharakhani *et al.* 2011).

Mingzhi *et al.* (2009) clearly stated that successful practical applications of models developed using ANFIS are generally based on two or three parameter inputs and single output, more so, Talpur *et al.* (2020) stated that ANFIS is always effective when the inputs member is not more than five.

An ANFIS can be viewed as a special three-layer feed forward neural network. The first layer represents input variables, the hidden layer represents fuzzy rules and the third layer is an output. Figure 2.1 represents a typical ANFIS architecture that is based on:

**Layer 1:** Every node in this layer is an adaptive node with a node function that may be a generalized bell membership function, a Gaussian membership function or any membership function.

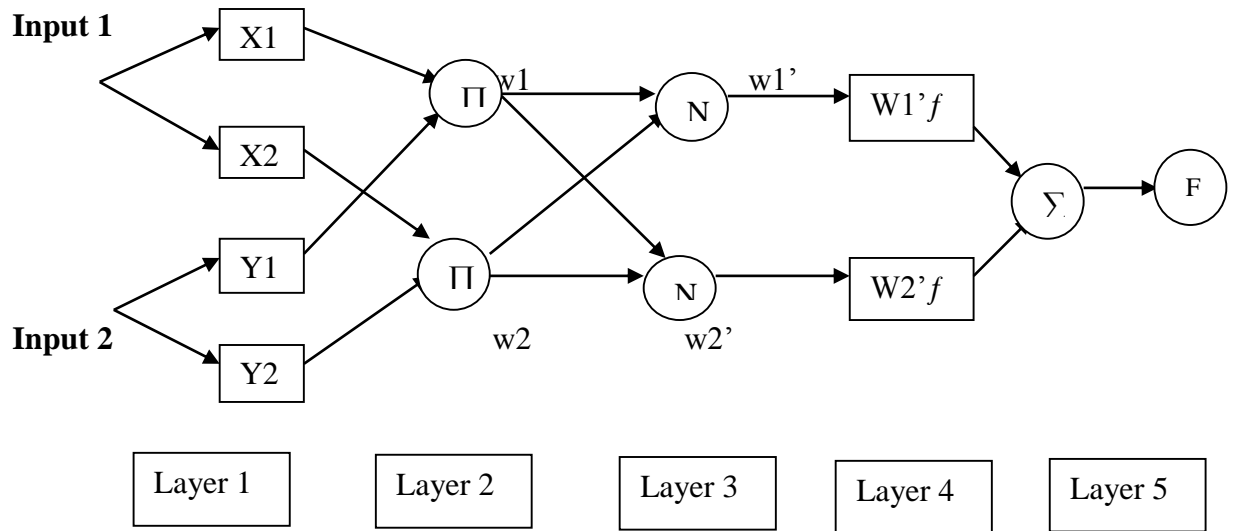
**Layer 2:** Every node in this layer is a fixed node labelled, representing the firing strength of each rule and is calculated by the fuzzy and connective of product of the incoming signals.

**Layer 3:** Every node in this layer is a fixed node labelled N, representing the normalized firing strength of each rule. The  $i^{\text{th}}$  node (1, 2) calculates the ratio of the  $i^{\text{th}}$  rule's firing strength to the sum of the two rules' firing strengths.

**Layer 4:** Every node in this layer is an adaptive node with a node function indicating the contribution of  $i^{\text{th}}$  rule toward the overall output.

**Rule 1:** *If  $x$  is  $x_j$  and  $y$  is  $y_1$ , is  $f_1 = p_1x + q_1y + r_1$*  (2.5)

**Rule 2:** *If  $x$  is  $x_2$  and  $y$  is  $y_2$ , then  $f_2 = p_2x + q_2y + r_2$*  (2.6)



**Figure 2.1: Structure of Adaptive Neuro-Fuzzy Inference System Network with Two Inputs and an Output**

**Source:**Talpur *et al.* (2020)

## 2.12 Response Surface Method Experimental Design

An experiment is a series of tests, called runs, in which changes are prepared in the input variables in order to recognize the reasons for changes in the output response (Montgomery, 2012). The Response Surface Method (RSM) was first developed by Box and Wilson in the statistical field in the 1950s (Huiping *et al.* 2007).

RSM implemented in design expert environment is a collection of mathematical and statistical tools or techniques for designing experiments, optimisation of chemical reactions, agricultural processes, manufacturing processes, biological processes, factorial design, regression analysis, building models, evaluating effects of various factors and searching for the optimum conditions (Li *et al.* 2000; Do *et al.* 2001; Majumdar and Goyal, 2008; Kansedo *et al.* 2009; Ferilla *et al.* 2010).

RSM is a mathematical and statistical technique used to evaluate the relationship between one or more dependent variables (response) and a number of independent variables (factors) at a shorter time with less cost (Diniz and Martin, 1996; Vohra and Satyanarayana, 2002; Myers *et al.* 2009; Montgomery, 2012; Awolu *et al.* 2013). Its approach is useful in deriving approximation models from a number of physical experiments useful for optimum condition searching and improvement, mathematical modeling, interaction between factors, identification and examining engineering problems where certain number of variables have effect on response of concern, and producing multivariable equations (Shang and Tadikamalla, 1993; Myers *et al.* 2009; El-Tayeb *et al.* 2010; Tala-Ighil *et al.* 2011; Abbasi & Mahlooji, 2012; Wu *et al.* 2012).

## 2.13 Analysis of a First-Order Response Surface

The relationship between the response variable  $y$  and the independent variables are usually unknown. In general, the low order polynomial model is used to describe the response surface  $f$ . A polynomial model is usually a sufficient approximation in small regions of the response surface. Thus, depending on the approximation of unknown function  $f$ , either first-order or second-order model are employed. Furthermore, the approximated function  $f$  is a first-order model when the response is a linear function of independent variables. A first-order model with  $N$  experimental runs carried out on  $k$  design variables and a single response  $y$  can be expressed as in equation (2.5).

$$Y_i = \beta_0 + \beta_1 X_{i1} + \dots + \beta_k X_{ik} + \epsilon \quad (2.5)$$

Where,

$$(i = 1, 2, 3, \dots N)$$

The response  $Y$  is a function of the design variables  $X_{i1}, X_{i2}, \dots, X_{ik}$  denoted as  $f$ , plus the experimental error  $\epsilon$ . A first-order model is a multiple-regression model and the  $\beta_i$ s are regression coefficients. A second-order model is useful in approximating a portion of the true response surface with parabolic curvature. The second-order model includes all the terms in the first-order model, plus all quadratic terms like  $\beta_{11}X_{1i}^2$  and all cross product terms like  $\beta_{13}X_{1i}$ . It is usually expressed as shown in equation (2.6).

$$Y = \beta_0 + \sum_{i=1}^k \beta_i + \sum_{i < j}^k \beta_{ij} X_i X_j + \sum_{i=1}^k \beta_{ii} X_i^2 + \epsilon \quad (2.6)$$

The second-order model is flexible, because it can take a variety of functional forms and approximates the response surface locally. Therefore this model is usually a good estimation of the true response surface. In addition to the first and second order models, general polynomial models can also be used to regress the response surface. All kinds of polynomial response surface models can be rewritten as an equation in matrix form as shown in equation (2.7):

$$\mathbf{y} = \mathbf{X}\boldsymbol{\beta} + \epsilon \quad (2.7)$$

Where

$$\mathbf{y} = \begin{Bmatrix} Y_1 \\ Y_2 \\ \vdots \\ \vdots \\ \vdots \end{Bmatrix} = \begin{Bmatrix} 1 & x_{11} & x_{12} & \dots & x_{1m} \\ 1 & x_{21} & x_{22} & \dots & x_{2m} \\ \cdot & \cdot & \cdot & \cdot & \cdot \\ \cdot & \cdot & \cdot & \cdot & \cdot \\ \cdot & \cdot & \cdot & \cdot & \cdot \end{Bmatrix} \cdot \begin{Bmatrix} \beta_0 \\ \beta_1 \\ \vdots \\ \vdots \\ \vdots \end{Bmatrix} + \begin{Bmatrix} \epsilon_0 \\ \epsilon_1 \\ \vdots \\ \vdots \\ \vdots \end{Bmatrix} \quad (2.8)$$

Equation (2.7) is a vector form of (2.8). For  $x_{ij}$  in equation (2.8),  $x$  represents the linear terms, square terms and linear by linear interactions items in equation (2.6),  $i$  represents the  $i^{\text{th}}$  group data of regress,  $j$  represents the  $j^{\text{th}}$  response term in equation (2.6)

In general all RSM problems use either one or a mixture of these models. In each model, the levels of each factor are independent of the levels of other factors. In order to get the most efficient result in the approximation of polynomial the proper experimental design must be used to collect data. Once the data are collected, the method of least square is used to estimate the parameters in the polynomials. The response surface analysis is performed by using the fitted surface. The response surface designs are types of designs for fitting response surface.

Therefore, the objective of studying RSM can be accomplished by

- (i) Understanding the topography of the response surface (local maximum, local minimum, ridge lines), and
- (ii) Finding the region where the optimal response occurs. The goal is to move rapidly and efficiently along a path to get to a maximum or a minimum response so that the response is optimised.

The analysis of a second-order model is usually done by computer software. The analysis of variance for fitting the data to the second-order and the contour plots will help characterise the response surface.

The RSM optimisation procedure is as follows (Oehlert, 2000):

- (i) Plan and run a typical design near or at the current operational variables.
- (ii) Fit a linear model (no interaction or quadratic terms) to the data.
- (iii) Determine path of steepest ascent (PSA) which is a quick way to move to the optimum conditions.
- (iv) Run tests on the PSA until response no longer improves.
- (v) If curvature of surface is large go to step (vi), else go to step (i).
- (vi) Neighbourhood of optimum – design, run and fit (using least squares) a 2<sup>nd</sup> order model based on 2<sup>nd</sup> order-pick optimal settings of independent variables.

There are several design types available in RSM: Box – Behnken, Central – composite, one – factor, optimal and historical data (Montgomery and Runger 2007).



## 2.14 Historical Data Design for the Response Surface

Historical data design (HDD) type can accommodate all available data into a blank design layout from an already conducted experiment (Jeirani *et al.* 2013). It is also suitable for conducting multi-factor experiments because it provides information on the influence of factor interactions (Asmara, 2013). Salam *et al.* (2018) employed HDD in RSM for the modeling and optimisation of sand minimum condition in pipeline multiphase flow by obtaining the past experimental data from reputable archive, which gave appropriate empirical model for relating the operational parameters, and good prediction of operating conditions affecting their response.

Ighalo *et al.* (2020) used HDD on Design Expert in modelling the effect of Sorbate Sorbent interphase on the adsorption of pesticides and herbicides. Their result yielded a good response model with dataset that were obtained from several retrospective reputable published papers in the previous five years, having using sixty six lines of data for analysis using RSM.

Good results were also recorded when HDD tool box in the Design Expert software was used for modeling of interactions between or among variables when design of experiment approach was not used to design before the start of experiment. Some of such reported works are Aremu *et al.* (2014), Salam *et al.* (2015), Salam *et al.* (2018), Salam *et al.* (2020), where HDD in the Design Expert software was used for model development and captured the interactions among variables.

## 2.15 Multiple Reponses: The Desirability Approach

The desirability function approach is one of the most widely used methods in industry for the optimisation of multiple response processes. It is based on the idea that the ‘quality’ of a product or process that has multiple quality characteristics, with one of them outside of some ‘desired’ limits, is completely unacceptable (Derringer and Suich, 1980; Bobadilla *et al.* 2017; Gómez *et al.* 2017; Lostado-Lorza *et al.* 2018). The method finds operating conditions  $x$  that provide the ‘most desirable’ response values.

For each response  $Y_i(x)$ , a desirability function assigns numbers between 0 and 1 to the possible values of  $Y_i$  with  $d_i(Y_i) = 0$  representing a completely undesirable value of  $Y_i$

and  $d_i(Y_i) = 1$  representing a completely desirable or ideal response value. The individual desirability is then combined using the geometric mean, which gives the overall desirability  $D$ .

$$D = (1.1 \dots 2.2)k.k^{-1/k} \quad (2.9)$$

with  $k$  denoting the number of responses. Notice that if any response  $Y_i$  is completely undesirable ( $d_i(Y_i) = 0$ ), then the overall desirability is zero. In practice, fitted response values  $\hat{Y}_i$  are used in place of  $d_i$ .

Depending on whether a particular response  $Y_i$  is to be maximised, minimised, or assigned a target value, different desirability function  $d_i(Y_i)$  can be used. A useful class of desirability functions was proposed by Kuhn (2013). Let  $L_i, U_i$  and  $T_i$  be the lower, upper, and target values, respectively, that are desired for response  $Y_i$ , with  $L_i \leq T_i \leq U_i$

If a response is of ‘target is best’ kind, then its individual desirability function is

$$d_i(\hat{Y}_i) = \begin{cases} 0 & \text{If } \hat{Y}_i(x) < L_i \\ \left( \frac{\hat{Y}_i(x) - L_i}{T_i - L_i} \right)^s & \text{If } L_i \leq \hat{Y}_i(x) \leq T_i \\ \left( \frac{\hat{Y}_i(x) - U_i}{T_i - U_i} \right)^t & \text{If } T_i \leq \hat{Y}_i(x) \leq U_i \\ 0 & \text{If } \hat{Y}_i(x) > U_i \end{cases} \quad (2.10)$$

with the exponents  $s$  and  $t$  determining how importance it is to hit the target value. For  $s = t = 1$ , the desirability function increases linearly towards  $T_i$  for  $s < 1, t < 1$ . the function is convex, and for  $s > 1, t > 1$ , the function is concave.

If a response is to be maximized instead, the individual desirability is defined as

$$d_i(\hat{Y}_i) = \begin{cases} 0 & \text{If } \hat{Y}_i(x) < L_i \\ \left( \frac{\hat{Y}_i(x) - L_i}{T_i - L_i} \right)^s & \text{If } L_i \leq \hat{Y}_i(x) \leq T_i \\ 1.0 & \text{If } \hat{Y}_i(x) > U_i \end{cases} \quad (2.11)$$

with  $T_i$  in this case interpreted as a large enough value for the response.

Finally, if response is to be minimized, we could use

If a response is to be maximized instead, the individual desirability is defined as

$$d_i(\hat{Y}_i) = \begin{cases} 1.0 & \text{If } \hat{Y}_i(x) < T_i \\ \left( \frac{\hat{Y}_i(x) - U_i}{T_i - U_i} \right)^s & \text{If } T_i \leq \hat{Y}_i(x) \leq U_i \\ 0 & \text{If } \hat{Y}_i(x) > U_i \end{cases} \quad (2.12)$$

with  $T_i$  denoting a small enough value for the response.

The desirability approach consists of the following steps:

1. Conduct experiments and fit response models for all  $k$  responses;
2. Define individual desirability functions for each response; and
3. Maximize the overall desirability  $D$  with respect to the controllable factors.

### 2.16 Previous Noise Related Research done Using Artificial Intelligence methods

Adaptive fuzzy model was developed for noise prediction using genetic algorithm based on the adoption of the Takagi and Sugeno, (1985); optimisation phase approach (Caponetto *et al.* 1997). It was concluded that genetic algorithm based fuzzy model gave results with unacceptable computational value.

Fuzzy model for noise annoyance prediction was formulated by Verkeyn *et al.* (2001). Their fuzzy rule based model was for the prediction of traffic noise annoyance. Several inferences were compared with the prediction capacity. At end of the designed mode, a genetic algorithm was applied.

Neural networks were used for the classification of urban environmental noise by Stoeckle *et al.* (2001). The main objective of their research was to create new ways of monitoring of the complex urban environmental noise. Fast Fourier transform method was used to produce spectral data of sounds from different sources for the classification using neural networks. Zaheeruddin *et al.* (2003) conducted a research on the effects of noise pollution on human work efficiency. Noise level, exposure time and types of tasks were set as variables, the effects of age of the workers were not considered. The results of their model showed that exposure time, noise level and nature of task can predict the work efficiency.

Kolarik *et al.* (2004) studied the human performance assessment in the noisy environment by developing knowledge-based assessment approach in dealing with uncertainty and

subjectivity involved. The fuzzy knowledge was also used to offer reliability assessment at the dynamic circumstances.

Zaheeruddin *et al.* (2006) applied a fuzzy model to predict annoyance caused by noise. The fuzzy model represented the inputs and outputs relationship in the form of simple IF-THEN rules. The model predicted noise level, duration of occurrence and the socioeconomic status of a person as a predictor of the annoyance. The fuzzy logic toolbox of MATLAB was used to implement the model also using Takagi and Sugeno (1998) techniques.

Aluclu *et al.* (2008) conducted comprehensive field studies on noise measurement with consideration for the element of control measures. Noise reduction quantity in decibels was incorporated as two subsystems in the model. Acoustical features of the materials used in the working place were considered as the first subsystem of the fuzzy model. The second subsystem involves the atmospheric parameter interactions.

The models were trained in many stages, with many patterns testing as well, which were determined by considered formal standard measurement using pattern and specialist experiences. The model result was compared with those produced by various statistical tools (correlation, max-min, average, and skewers coefficient) and error mode (error, relative error and root mean square). The error modes were low with significantly high correlation coefficient while other statistics were much closer to the data.

Zaheeruddin and Jain (2008) investigated the effects of noise pollution in speech interference by developing an expert system by fuzzy application. Speech interference was measured in terms of speech intelligibility as a function of noise level, distance between speaker and listener, and the listener's age. The main source of model development is the reports of World Health Organisation (WHO) and field surveys conducted by various researches which was implemented on Fuzzy logic Toolbox of MATLAB using both Mandani and Sugeno Techniques. The results are found to be in good agreement with the findings of W.H.O. and U.S. Environmental Protection Agency (EPA). The study reveals that for good communication at normal distances (short and medium) encountered in ambient environment, the noise level should not exceed 65dBA for young and middle aged, and 55dBA for old persons. MATLAB was used to develop the models by also

using both Takagi and Sugeno (1998) techniques. Their results showed that in normal distance communication in ambient environment, the noise level should not exceed 65 dBA for young and middle ages, and 55 dBA for old persons. Their model also established the usefulness of the fuzzy techniques in studying the environmental problems.

Noise pollution effect on human work efficiency was predicted as a function of age, noise level and years of exposure of the machine operators in a construction company. A fuzzy model was used to compute, analyse and establish the models. The inputs and outputs relationship system was represented in the form of IF-THEN rules (Mallick *et al.* 2009). The interactions of the inputs parameters were not considered and no major predictor was pronounced.

Ojolo and Ismail (2011), modeled the effects of noise on machine operators. Major hearing losses were traced to noise generated by machinery. The results showed that hearing loss increases with increase in frequency of exposure and age. Additional influencing factors such as the loudness level and sound intensity were also reported. A fourth order Newton difference scheme was used in modeling, the result was simulated using MATLAB program with the operator's age as the major factor.

Torija *et al.* (2012) predicted sound pressure level of urban environments by using back-propagation neural networks. The neural network indicated a good precision in prediction which has been proved to be more effective than the usage of Multi Linear Regression (MLR).

Bouloiz *et al.* (2013) established the combination of fuzzy logic and dynamic system of a human factor influenced work environment. The environment studied contained a set of variables that influence human behaviour in the context of industrial safety. The uncertain nature and qualification of the variables value were obtained with the fuzzy logic serving as a tool and used for modeling the behaviour of human factor.

Maccà *et al.* (2015) used multivariate analysis to investigate the effects of age, occupational sound and noise exposure in high frequency hearing threshold, they showed that age was the primary predictor; and noise and exposure as the secondary predictors in the high frequency range. The result only highlighted one factor at a time and concluded

that age was the only determinant, without checking for other possible combination of other factors.

Akanbi and Oriolowo (2016) explored the impact of occupational noise safety of quarry workers, their work showed that workers were exposed to a high level of noise at their workstation. It was concluded that the age of the workers was the major contributory factor in hearing threshold prediction. Their work was also based on a single factor analysis with non-consideration for interacting effects.

Akanbi *et al.* (2021) studied the contributions of age of the workers, years of exposure and noise level on the hearing threshold as well as their interactive effects, using statistical design in selecting factors. The reported results indicated that the degree of prediction and contribution of the three independent variables was the highest with noise level and least with the age.

A summary of the previous work regarding the effect of noise on hearing threshold is summarised in Appendix A.

### **2.17 Research Gap**

Though many research work including the aforementioned have been conducted in the area of the factors affecting hearing threshold (age, years of exposure and noise level), this study is yet to find literature that establish the degree of combinations of the age, years of exposure and noise level that simultaneously lead to the specific values of hearing threshold of workers at their workstations. However, this present study predicted the combined range of values of age, years of exposure and noise level exposure for a worker that correspond to the safe hearing threshold in the quarry. This will allow the possibility of predicting a fit worker's hearing threshold at a particular frequency as well as establishing the impact of the interactive factor.

## **CHAPTER THREE**

### **METHODOLOGY**

#### **3.1 Criteria for the Measurement of Sound**

Noise measurement in this study was carried out in accordance with the Canadian Standard Association (CSA) noise measurement standard Z107.56– 06 procedures (Occupational Health and Safety, 2014). All tools and equipment used in this study were evaluated using standard procedures, pretested and revised to ensure their validity and reliability.

Four approaches were adopted for data collection:

- (i) Subject selection at the selected quarries and self – reported questionnaire / interview (Appendix B: Consent and voluntary participation form; and Appendix C: Questionnaire on hearing threshold for the quarry workers).
- (ii) Measurement of the noise emitted at the quarry which workers were exposed to when machine are in operation (Appendix D: 2018 Experiment; and Appendix E: 2019 Experiment).
- (iii) Audiometric measurement of each subject by a consultant in the laboratory to determine hearing threshold of each participant in the study (Appendix D: 2018 Experiment; and Appendix E: 2019 Experiment).
- (iv) The process was replicated in a year duration interval to be able to make decision on time - bound impact of noise on the subjects (Appendix E: 2019 Experiment).

The following equipment were used for the data collection during the two years experiment:

Digital Sound level meter (TESTO 815, Test Equipment Depot, United State of America) with sound calibrator (TESTO

816, Test Equipment Depot, United State of America) and sound proofing testing booth (TRIVENI TAM-10 5100B, Golden Ears Audiology, Delhi).

### **3.1.1 Subject selection**

In the months between June and July 2018, based on random sampling, two hundred and four were selected from 271 workers in the four quarry sites from production section; the remaining 67 subjects were not available during the sampling time. Thirty five (35) other subjects were also selected from the non-production section as control (Appendix E). This represented 75.30% of the population of the quarry workers in the production section and was considered reasonably adequate, since this percentage more than satisfies the recommended range (Suskie, 1996; Nardi, 2003; Neuman, 2007) (Appendix F).

Follow up research arrangement was conducted from September – October, 2019 with one hundred and eighty five (185) subjects of the production section out of the 204 who participated in the study in the year 2018; the remaining 19 subjects were not available during this sampling period. 30 out of the 35 from non-production section that participated in the year 2018 were also available for sampling again (Appendix E). This arrangement was carried out in order to verify whether there is change or not in the hearing threshold of the same workers that participated in the experiment in two consecutive years of this study.

Workers from different sections in each quarry were selected. No preselecting process was undertaken and all subjects had the purpose and the experimental procedure explained to them. The permission of the quarries management was obtained before the study commenced. Participants were notified several days before the study began, followed by questionnaire which was administered before data collection began. The workers in this study had completely rested for more than 48 hours after their day shift in order to prevent transient hearing loss.



### **3.1.2 Assessing noise levels**

This study considered the operators that are exposed directly to the following noise emitted equipment: Primary Crushers, Secondary Crushers, Dumpers, Payloader, Wagon drilling machine, Lathe, Drilling Machine and Excavator. Their operations were used in categorizing the workers into ten groups: Primary Crusher, Secondary Crusher, Compressor, Dumper, Wagon Drilling, Pay loader, Lathe, Drilling Machine and Excavator operators and Administrative staffs. With the location of noise sources, the noise levels which workers are exposed to were assessed with ethical approval. Individual workers' noise exposure level over eight hours at an hour intervals were measured.

Digital Sound Level Meter (TESTO 815, Test Equipment Depot, United State of America) was used to measure the sound level with sound calibrator (TESTO 816, Test Equipment Depot, United State of America) (Plate 3.1a and 3.1b respectively) was used to calibrate the sound level meter to the appropriate level, in conformity to the American National Standard Institute, ANSI, and Standard SI. 4 – 2006 (IAPA, 2008) for the purpose of assessing noise levels.

#### **3.1.2.1 Procedure followed in measuring noise exposure with sound level meter**

In measuring the noise exposure in the quarries, the following procedure was adhered to:

- (i) The correct use of the microphone was ensured in obtaining accurate measurements by pointing it directly at the sound source;
- (ii) Measurements were taken at 1.5m above the ground and 3m from the noise source with microphone mounted on a conventional tripod of substantial construction.
- (iii) Reflecting and obstacles objects were avoided.
- (iv) Measurements were made when the average wind speed measured with Cup Anemometer (GS026, Texas, United State of America) was less than 5m/s;
- (v) A microphone windshield was used for all outdoor measurements.
- (vi) Air temperature was between 18.1°C and 32.5°C
- (vii) There was no background noise level differences greater than 10 dBA

### **3.1.2.2 Noise exposure assessment**

Regarding the noise exposure assessment, the digital Sound Level Meter (TESTO 815, Test Equipment Depot, United State of America) (Plate 3.1a), with sound calibrator (TESTO 816, Test Equipment Depot, United State of America) (plate 3.1b) was used to calibrate the sound level meter to the appropriate level, in conformity to the American National Standard Institute, ANSI, and Standard SI. 4 – 2006 (IAPA, 2008) for the purpose of noise exposure measurement. The fast response setting of the digital Sound Level Meter was used in this work since it measures how noise fluctuates over time rather than noise exposure (OHS, 2014). It consists of a microphone that converts sound pressure variations into electrical signals. Any form of vibration, excessive heat and shock that may occur on field were prevented by the calibrator attached to the microphone. The reading was then compared with the calibrator's value. The sound level meter was adjusted when required to bring it into calibration. For each particular application, the measurement technique was carefully chosen and controlled to obtain accurate and consistent results.



**Plate 3.1a: Sound level meter (TESTO 815, Test Equipment Depot, United State of America)**



**Plate 3.2b: Sound callibrator (TESTO 816, Test Equipment Depot, United State of America)**

### **3.1.2.3 Measurement of pure tone audiogram / hearing status (Audiometric test)**

This test was conducted in an audiogram sound proofing testing booth (TRIVENI TAM - 10 5100B, Golden Ears Audiology, Delhi) (Hoffman *et al.*, 2017), on each subject at the hospital in Ibadan by a specialist. Audiometric air conduction tests were performed by presetting a pure tone at frequencies of 250, 500, 1000, 2000, 3000, 4000, 6000 and 8000 Hz, since this range of frequency encompasses the speech frequencies, are the most important range of communication and the aim of using these frequencies were not for medical management (ASHA, 1990; ANSI, 2004; ASHA, 2004; Healthy hearing.com, 2020) at 5 dBA interval to the ear of the participant through an earphone. The lowest tone that participants responded to, known as hearing threshold (dB), was recorded at that frequency. Hearing was considered normal if the threshold level was less than or equal to 25 dBA at the selected frequency. The stimuli intensity was increased beyond 25 dBA at any frequency until a response was obtained. Intervals of 5 seconds duration were maintained between the tones. The average preset tone duration was 3 seconds. The average time used to perform the audiometric test on a subject was 5 minutes.

### **3.2 Test of Variance between the 2018 and 2019 Dataset**

The data collected from the subjects at all quarries consisted of 204 in the year 2018 and 185 data points in year 2019. These were subjected to a test of variance in order to ascertain if there was similarity (or not) between the 2018 and 2019 dataset in terms of the age, years of exposure, noise level and hearing threshold (Appendix G).

### **3.3 Exhaustive Search and ANFIS modelling on the Data**

Exhaustive search was performed to determine the most significant parameters (among age, years of exposure and noise level) as shown in Figure 3.1

The syntax structure of exhaustive search is:

```
[input_index, elapsed_time] = exhsrch(in_n, trn_data, chk_data, input_name, mf_n, epoch_n)
```

Where input\_index: index of the inputs selected by exhaustive search,

Elapsed\_time: time in input selection, in\_n: number of inputs to be selected from the input candidates (restricted to be 1...3); trn\_data: original training data; chk\_data: original checking data; input\_name: input name for all input candidates; mf\_n: number of membership function for each input; epoch\_n: number of training epochs for ANFIS (default to 1).

The ANFIS model Graphical User Interface (GUI) is being partitioned into four parts and this accounts for the steps involved in using this model. These parts are: Load data points, generate FIS, train FIS and test FIS (Kisi *et al.* 2018).

#### **(A) Load Data Points**

Here, the data is partitioned into two equal halves called the training data and checking data using MATLAB toolbox. The training data consists offset of odd number values between 1 and the total data points while the checking data consists of set of even number values from 2 to the total data points. These data sets were then loaded into the ANFIS GUI by specifying the data type (training or checking), selecting the data from a file or the MATLAB workshop and then clicking load data.

#### **(B) Generate FIS:**

The initial FIS model used in ANFIS training is being generated by choosing either a grid partition (which generates a single-output Sugeno type FIS by using grid partitioning on the data) or Sub-clustering (which generates an initial model for ANFIS training by first applying subtractive clustering on the data). In this work grid partition technique was adopted in order to produce all possible rules to interpret the problem for better accuracy (Talpur *et al.* 2020). Grid partition technique is most often adopted in order to produce all possible rules to interpret the problem for better accuracy (Talpur *et al.* 2020). Grid partition technique generates FIS structure from the data loaded into the GUI, with the number of input membership function, input MF type and output MF type.

**(i) Data:** - is the training data matrix, which must be entered with all but the first columns representing input data, and the last column representing the single output.

**(ii) Number of input MF:** is a vector whose coordinates specify the number of membership functions associated with each input. If one want the same number of

membership functions to be associated with each input, then specify numMFs as a single number. The number of MF used in this work is 2 for all the inputs.

**(iii) Input MF type:** is a string array in which each row specifies the membership function type associated with each input. This can be a one-dimensional single string if the type of membership functions associated with each input is the same. These input MF type are trimf, trapmf, gbellmf, gaussmf, gauss2mf, pimf, dsigmf and psigmf.

**(iv) Output MF type:** is a string that specifies the membership function type associated with the output. There can only be one output, because this is a Sugeno-type system. The output membership function type must be either linear or constant. The output MF type used in this work is constant.

### **(C) Train FIS**

In training the FIS model generated, the steps involved are: choosing of optimization method which is either hybrid or back propagation (The hybrid method was used in this work because is a combination of least-squares and back propagation gradient descent method), enter the number of training Epochs and the training Error Tolerance to set the stopping criteria for training. The training process stops whenever the maximum epoch number is reached or the training error goal is achieved and finally click Train Now to train the FIS. This action adjusts the membership function parameters and displays the error plots.

### **(D) Test FIS**

After the FIS is trained, the model was validated using a Testing or Checking data that differs from the one used to train the FIS. This action plots the data against the FIS output.

## **3.4 Presentation and Analysis of the Models**

The data collected from the respondents were subjected to the predictive ability of exhaustive search in ANFIS training using MATLAB statistical software to determine significant parameters and then made predictions. The input variables were age, exposure and noise level while the output variable was the hearing threshold at different frequency levels (250 Hz, 500 Hz, 1 kHz, 2 kHz, 3 kHz, 4 kHz, 6 kHz and 8 kHz). Each response was analysed separately. The methodology involved in the ANFIS training is Grid

Partitioning 'genfis1'. Different input MF types were used for data training and model analysis. The data partitioning involved a set of odd data point for training, and even number dataset as checking data as shown below.

Training\_data = Data (1:2: end,:)

Checking\_data = Data (2:2: end,:)

### **3.4.1 ANFIS training models for hearing threshold at different frequency levels**

Train 3 ANFIS models, each with 1 input selected from 3 candidates for each frequency.

#### **Frequency 250Hz**

ANFIS model 1: Age --> trn=20.8637, chk=4.9711

ANFIS model 2: Exposure --> trn=20.8669, chk=4.9517

ANFIS model 3: Noise levels --> trn=20.8236, chk=4.9775

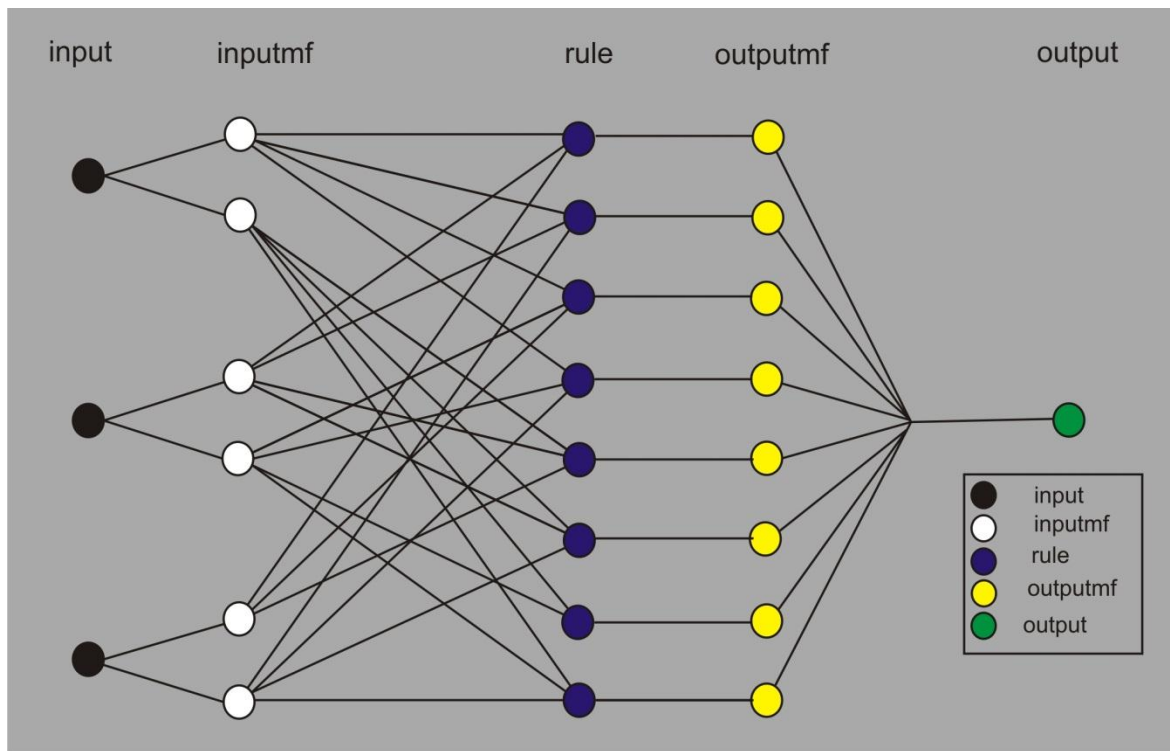
#### **Frequency 500Hz**

ANFIS model 1: Age --> trn=3.4141, chk=4.3273

ANFIS model 2: Exposure --> trn=4.0431, chk=4.5444

ANFIS model 3: Noise levels --> trn=4.6568, chk=5.8254





**Figure 3.1: ANFIS architecture for input and output factors**

### **Frequency 1 kHz**

ANFIS model 1: Age --> trn=3.9118, chk=5.2127

ANFIS model 2: Exposure --> trn=4.3799, chk=5.2967

ANFIS model 3: Noise levels --> trn=6.2289, chk=7.0524

### **Frequency 2 kHz**

ANFIS model 1: Age --> trn=4.5750, chk=5.9657

ANFIS model 2: Exposure --> trn=5.5594, chk=6.1661

ANFIS model 3: Noise levels --> trn=7.5085, chk=8.4801

### **Frequency 3 kHz**

ANFIS model 1: Age --> trn=5.4766, chk=5.7943

ANFIS model 2: Exposure --> trn=6.3557, chk=6.1224

ANFIS model 3: Noise levels --> trn=8.9625, chk=9.5787

### **Frequency 4 kHz**

ANFIS model 1: Age --> trn=8.0740, chk=8.2335

ANFIS model 2: Exposure --> trn=8.9899, chk=8.4371

ANFIS model 3: Noise levels --> trn=15.2515, chk=15.1411

### **Frequency 6 kHz**

ANFIS model 1: Age --> trn=6.8546, chk=6.7931

ANFIS model 2: Exposure --> trn=7.4352, chk=7.3413

ANFIS model 3: Noise levels --> trn=11.2867, chk=11.2389

### **Frequency 8 kHz**

ANFIS model 1: Age --> trn=7.0140, chk=7.5989

ANFIS model 2: Exposure --> trn=7.9421, chk=7.8937

ANFIS model 3: Noise levels --> trn=11.5548, chk=11.0229

## **3.4.2 Model development**

In order to develop models that are suitable for generating difficult to estimate parameters from easy to estimate ones needed to predict the hearing threshold, it is necessary to select the combinations of age, years of exposure and noise level that are relevant to solve the

model approximation task. The following section presents the procedures for the selection of regression model inputs, regression modeling and model's assumption.

### 3.4.3 Selections of regression model inputs

The number of inputs to a model increases its complexity. Therefore, in order to circumvent the problems associated with a complex model, it becomes pertinent to select the most influential inputs. According to Passino and Yurkovich (1998), it is quite difficult to figure out how the inputs should be selected such that the input dataset would be adequate to solve the model approximation task. However, exhaustive search method, seeks the best combination of the age, years of exposure and noise level that influences the hearing threshold the most. Exhaustive search method in MATLAB's Fuzzy Logic Toolbox (MATLAB Toolbox, 2009) builds an ANFIS model for each combination, trains it for one epoch, and reports the performance achieved.

In this study, the exhaustive search method was applied to select the best among the predictors (age, years of exposure and noise level) for each of the responses (hearing threshold). Exhaustive search reveals the best predictors (among age, years of exposure and noise level) that yield the least Root Mean Square Error (RMSE) as in equation (3.1); as well as evaluated using correlation coefficient (R) as in equation (3.2) (Abdulkadir *et al.* 2018). However, in selecting the best combination of age, years of exposure and noise level, two choices criteria were investigated. These are the minimum training RMSE and minimum checking RMSE, and the minimum difference between the training and checking RMSE. These measure were necessary, in a bid to avoid over fitting.

$$RMSE = \sqrt{\frac{1}{N} \sum (obs - pre)^2} \quad (3.1)$$

$$R = \frac{\sum (obs - obs')(pre - pre')}{\sqrt{\sum (obs - obs')^2 \sum (pre - pre')^2}} \quad (3.2)$$

Where,

obs = observed values; pre= predicted values; obs'= average value of observed values; pre' = average value of predicted values.

### 3.4.3.1 Regression modelling

The obtained data was fitted to a second order polynomial regression model as presented in equation (3.3). This task was separately performed for each of the response variables (hearing threshold), using the selected predictors (age, years of exposure and noise level) as inputs.

$$Y = \beta_0 + \sum_{i=1}^k \beta_i X_i + \sum_{i < j}^k \beta_{ij} X_i X_j + \sum_{i=1}^k \beta_{ii} X_i^2 + \epsilon \quad (3.3)$$

For each response, the statistical significance of the regression model terms was evaluated by ANOVA partial SS (Type III). Also the models' predictive performances were checked by lack-of-fit test,  $R^2$ ,  $Adj R^2$ ,  $Pred R^2$ ,  $Adeq$  Precision and  $F$ -test. The significance of the  $F$ -Value was adjudged at 95% level of confidence. The lack of fit is a measure of the failure of a model to represent data in the experimental domain at which points were not included in the regression or variations in models cannot be accounted for by random error (Montgomery, 2012)

The occurrence of a low probability value indicates a significant lack of fit which indicates that the response predictor should be discarded. The  $R^2$  is known as Coefficient of Determination, it shows how much of the dependent variable is accounted for by the independent factors (Montgomery, 2012). Coefficient of variation (CV) indicates the relative dispersion of the experimental points from the prediction of the model.

Statistical Package Design Expert version 6.0.8 was used to obtain response surfaces and contour plots. The numerical and graphical optimisations were also performed by the same software for the clarity on the interaction relationship of age, years of exposure on noise level. The regression models were used to predict the response (hearing threshold) based on the values of the predictors (age, years of exposure and noise level). The degree of correlation between the predicted hearing threshold and actual values was also examined in order to ensure the model accuracy.

### 3.4.3.2 Model assumption

The following assumption are laid down to construct the prediction models.

- (i) The subjects were quarry workers.
- (ii) All the dependent (response) variables: age, years of exposure and noise level.

### **3.4.4 Statistical analysis**

This work follows three (3) important phases which could be used to make a meaningful study, the experimental or planning phase, the design phase and the analysis phase. A Historical Data Design (HDD) was used to set up and optimise the experimental data. Design-Expert version 6.0.8 was used for the modelling of the identified variables. Analysis of variance (ANOVA) was used for the analysis of the data obtained from this experiment for frequencies 250Hz – 8000Hz. The ANOVA is labelled “sum of squares” is Type III – partial. This approach to ANOVA done by default, causes total sums – of – squares (SS) for the terms to come up short of the overall model when analysing data from a non-orthogonal array as in historical data.

The SS terms does not add up to the model (SS) so that sequential (Type I) sum of squares is formed. Approach is not good because it favours the first term fit into the model. ANOVA by partial SS (Type III) calculates  $\text{prob} > F$   $p$ -value. Recalculating ANOVA by sequential sum of squares (Type I) always elevates the level of significant only because main effect of factor is usually fit first; which is not correct (Statease.com). The interaction between (age, years of exposure and noise level); and the response of different regression models developed for hearing threshold was investigated. The quality of the fitted polynomial model was expressed by the coefficient of determination  $R^2$ , and its statistical significance was checked by the Fisher’s F-test in the same in-built statistical program of the Design Expert version 6.0.8. Model terms were evaluated by the  $p$  - value (probability) with 95% confidence level.

#### **3.4.4.1 Response surface method**

Response Surface Methodology (RSM) is one of the method that can give optimal situation in which the combination of age, years of exposure and noise level influence the hearing threshold. Mathematical models were developed and statistical analysis of the parameters interactions (age, years of exposure and noise level) on responses surface (hearing threshold) by RSM in MATLAB Statistical Software (Design Expert 6.0.8). Fitting and analysing response surfaces were done by the experimental design. Response Surface plot helps to visualize the possible interaction effect on the hearing threshold.

### **3.5 Selection of Values of Age, Years of Exposure and Noise Level for the Safe Hearing Threshold**

Design – Expert allows to set criteria for all variables, the software was used to set for the range of optimal combinations of age, years of exposure and noise level which can result to the safe hearing threshold values of 25-30 dB for the quarry workers. The ranges of safe hearing threshold were used as a “Goal” to construct desirability ( $d_i$ ). Desirability range from 0 to 1 for the hearing threshold at a particular frequency. The program combines each of the factors (age, years of exposure and noise level) desirability into a single number and then searches for the greatest overall desirability. A value of 1 represents the ideal case. 0 indicates that the hearing threshold fall outside desirable limits.

In setting the range, lower limit and upper limit was set in order to allow desirability equation works properly. By default, the range of values (25-30 dB) was set at the observed safe hearing threshold range.

Additional parameter called “Weights” was selected for safe hearing threshold at each frequency. Weights give added emphasis to upper or lower bounds value of safe hearing threshold at each frequency. With a weight of 1, desirability varies from 0 to 1 in linear fashion.

Weights greater than 1 (maximum weight is 10) give more emphasis to goals. Weights less than 1 (minimum weight is 0.1) give less emphasis to goals. Lower and upper weights at their default values of 1 and 1 respectively were entered in this work in order to ensure no bias.

“Importance” was used as a tool for changing relative priorities to achieve safe hearing threshold values of 25 – 30 dB for the optimisation of the combination of age, years of exposure and noise level. Out of 5 levels of importance produced by Design – Expert, ranging from 1 plus (+) to 5 plus (+ + + + +), this work used a medium setting of + + +. By leaving all importance criteria at their defaults, no goals were favored over others.

Running the optimisation is by clicking the solution tab; the defaults of the Ramps view occurred which give good visual on the best settings of age, years of exposure and noise level and the desirability of the predicted safe hearing threshold.

### **3.5.1 Determination of the combination of values of age, years of exposure and noise level that can result to the safe hearing threshold of workers**

This work also established the relationship between a particular present age of the worker to work or be working in the quarry, point of entry age of the worker into the quarry production job, optimal years of exposure to noisy production area in the quarry; and suitable workers' age in noisy production area in the quarry.

The relationship can be expressed as in equation (3.4) as follows:

$$(X - K) + Y \leq Z \quad (3.4)$$

Where,

$X$  - Present age of the worker to be worked or working in the quarry,

$K$  - Point of entry age of the workers into the quarry production job,

$Y$  - Optimal years of exposure to noisy production area in the quarry,

$Z$  - Suitable workers' age in noisy production area in the quarry.

### **3.6 Effects of age, years of exposure and noise level on hearing threshold over time**

In order to know what comes up by the combination of the factors considered (age, years of exposure and noise level) over the time, the two years experimental data were subjected to the following test:

- (i) Paired sample Pearson correlation coefficient of mean difference between hearing threshold in first and second year
- (ii) Paired sample statistics of the first and second year of mean hearing threshold of the respondents at all frequencies
- (iii) Paired sample t – test for differences in the hearing threshold in the first and second year.

### **3.7 Ergonomic Evaluation of Hearing Threshold Predictors**

The following hypothesis are accepted or rejected from the analysis of experiment conducted:

**H<sub>0</sub>**: Age of workers, years of exposure and noise level cannot significantly predict hearing threshold of workers.

**H<sub>1</sub>:** Age of workers, years of exposure and noise level significantly predict hearing threshold of the workers.

**Decision rule:** Accept H<sub>0</sub> if  $p\text{-value} > \alpha$  ( $=0.05$ ) or reject H<sub>0</sub> if  $p\text{-value} < 0.05$ .



## **CHAPTER FOUR**

### **RESULTS AND DISCUSSION**

#### **4.0 Chapter Overview**

This chapter presents and discusses the results of the analysis conducted on the workers in four Nigerian quarries (Q1, Q2, Q3 and Q4) to determine the synergistic interaction of Age, period of exposure and noise on hearing loss conducted at eight different hearing frequencies (0.25, 5.00, 1.00, 2.00, 3.00 4.00, 6.00 and 8.00 kHz). Essentially, the results presented and discussed include the,

- (i) general noise emission of the equipment used in quarry operation and general hearing threshold of workers
- (ii) ANFIS exhaustive search results for the factors that affect workers' hearing threshold at the various frequencies considered
- (iii) Hearing threshold predictive accuracies of the ANFIS models
- (iv) Hearing threshold predictive model equations of the quarry workers at various frequencies.
- (v) ANOVA outputs for determining significant hearing threshold factor interactions
- (vi) Effects of interacting factors on the hearing threshold of workers

The demographic distribution of the subjects showed that the age range of the workers was 15 to above 60 years. The modal age range was 31-45 years (51.50% in 2018 and 50.80% in 2019), while the age range with the least frequency was 60+ years (2.50% in 2018 and 50.80% in 2019). The sex distribution revealed that most of the quarry workers were mostly male (96.10% in 2018 and 96.70% in 2019). The academic qualifications of the respondents showed that the highest education attained by most of them was school certificate level. Tables 4.1 and 4.2 provide the demographic distribution details for the tests conducted in 2018 and 2019 respectively.

**Table 4.1: Distribution of Demographic Characteristics of Respondents in the Year 2018**

| <b>Demographic Factors</b>     |                    | <b>Frequency</b> | <b>Percentage</b> |
|--------------------------------|--------------------|------------------|-------------------|
| Gender                         | Male               | 196              | 96.1              |
|                                | Female             | 8                | 3.9               |
| Age                            | 15 – 30 years      | 19               | 9.3               |
|                                | 31 – 45 years      | 105              | 51.5              |
|                                | 46 – 60 years      | 75               | 36.8              |
|                                | 60+ years          | 05               | 2.5               |
|                                | Mean = 41.59       |                  |                   |
| Marital status                 | Single             | 11               | 5.4               |
|                                | Married            | 191              | 93.6              |
|                                | Divorced           | 2                | 1.0               |
| Highest Academic Qualification | School certificate | 89               | 43.6              |
|                                | Technical college  | 28               | 13.7              |
| Qualification                  | NCE/OND            | 58               | 28.4              |
|                                | B.Sc/HND           | 29               | 14.2              |
| Total                          |                    | 204              | 100               |

**Table 4.2: Distribution of Demographic Characteristics of Respondents in the Year 2019**

| <b>Demographic Factors</b>     |                    | <b>Frequency</b> | <b>Percentage</b> |
|--------------------------------|--------------------|------------------|-------------------|
| Gender                         | Male               | 179              | 96.7              |
|                                | Female             | 6                | 3.3               |
| Age                            | 15 – 30 years      | 18               | 9.7               |
|                                | 31 – 45 years      | 94               | 50.8              |
|                                | 46 – 60 years      | 71               | 38.4              |
|                                | 60+ years          | 02               | 1.1               |
|                                | Mean = 42.14       |                  |                   |
| Marital status                 | Single             | 11               | 5.6               |
|                                | Married            | 172              | 93.3              |
|                                | Divorced           | 2                | 1.0               |
| Highest Academic Qualification | School certificate | 78               | 42.2              |
|                                | Technical college  | 26               | 14.1              |
| Qualification                  | NCE/OND            | 54               | 29.2              |
|                                | B.Sc/HND           | 27               | 14.6              |
| Total                          |                    | 185              | 100               |

#### **4.1 Hearing Threshold of the Respondents within the Four Quarries**

As a precursor to utilizing the data collected in 2018 and 2019 from the respondents, a one way ANOVA test was conducted in order to ascertain if the respondents at all the four quarries were subjected to the same working conditions. The test of equality showed that the F values of variances for the 2018 and 2019 dataset equality for age, years of exposure, noise level and hearing threshold at frequency 250 Hz, 500 Hz, 1 kHz, 2 kHz, 3 kHz, 4 kHz, 6 kHz and 8 kHz were not significant at  $\alpha_{0.05}$ . This inferred that the datasets on hearing threshold in the year 2018 and 2019 came from the same population of quarry workers. Thus, the dataset obtained in the year 2018 or in the year 2019 experiment could be used collectively (Appendix G).

#### **4.2 General Noise levels and Hearing Threshold within Quarries**

##### **4.2.1 Noise Measurement at Various Facilities under Study**

The four understudied quarries consisted of different production units having more or less of the same types of machinery (Tables 4.3 and 4.4 display the noise levels obtained from the machine in the 4 quarries observed in the year 2018 and 2019). The noise measurement were in the range of 87.3 to 116.98 dBA in the production section, which implies that the noise levels produced exceeded the limiting threshold level of 85 dBA except in the administrative blocks where the noise level was less than the threshold of 85 dBA. It was observed that each of all four quarries produced an excessive amount of noise with the potential of being injurious to the hearing capabilities of workers.

**Table 4.3: Average noise levels (dBA) measured at workstations in the four quarries in 2018**

| <b>Type of Machine</b> | <b>Q1</b> | <b>Q2</b> | <b>Q3</b> | <b>Q4</b> |
|------------------------|-----------|-----------|-----------|-----------|
| Primary Crusher        | 115       | 112.3     | 114.3     | 114.5     |
| Secondary Crusher      | 116.9     | 112.3     | 114.9     | 112.2     |
| Compressor             | 113.5     | 108.3     | 113       | 101.7     |
| Dumper                 | 96        | 94.5      | 92.8      | 96.5      |
| Wagon Driller          | 94.4      | 91.1      | 92.3      | 98.1      |
| Pay Loader             | 93.1      | 91.5      | 92.8      | 93.3      |
| Drilling Machine       | 93.0      | 97.2      | 97.0      | 90.2      |
| Lathe                  | 88.3      | 87.3      | 88.0      | 88.2      |
| Excavator              | 97.3      | 93.2      | 97.0      | 95.4      |
| Administrative         | 39        | 28.4      | 53.3      | 59.7      |
| Mean                   | 100.83    | 98.63     | 100.23    | 98.90     |
| Standard Deviation     | ±0.36     | ±0.41     | ±1.01     | ±0.10     |

**Table 4.4: Average Noise Levels (dBA) Measured at Workstations in the Four Quarries in 2019**

| <b>Type of Machine</b> | <b>Q1</b> | <b>Q2</b> | <b>Q3</b> | <b>Q4</b> |
|------------------------|-----------|-----------|-----------|-----------|
| Primary Crusher        | 116       | 113       | 115       | 115.5     |
| Secondary Crusher      | 116.9     | 114       | 114       | 112       |
| Compressor             | 114       | 109       | 113       | 103       |
| Dumper                 | 98        | 95        | 93        | 97        |
| Wagon Driller          | 95        | 91        | 93        | 98.0      |
| Pay Loader             | 94.1      | 92        | 93.8      | 93        |
| Drilling Machine       | 94.5      | 98        | 97.5      | 91        |
| Lathe                  | 88        | 87.5      | 87.3      | 88        |
| Excavator              | 98        | 94        | 98.0      | 96        |
| Administrative         | 39        | 28.8      | 50        | 60        |
| Mean                   | 101.61    | 99.28     | 100.51    | 99.28     |
| Standard Deviation     | ±0.38     | ±0.51     | ±1.01     | ±0.10     |

#### **4.2.2 Hearing Threshold of respondents within the Quarries**

The hearing threshold among the workers in the quarries was  $45.60 \pm 1.24$  dBA from which 138 respondents (75%) had hearing thresholds higher than 25 dBA. Comparatively, the mean hearing threshold among workers at Q3 (47.92 dBA) > Q4 quarry (47.51 dBA) > Q2quarry (46.75 dBA) > Q1 (40.48 dBA) (Appendix I).

The one-way ANOVA test, (Appendix I) shows the differences between the mean values of hearing threshold level of the respondents of the four quarries as not significant ( $F = 1.068$ ,  $p = 0.364$ ). This indicates that the hearing threshold values of the workers operating in the four quarries under study are more or less the same. Thus, the respondents at all the quarries were subjected to about the same working conditions and environmental noise levels.

#### **4.3 ANFIS exhaustive search results for the factors that affect workers' hearing threshold at the various frequencies considered**

##### **(A) Response 1- Hearing Threshold at 250 Hz**

From the exhaustive search performed (Figure 4.1) to select the most significant factor on the worker's hearing threshold at 250 Hz, the training errors was much higher than the checking error, thus confirming many outliers and inconsistency with the data with much over fitting. It may be concluded that to obtain the most significant factor contributing to the hearing threshold at this frequency is not feasible; the reason for this may be related to low magnitude of the frequency involved. The influence of 3 categories of factors considered in this work cannot be determined.

##### **(B) Response 2 - Hearing Threshold at 500 Hz**

From the exhaustive search shown in Figure 4.2, the worker's age gave the least training error of 3.4141, thus significant on the hearing Threshold. Therefore, age is the highest contributing factor to the hearing threshold at this frequency.

##### **(C) Response 3 - Hearing Threshold at 1 kHz**

The exhaustive search shown in figure 4.3, the worker's age gave the least training error of 3.9118, thus significant on the hearing threshold.

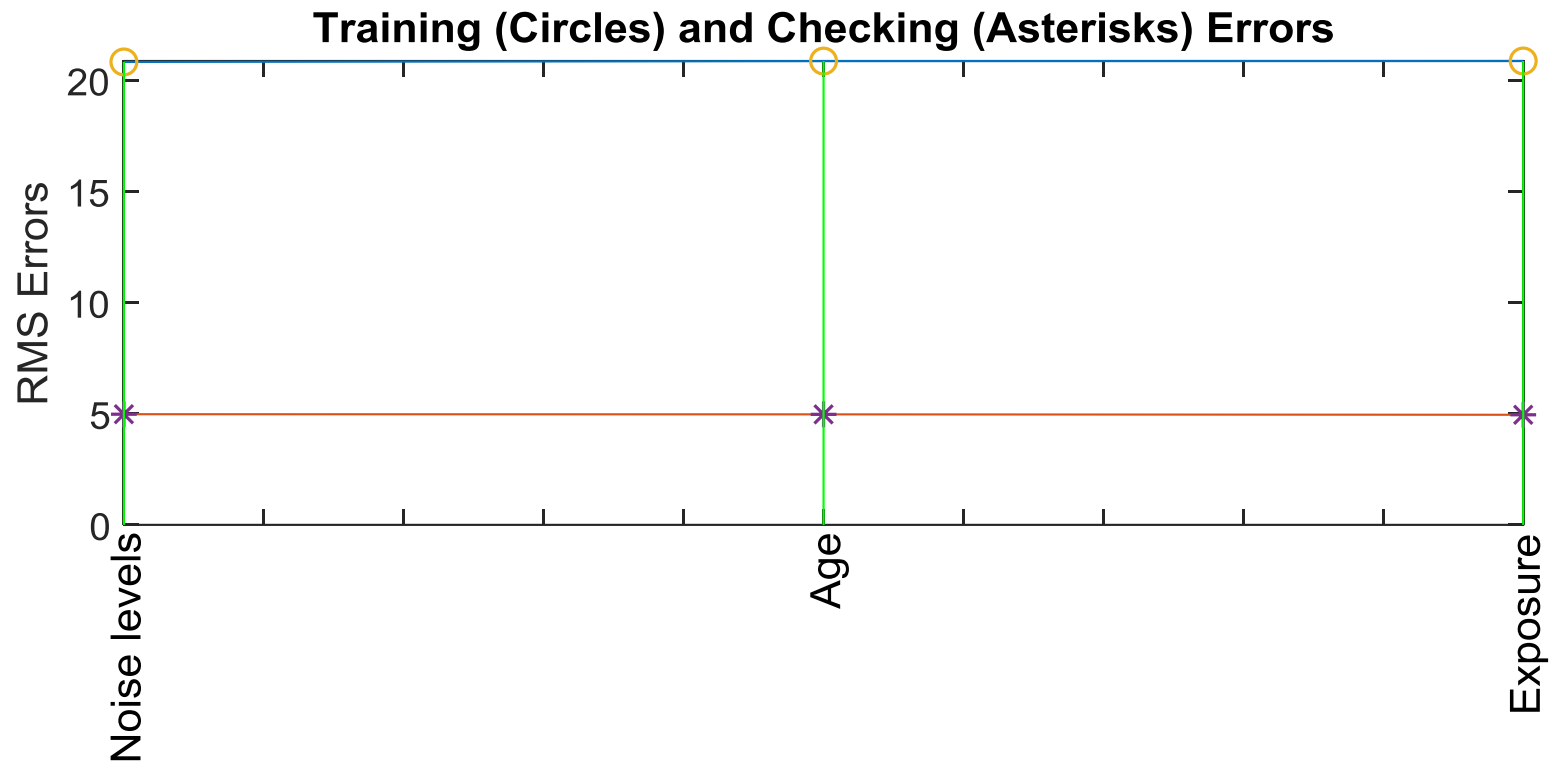
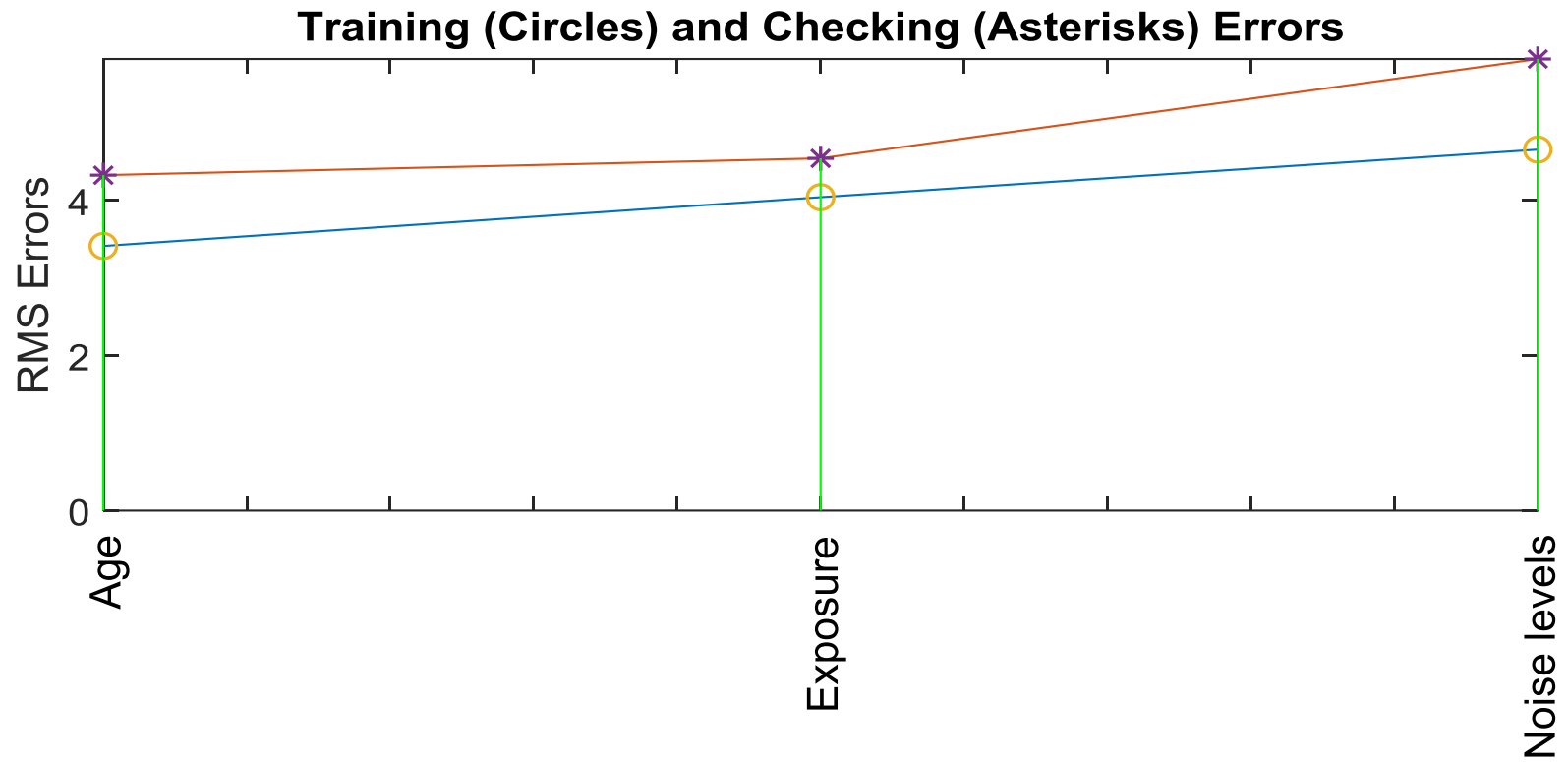


Figure 4.1: Exhaustive search for the operating parameters on hearing threshold at 250Hz





**Figure 4.2: Exhaustive search for the operating parameters on hearing threshold at 500 Hz**

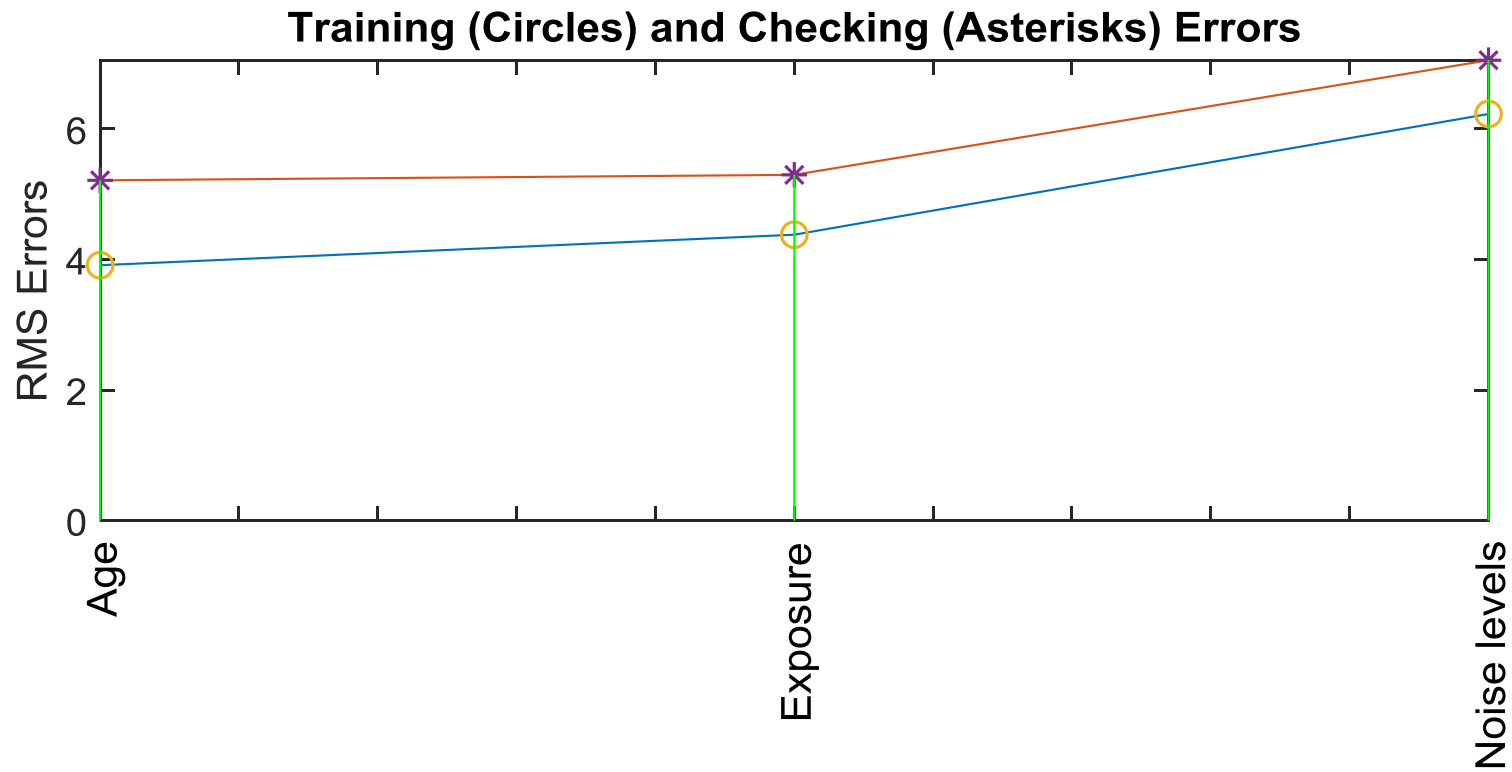


Figure 4.3: Exhaustive search for the operating parameters on hearing threshold at 1 kHz

**(D) Response 4 - Hearing Threshold at 2 kHz**

Exhaustive search in Figure 4.4 showed that the worker's age gave the least training error of 4.5750, thus significant on the hearing threshold.

**(E) Response 5 - Hearing Threshold at 3 kHz**

From the exhaustive search shown in Figure 4.5, the worker's age gave the least training error of 5.4766, thus significant on the hearing threshold.

**(F) Response 6 - Hearing Threshold at 4 kHz**

From the exhaustive search shown in Figure 4.6, the worker's age gave the least training error of 8.0740, thus significant on the hearing threshold.

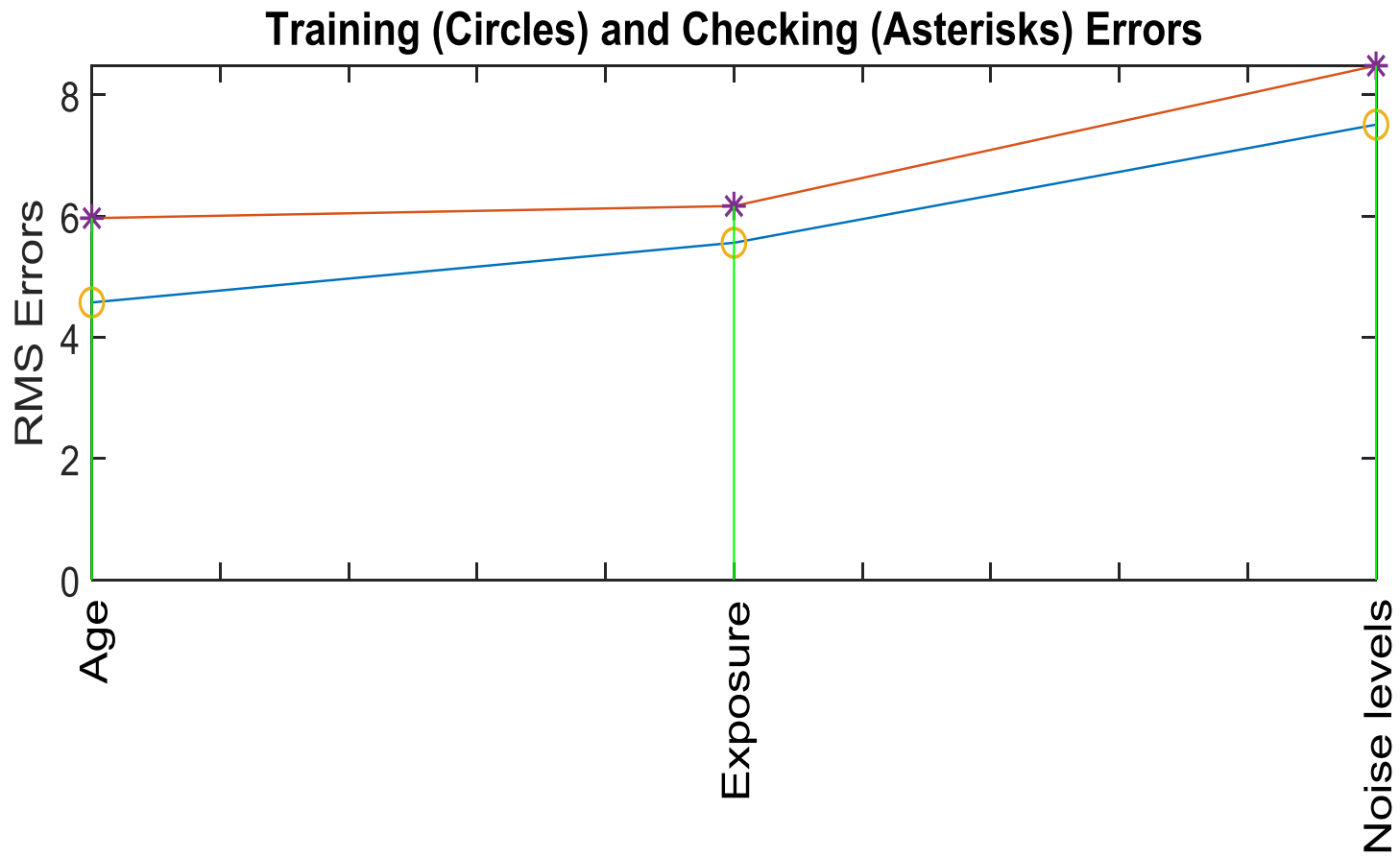
**(G) Response 7 - Hearing Threshold at 6 kHz**

From the exhaustive search shown in Figure 4.7, the worker's age gave the least training error of 6.8546, thus significant on the hearing threshold.

**(H) Response 8 - Hearing Threshold at 8 kHz**

From the exhaustive search shown in Figure 4.8, the worker's age gave the least training error of 7.0140, thus significant on the hearing threshold.

From the exhaustive search analysis of the three factors, it is clearly shown that quarry workers' age is the most contributing factor among the 3 factors (age, years of exposure and noise level) that influence the quarry workers hearing threshold with the range of 250 Hz and 8 kHz.



**Figure 4.4: Exhaustive search for the operating parameters on hearing threshold at 2 kHz**

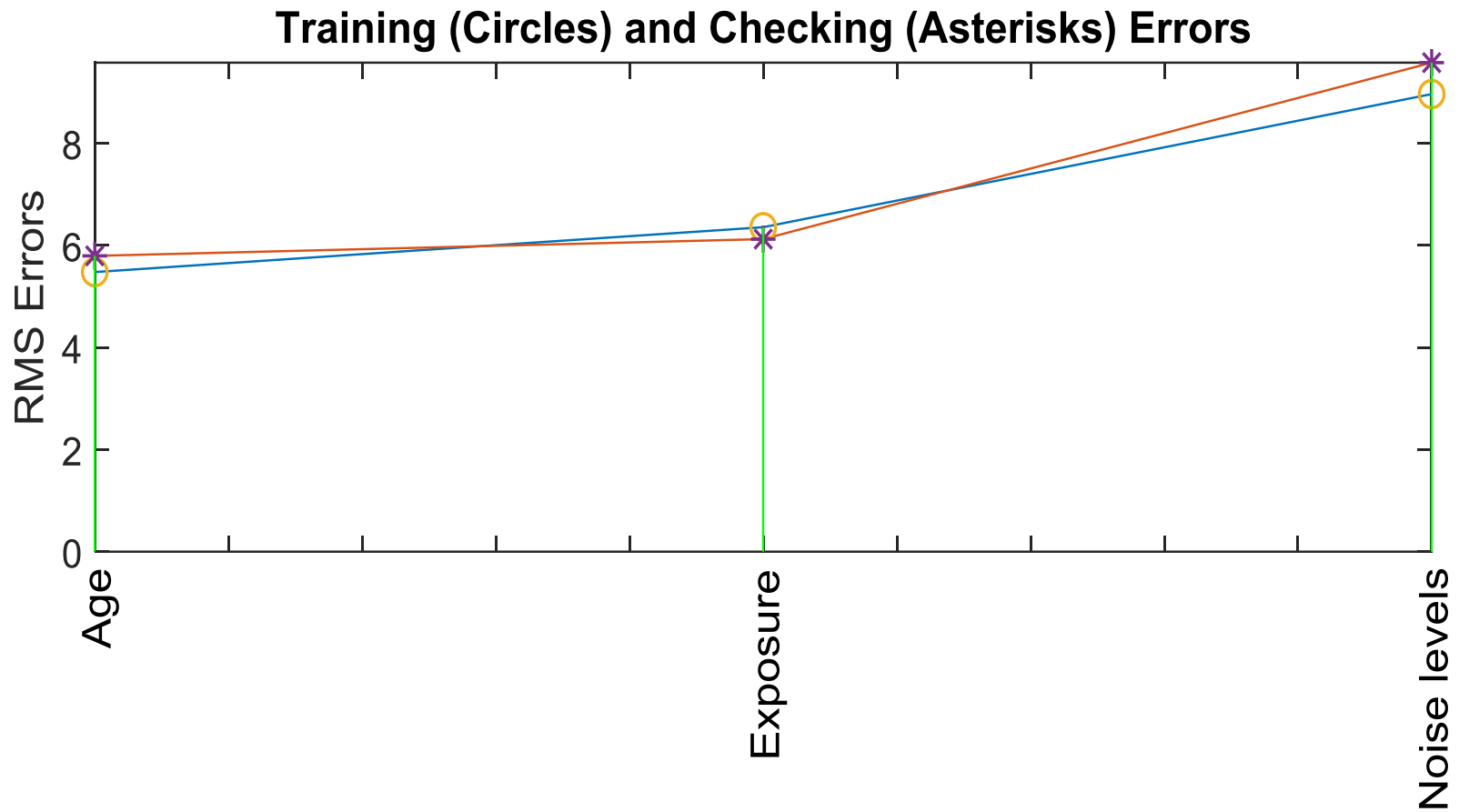


Figure 4.5: Exhaustive search for the operating parameters on hearing threshold at 3 kHz.

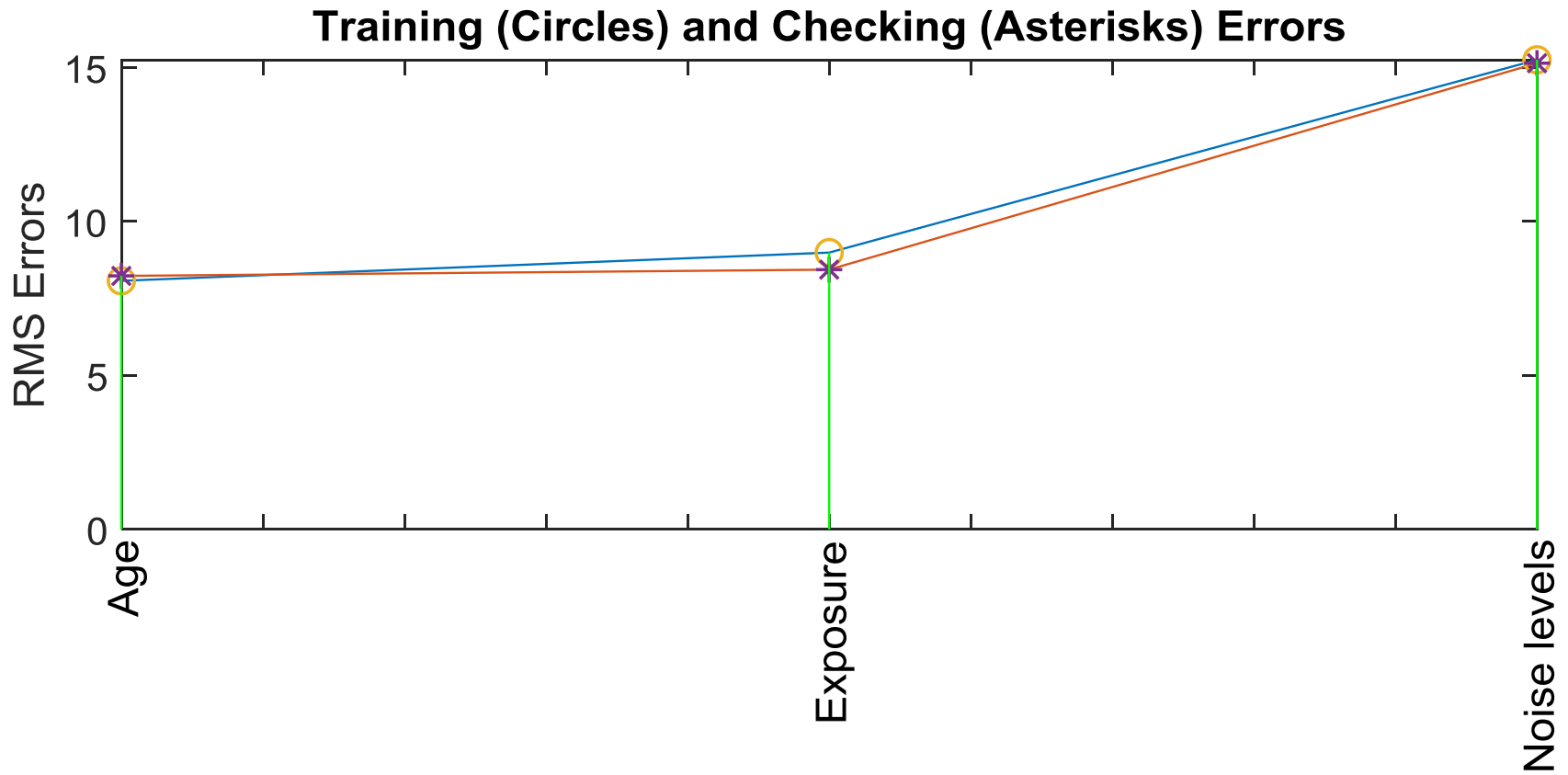


Figure 4.6: Exhaustive search for the operating parameters on hearing threshold at 4 kHz

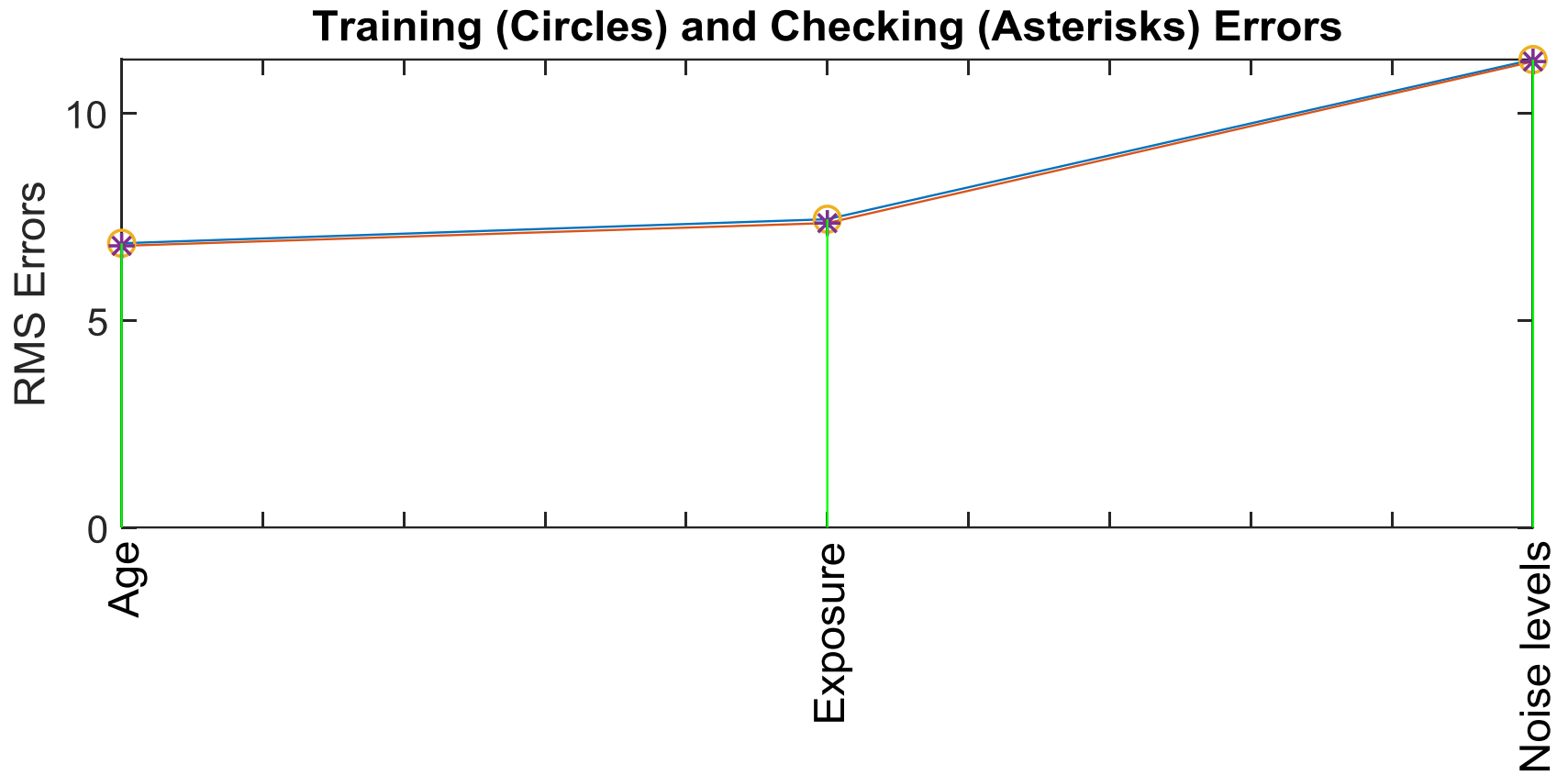


Figure 4.7: Exhaustive search for the operating parameters on hearing threshold at 6 kHz

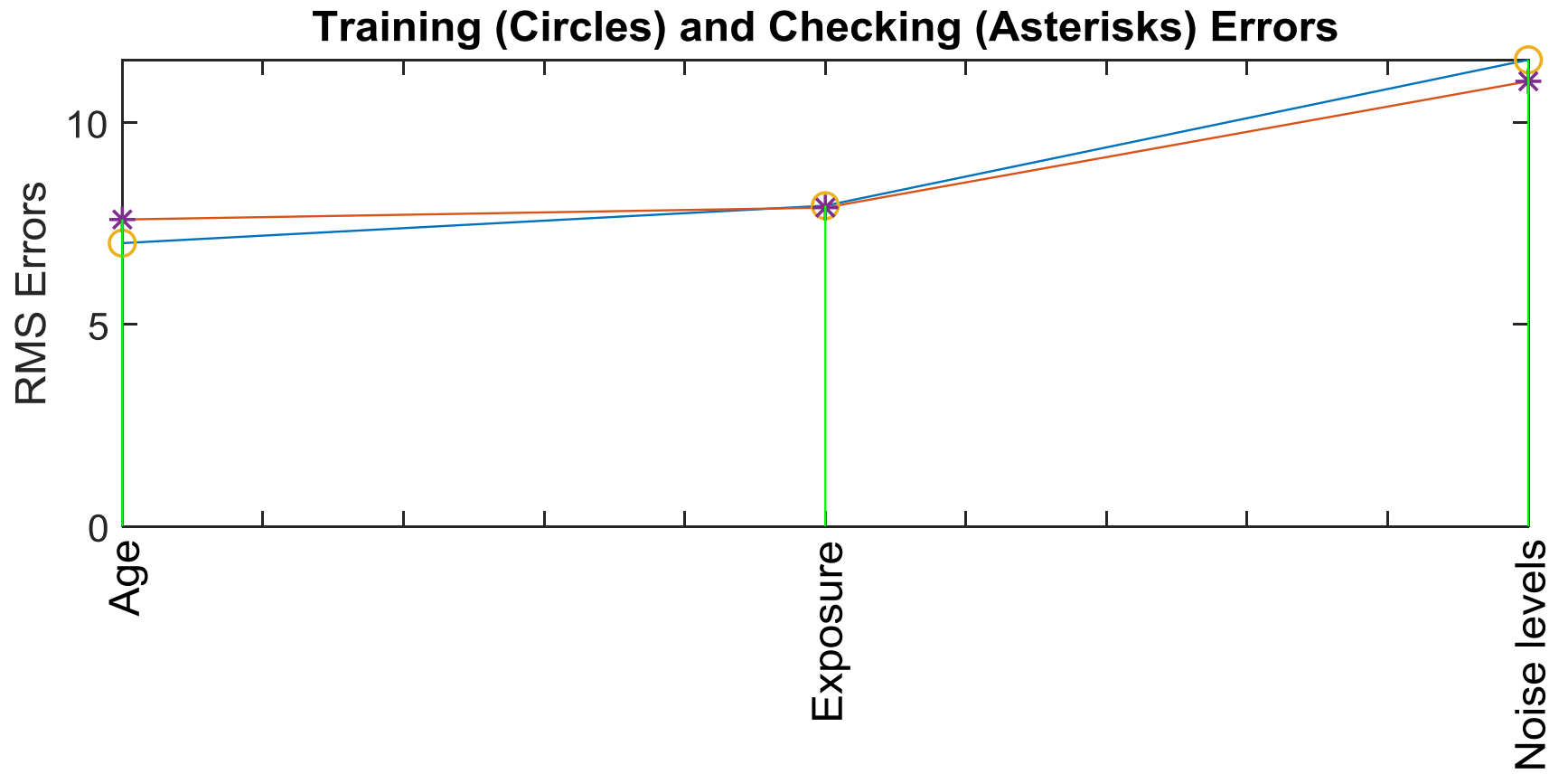


Figure 4.8: Exhaustive search for the operating parameters on hearing threshold at 8 kHz



#### **4.4 ANFIS Models Hearing Threshold Accuracies at Various Frequencies**

The exhaustive search model accuracies (in terms of RMSE and R-values) for the hearing threshold analysis conducted at the eight frequencies (500 Hz, 1 kHz, 2 kHz, 3 kHz, 4 kHz, 6 kHz and 8 kHz) considered in this study are here presented.

##### **(A) Hearing Threshold at 250 Hz**

Since it is not feasible to obtain the most significant factor that contribute to the hearing threshold at the frequency 250 Hz, hence Root Mean Square Error (RMSE) and R – values cannot be determined.

##### **(B) Hearing Threshold at 500 Hz**

From Table 4.5, the model estimation was performed using five input MF type (trimf, trapmf, gbellmf, gaussmf, gauss2mf). The best prediction and evaluation of the model occurred at input MF type gbell membership function which produced a low training error of 4.5202 and the checking error value of 5.7514, with the least positive difference between the training and checking RMSE (1.2312), and the highest correlation coefficient of 0.7610.

The plot of original data against predicted data for model estimation of the hearing threshold shows good prediction of the model (Figure 4.9). Both experimental data and predictive data follows the same trend as residuals (Figure 4.10), while the regression plot of experimental output and predicted output in Figure 4.11 also gives a correlation coefficient of 0.76103 which also indicates good prediction for the hearing threshold at 500 Hz.

##### **(C) Hearing Threshold at 1 kHz**

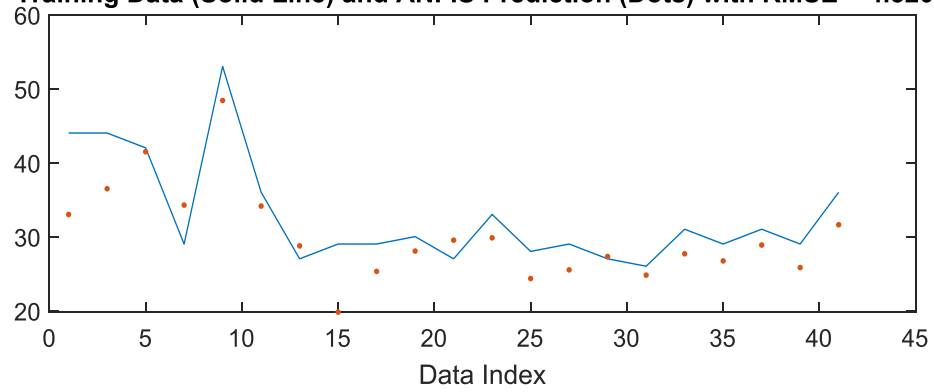
The best prediction and evaluation of the model occurred at input MF type trimf membership function which gave low training error of 4.5872 and the checking error value of 6.7494, with the least positive difference between the training and checking RMSE 2.1622, with the highest correlation coefficient of 0.7991 (Table 4.6). The plot of original data against predicted data for model estimation of the hearing threshold shows good prediction of the model (Figure 4.12).

**Table 4.5: RMSE and R- values for hearing threshold at 500 Hz**

| <b>Input MF type</b> | <b>RMSE</b>     |                 | <b>Correlation coefficient (R-value)</b> |
|----------------------|-----------------|-----------------|--|
|                      | <b>Training</b> | <b>Checking</b> |  |
| Trimf                | 4.6159          | 6.5547          | 0.7578                                   |
| Trapmf               | 5.6696          | 7.3474          | 0.6961                                   |
| Gbellmf              | 4.5202          | 5.7514          | 0.7610                                   |
| Gaussmf              | 5.0171          | 6.6484          | 0.7443                                   |
| gauss2mf             | 5.3549          | 7.0046          | 0.7216                                   |

MF number: 2, Epoch number = 100, Output MF type: Constant

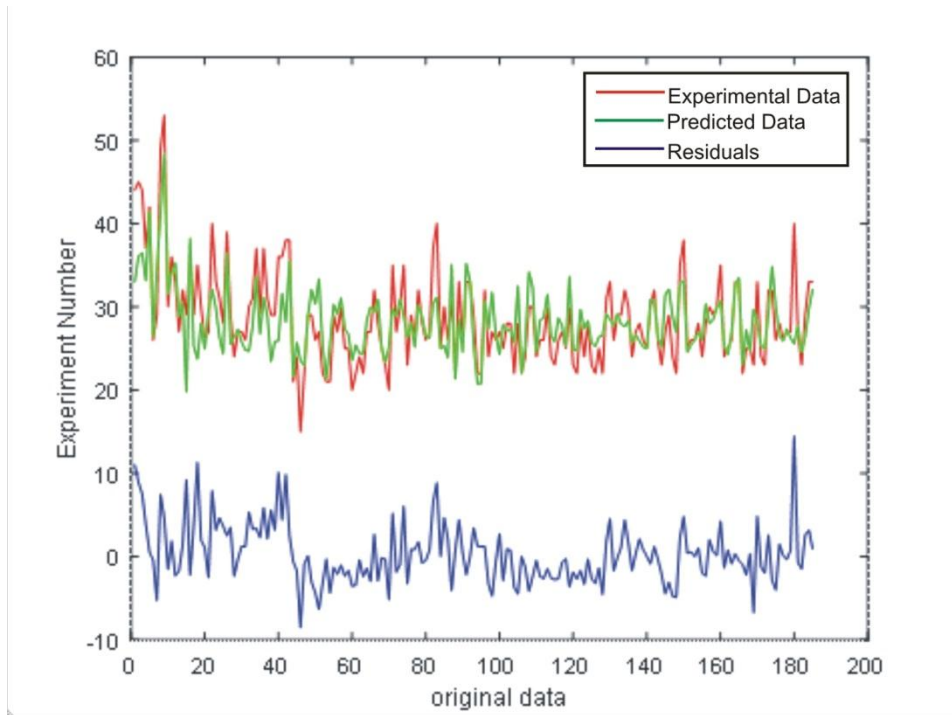
**Training Data (Solid Line) and ANFIS Prediction (Dots) with RMSE = 4.5202**



**Checking Data (Solid Line) and ANFIS Prediction (Dots) with RMSE = 5.7514**



**Figure 4.9: Plot of original data against predicted data for model estimation of the hearing threshold at 500 Hz**



**Figure 4.10: Plot of predicted output with residuals for the hearing threshold at 500Hz**



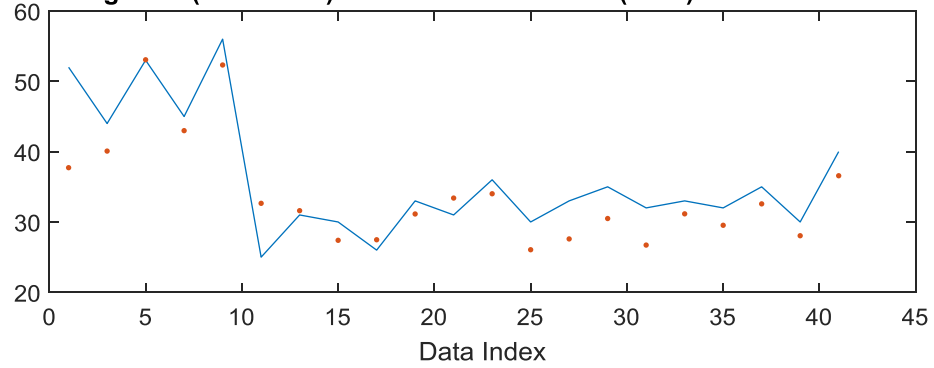
**Figure 4.11: Regression plot of experimental and predicted output for the hearing threshold at 500 Hz**

**Table 4.6: RMSE and R-values for hearing threshold at 1 kHz**

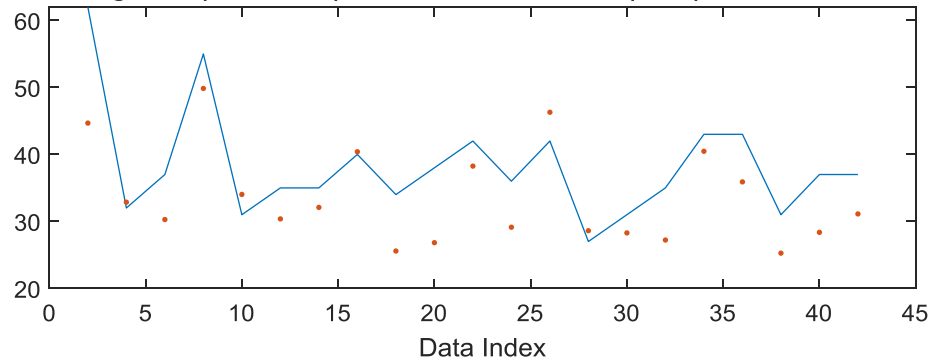
| <b>Input MF type</b> | <b>RMSE</b>     |                 | <b>Correlation coefficient (R-value)</b> |
|----------------------|-----------------|-----------------|--|
|                      | <b>Training</b> | <b>Checking</b> |  |
| trimf                | 4.5872          | 6.7494          | 0.7991                                   |
| trapmf               | 5.0812          | 7.6363          | 0.7606                                   |
| gbellmf              | 4.3729          | 6.9998          | 0.7949                                   |
| gaussmf              | 4.5322          | 6.8266          | 0.7952                                   |
| gauss2mf             | 4.5933          | 7.2922          | 0.7780                                   |

MF number: 2, Epoch number = 100, Output MF type: Constant

**Training Data (Solid Line) and ANFIS Prediction (Dots) with RMSE = 4.5872**



**Checking Data (Solid Line) and ANFIS Prediction (Dots) with RMSE = 6.7494**



**Figure 4.12: Plot of original data against predicted data for model estimation of the hearing threshold at 1 kHz**

Both experimental data and predictive data follows the same trend as residuals (Figure 4.13), while the regression plot of experimental output and predicted output in Figure 4.14 also gives good correlation coefficient of 0.79909 which also indicates good prediction of the hearing threshold at this frequency.

#### **(D) Hearing Threshold at 2 kHz**

Input MF type gbell membership function gives the best prediction and evaluation of the model at frequency 2kHz with low training error of 4.6731 and the checking error value of 6.5173, resulted in a positive difference between the training error and checking RMSE of 1.8442 (Table 4.7). The plot of original data against predicted data for model estimation of the hearing threshold shows good prediction of the model (Figure 4.15). Both experimental data and predictive data follow the same trend as residuals (Figure 4.16). Correlation coefficient value of 0.82381 in the regression plot of experimental output and predicted output in Figure 4.17 also indicates good model prediction for the hearing threshold at this frequency.

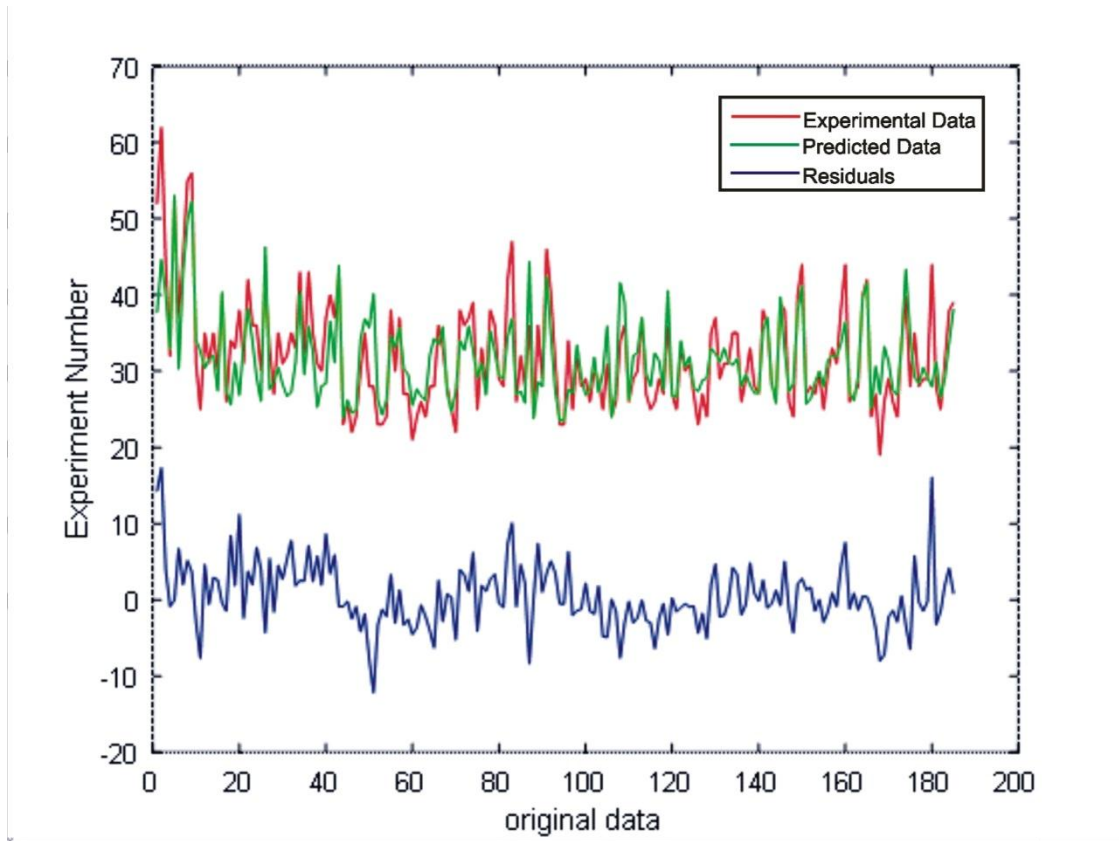
#### **(E) Hearing Threshold at 3 kHz**

MF type gbell membership function gives low training error of 5.9462, checking error value of 5.0187, least positive difference between training and checking RMSE value of 0.9275 with the highest correlation coefficient of 0.8329 (Table 4.8). The plot of original data versus predicted data for the model estimation of the hearing threshold depicts good model prediction (Figure 4.18). Figure 4.19 shows the good prediction accuracy with the good relationship between the plot of experimental data, prediction data and residuals. Correlation coefficient value of 0.83293 in the regression plot of experimental output and predicted output in figure 4.20 also established good model prediction at this frequency.

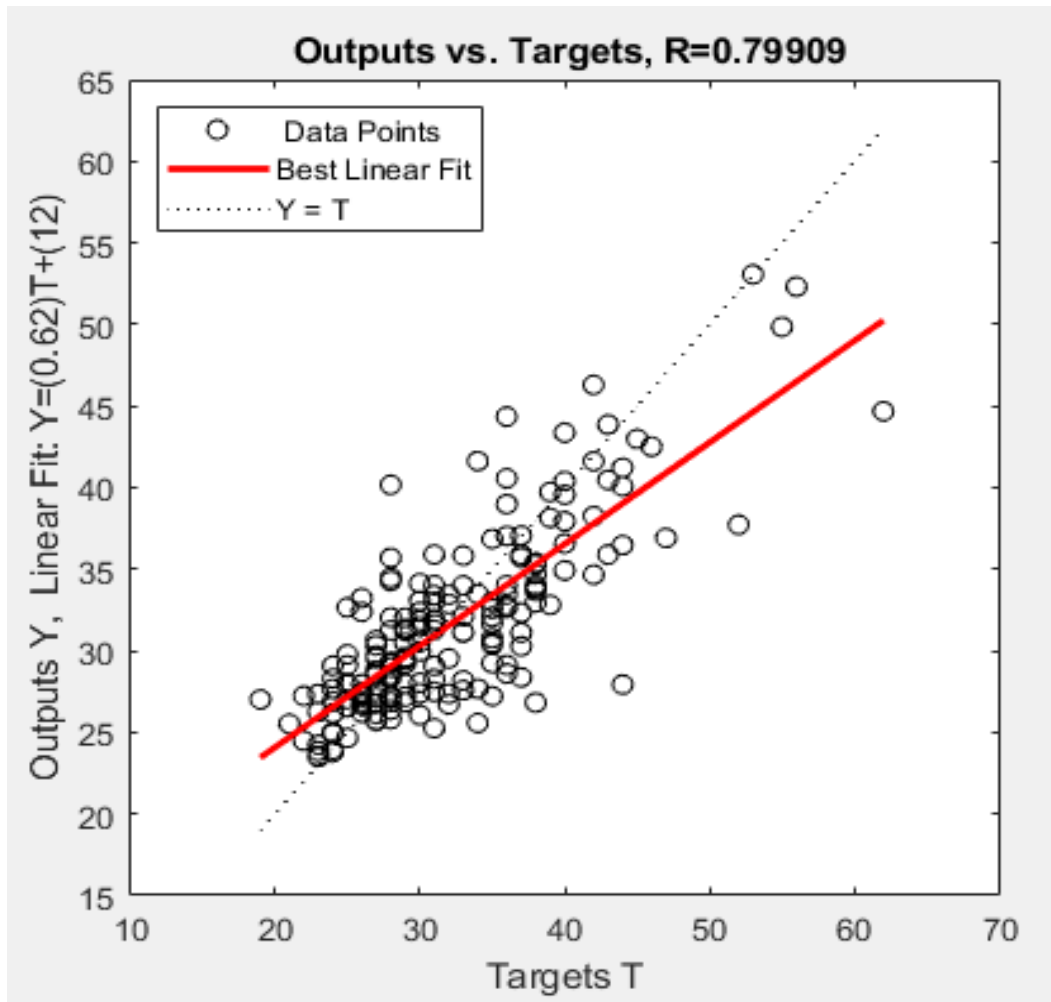
#### **(F) Hearing Threshold at 4 kHz**

The best prediction and evaluation of the model occurred at input MF type gbell membership function which gave low training error of 8.9601 and the checking error value of 9.3694, with the least positive difference between the training and checking RMSE (0.4093), and the highest correlation coefficient of 0.8678 (Table 4.9).





**Figure 4.13: Plot of predicted output with residuals for the hearing threshold at 1 kHz**



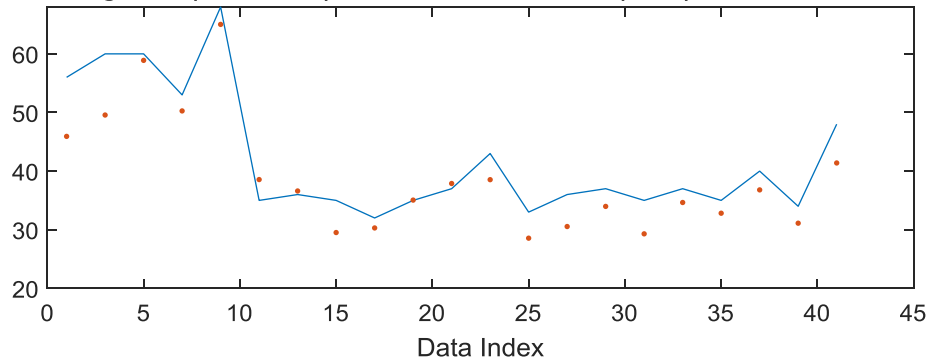
**Figure 4.14: Regression plot of experimental and predicted output for the hearing threshold at 1 kHz**

**Table 4.7: RMSE and R-values for hearing threshold at 2 kHz**

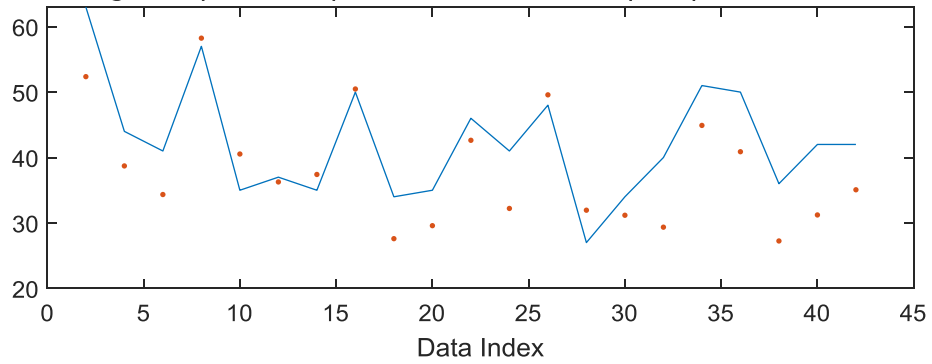
| <b>Input MF type</b> | <b>RMSE</b>     |                 | <b>Correlation coefficient (R-value)</b> |
|----------------------|-----------------|-----------------|--|
|                      | <b>Training</b> | <b>Checking</b> |  |
| Trimf                | 5.1839          | 7.1771          | 0.8198                                   |
| Trapmf               | 5.65            | 7.8937          | 0.7946                                   |
| Gbellmf              | 4.6731          | 6.5173          | 0.8238                                   |
| Gaussmf              | 5.0427          | 7.1369          | 0.8190                                   |
| gauss2mf             | 5.1356          | 7.6100          | 0.8079                                   |

MF number: 2, Epoch number = 100, Output MF type: Constant

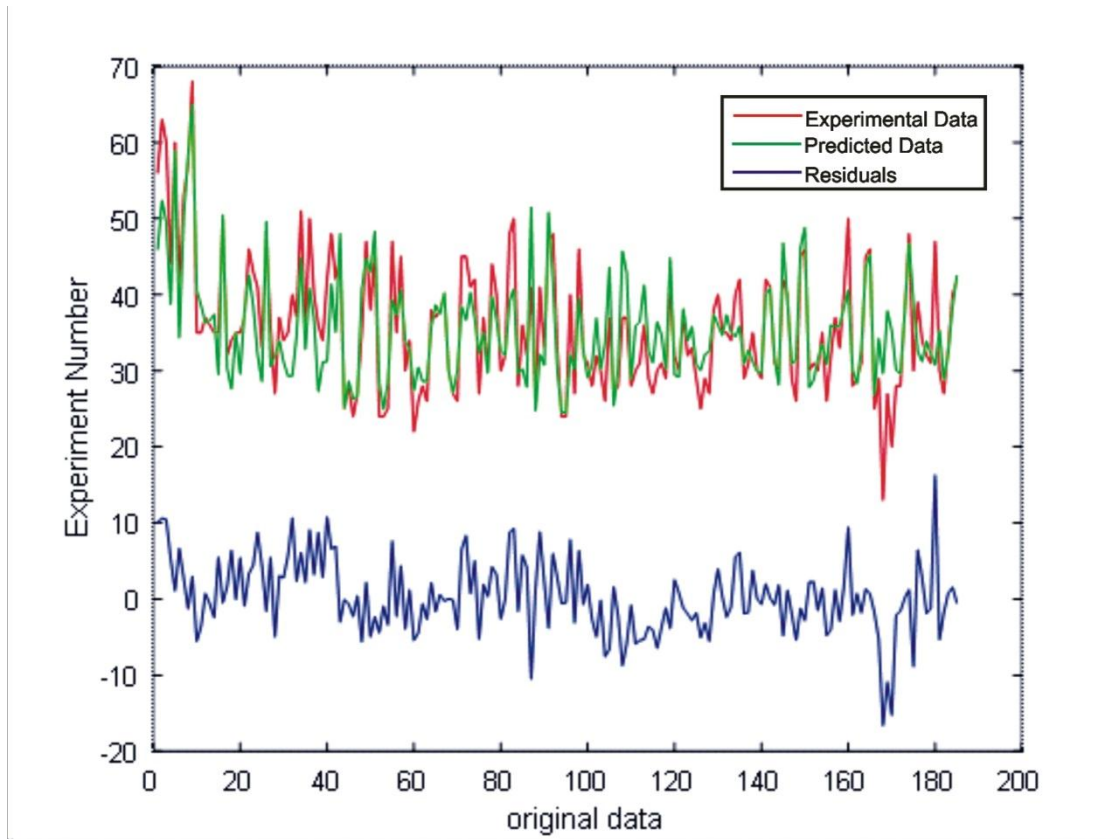
**Training Data (Solid Line) and ANFIS Prediction (Dots) with RMSE = 4.6731**



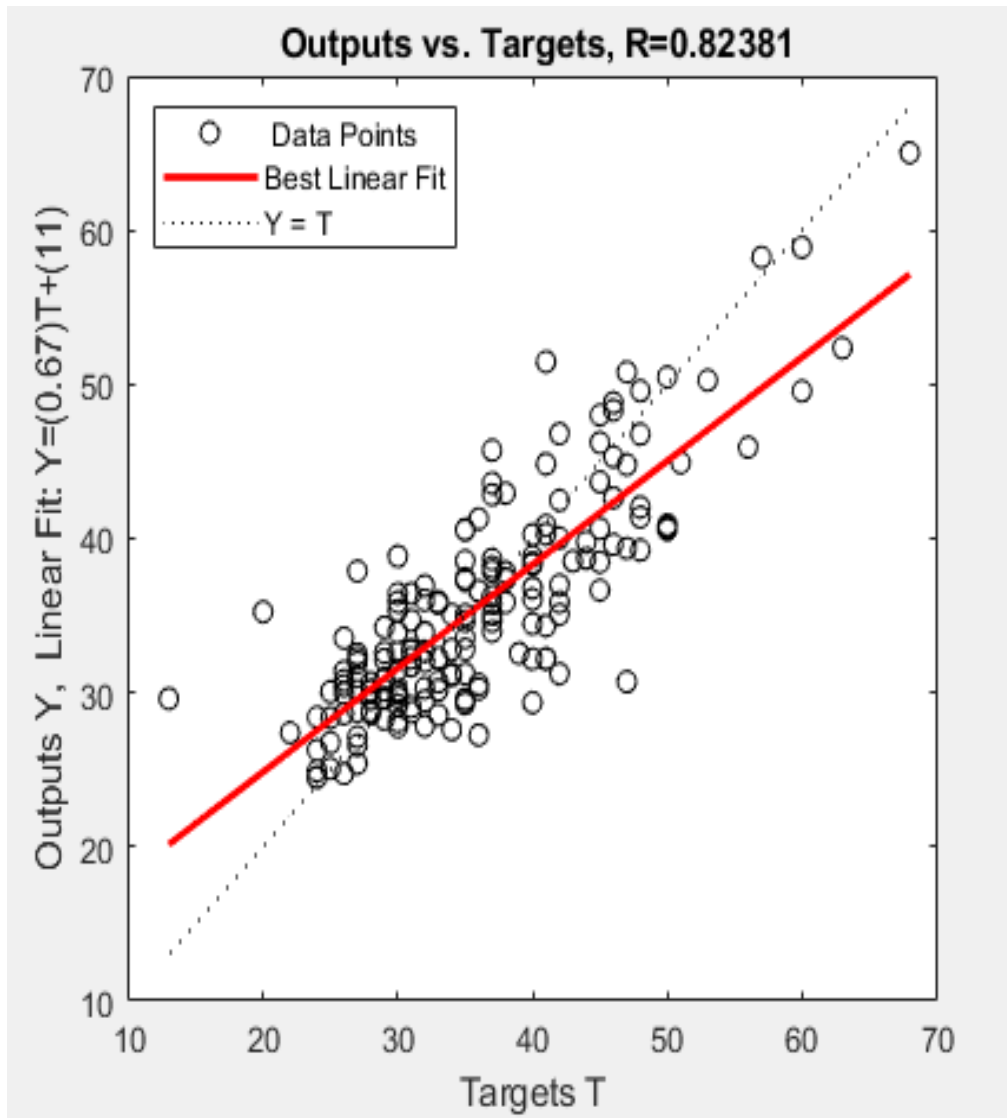
**Checking Data (Solid Line) and ANFIS Prediction (Dots) with RMSE = 6.5173**



**Figure 4.15: Plot of original data against predicted data for model estimation of the hearing threshold at 2 kHz**



**Figure 4.16: Plot of predicted output with residuals for the hearing threshold at 2 kHz**



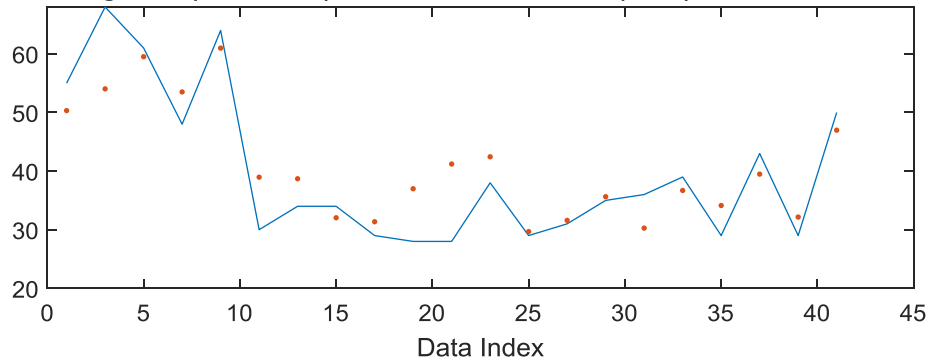
**Figure 4.17: Regression plot of experimental and predicted output for the hearing threshold at 2 kHz**

**Table 4.8: RMSE and R-values for hearing threshold at 3 kHz**

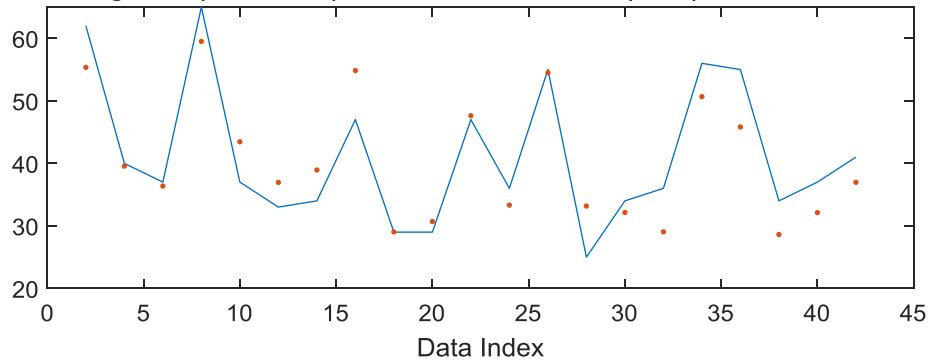
| Input MF type | RMSE     |          | Correlation coefficient (R-value) |
|---------------|----------|----------|-----------------------------------|
|               | Training | Checking |                                   |
| trimf         | 6.8562   | 5.3466   | 0.8170                            |
| trapmf        | 5.4153   | 6.9070   | 0.8209                            |
| gbellmf       | 5.9462   | 5.0187   | 0.8329                            |
| gaussmf       | 6.5821   | 5.2026   | 0.8264                            |
| gauss2mf      | 6.0383   | 7.1341   | 0.8269                            |

MF number: 2, Epoch number = 100, Output MF type: Constant

**Training Data (Solid Line) and ANFIS Prediction (Dots) with RMSE = 5.9462**

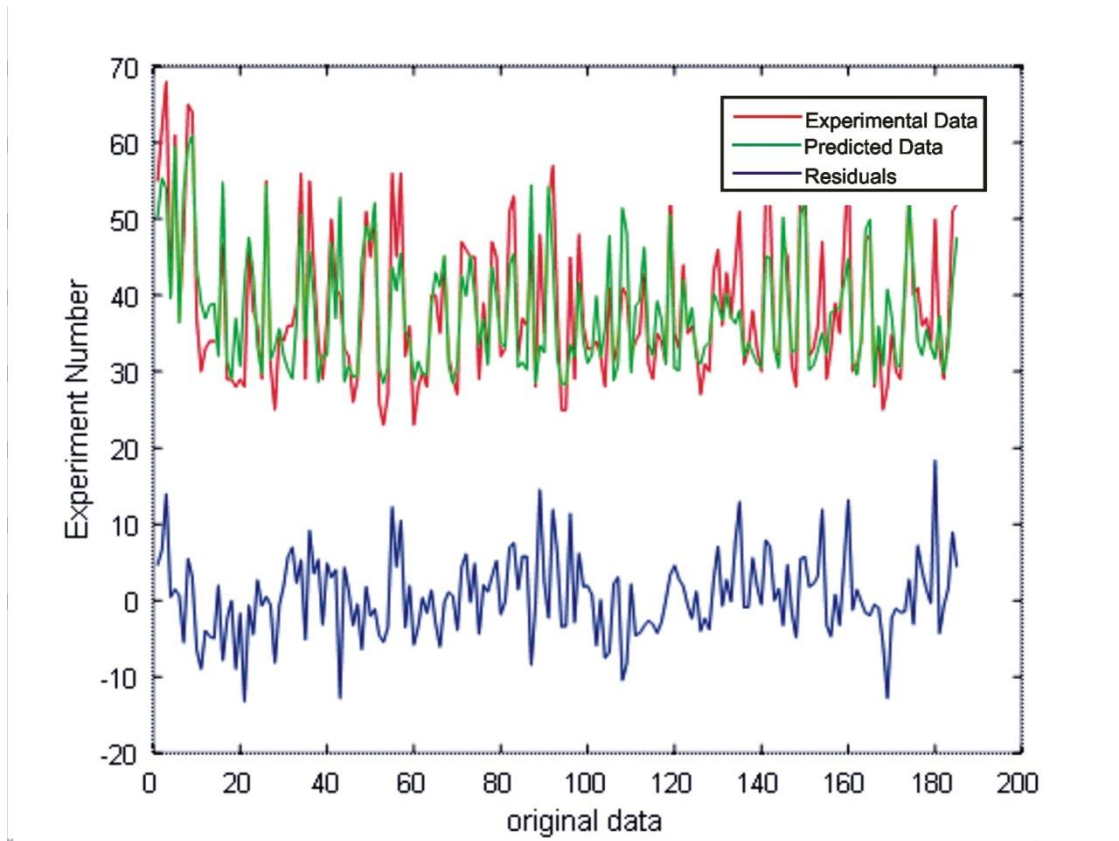


**Checking Data (Solid Line) and ANFIS Prediction (Dots) with RMSE = 5.0187**



**Figure 4.18: Plot of original data against predicted data for model estimation of the hearing threshold at 3 kHz**





**Figure 4.19: Plot of predicted output with residuals for the hearing threshold at 3 kHz**

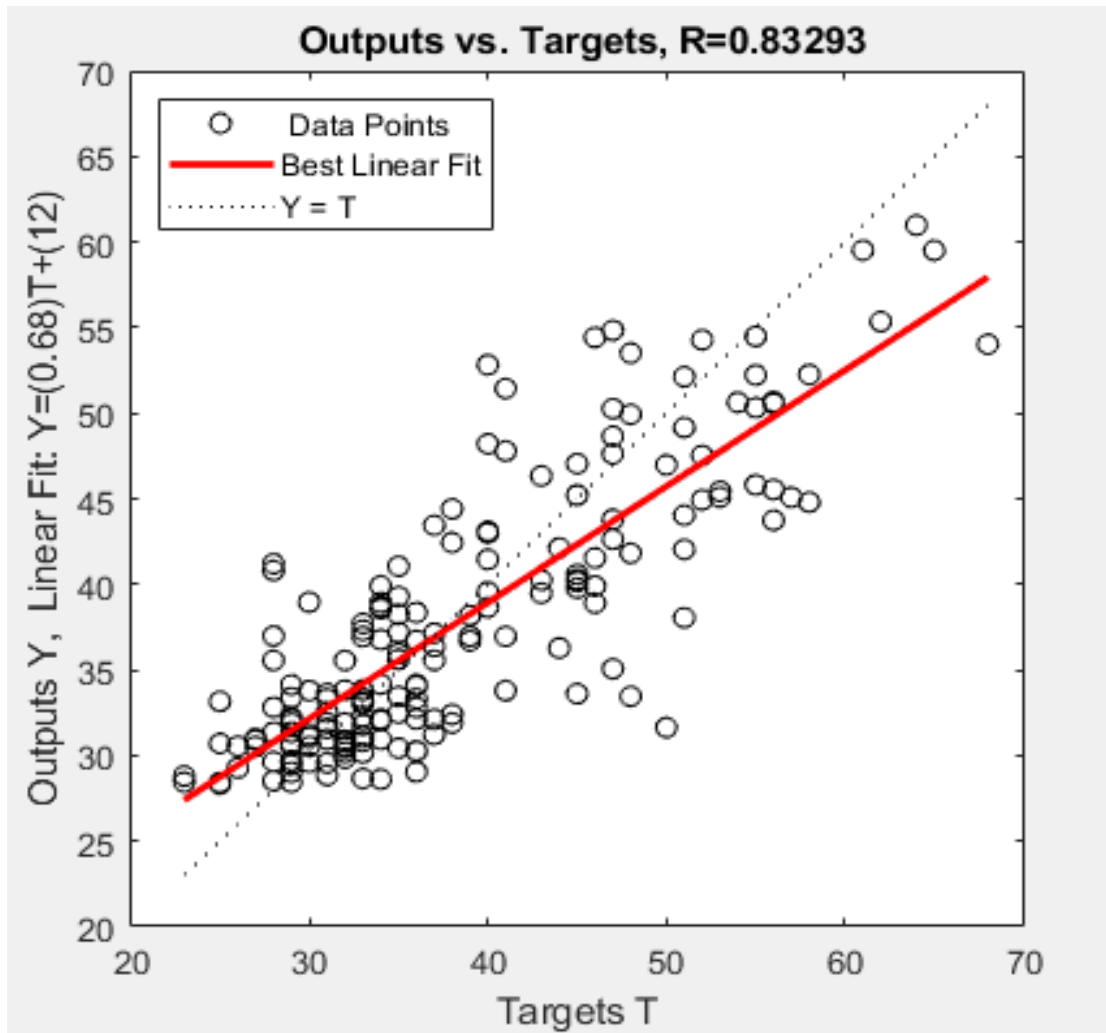


Figure 4.20: Regression plot of experimental and predicted output for the hearing threshold at 3 kHz

**Table 4.9: RMSE and R-values for hearing threshold at 4 kHz**

| Input MF type | RMSE     |          | Correlation coefficient (R-value) |
|---------------|----------|----------|-----------------------------------|
|               | Training | Checking |                                   |
| Trimf         | 9.5564   | 10.0758  | 0.8572                            |
| Trapmf        | 9.114    | 10.0037  | 0.8565                            |
| Gbellmf       | 8.9601   | 9.3694   | 0.8678                            |
| Gaussmf       | 9.5896   | 10.1394  | 0.8612                            |
| gauss2mf      | 9.006    | 10.2047  | 0.8633                            |

MF number: 2, Epoch number = 100, Output MF type: Constant

The plot of original data versus predicted data for the model estimation of the hearing threshold depicts good model prediction (Figure 4.21). Both experimental data and predictive data follows the same trend (Figure 4.22), with residuals. The regression plot of experimental output and predicted output in Figure 4.23, also gives good correlation coefficient of 0.86784 which indicates good prediction of hearing threshold at this frequency.

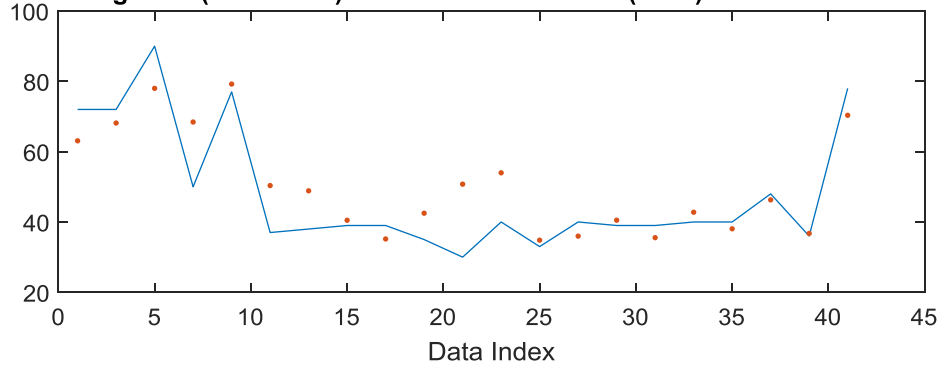
#### **(G)Hearing Threshold at 6 kHz**

The best prediction and evaluation of the model occurred at input MF type gbell membership function which gave low training error of 8.2480 and the checking error value of 7.139, with the least positive difference between the training and checking RMSE (1.109), and the highest correlation coefficient of 0.8165 (Table 4.10). Original data versus predicted data plot for the model estimation of the hearing threshold depicts good model prediction (Figure 4.24). Both experimental data and predictive data follow the same trend (Figure 4.25) with the residuals plot. The Regression plot of experimental output and predicted output in Figure 4.26 also gives good correlation coefficient of 0.81648 which indicates good prediction of hearing threshold at the frequency 6 kHz.

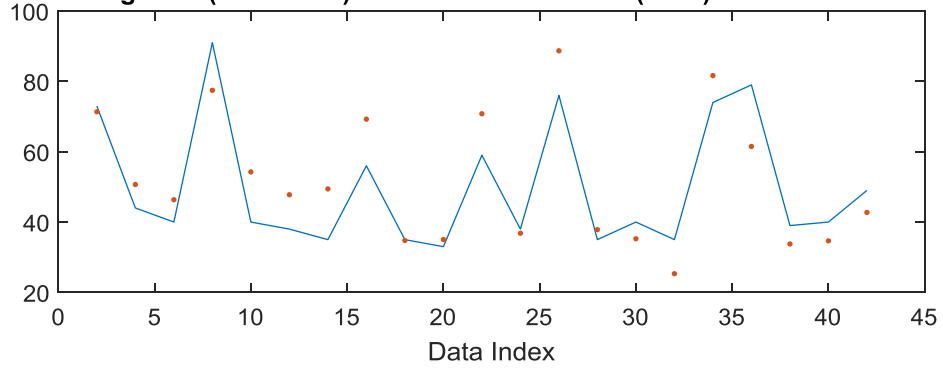
#### **(H) Hearing Threshold at 8 kHz**

Five input MF type (trimf, trapmf, gbellmf, gaussmf, gauss2mf) was used for the model estimation. Input MF type gbell membership function gives low training error of 9.0428 and the checking error of 7.9062, having least positive difference between the training and checking RMSE value of 1.1366 and highest correlation coefficient of 0.7980 (Table 4.11). Hence input MF type gbell membership produced the best model prediction and evaluation at this frequency. The plot of original data against the predicted data for the model estimation depicts good prediction for the hearing threshold (Figure 4.27). Both experimental data and predictive data follow the same trend (Figure 4.28) with the residuals plot. The Regression plot of experimental output and predicted output in Figure 4.29 also gives good correlation coefficient of 0.79802 which indicates good prediction of hearing threshold at 8 kHz.

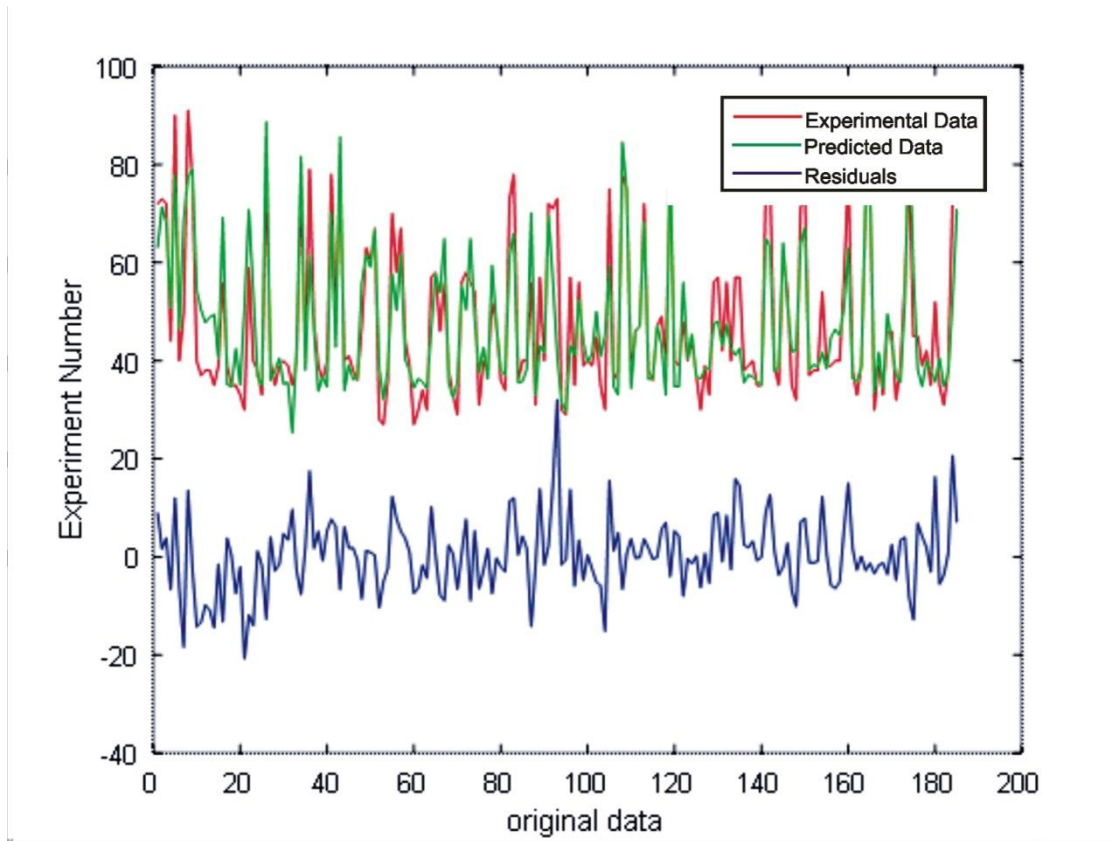
**Training Data (Solid Line) and ANFIS Prediction (Dots) with RMSE = 8.9601**



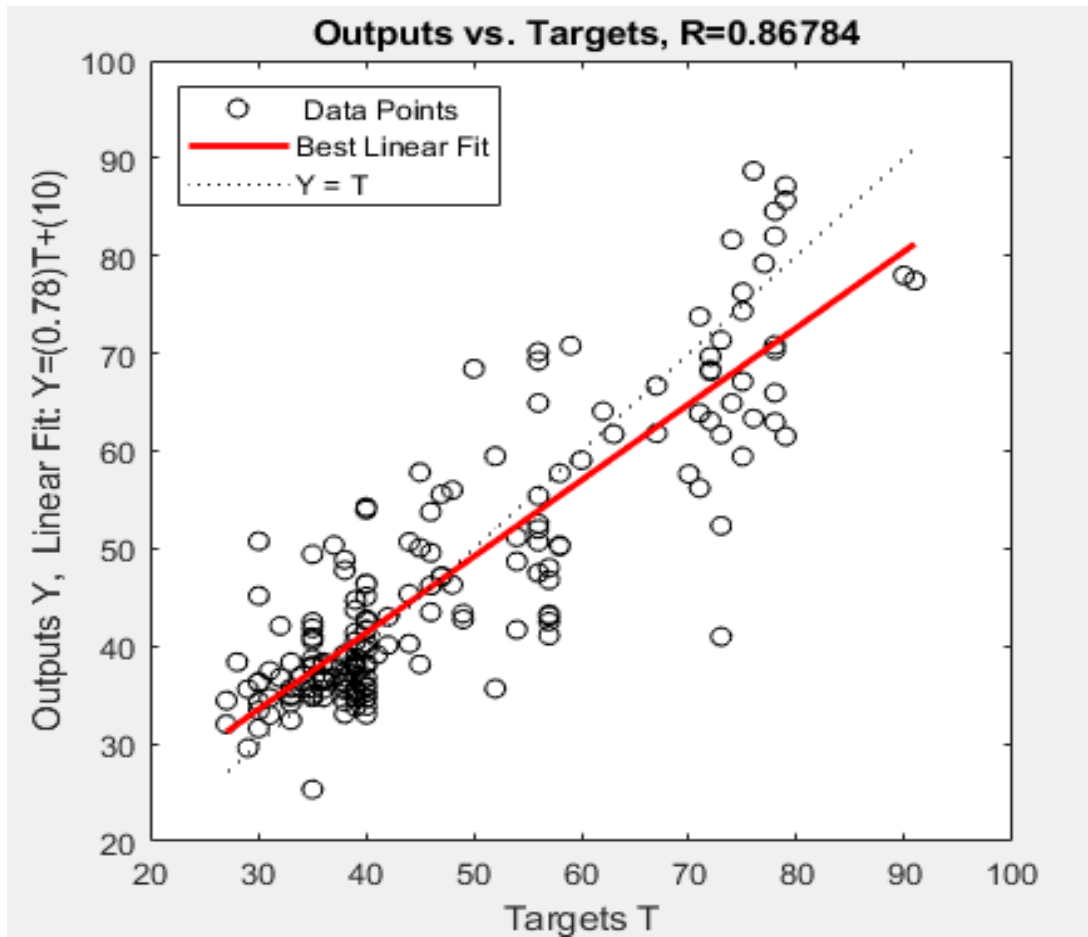
**Checking Data (Solid Line) and ANFIS Prediction (Dots) with RMSE = 9.3694**



**Figure 4.21: Plot of original data against predicted data for model estimation of the hearing threshold at 4 kHz**



**Figure 4.22: Plot of predicted output with residuals for the hearing threshold at 4 kHz**



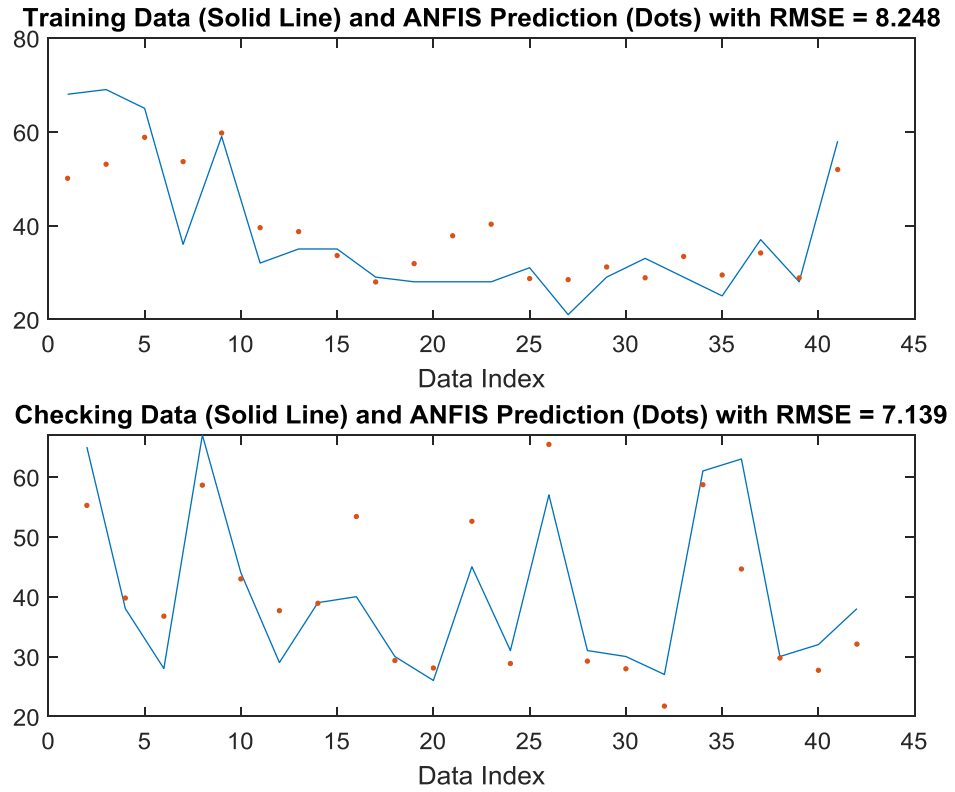
**Figure 4.23: Regression plot of experimental and predicted output for the hearing threshold at 4 kHz**

**Table 4.10: RMSE and R-values for the hearing threshold at 6 kHz**

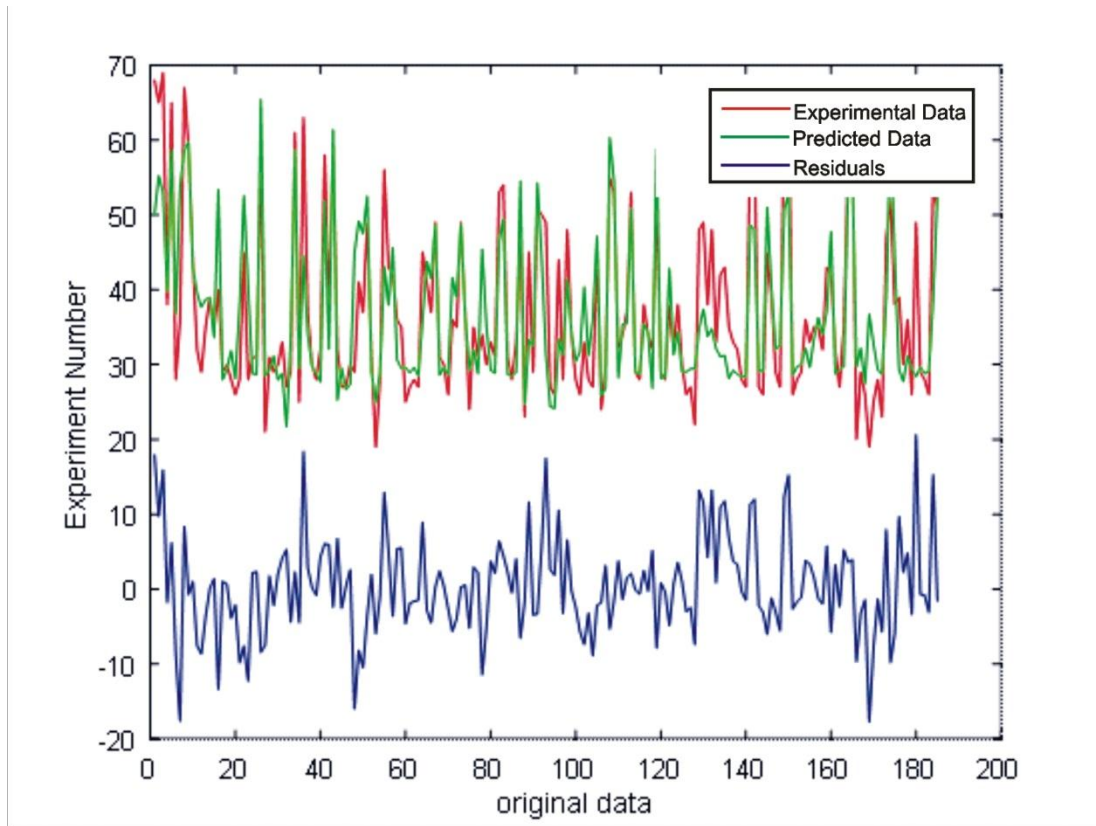
| Input MF type | RMSE     |          | Correlation coefficient (R-value) |
|---------------|----------|----------|-----------------------------------|
|               | Training | Checking |                                   |
| Trimf         | 9.0412   | 7.5325   | 0.8036                            |
| Trapmf        | 8.9753   | 7.4627   | 0.8057                            |
| Gbellmf       | 8.2480   | 7.1390   | 0.8165                            |
| Gaussmf       | 8.7344   | 7.2566   | 0.8109                            |
| gauss2mf      | 8.8482   | 7.5775   | 0.8145                            |

MF number: 2, Epoch number = 100, Output MF type: Constant





**Figure 4.24: Plot of original data against predicted data for model estimation of the hearing threshold at 6 kHz**



**Figure 4.25: Plot of Predicted Output with Residuals for the Hearing Threshold at 6 kHz**

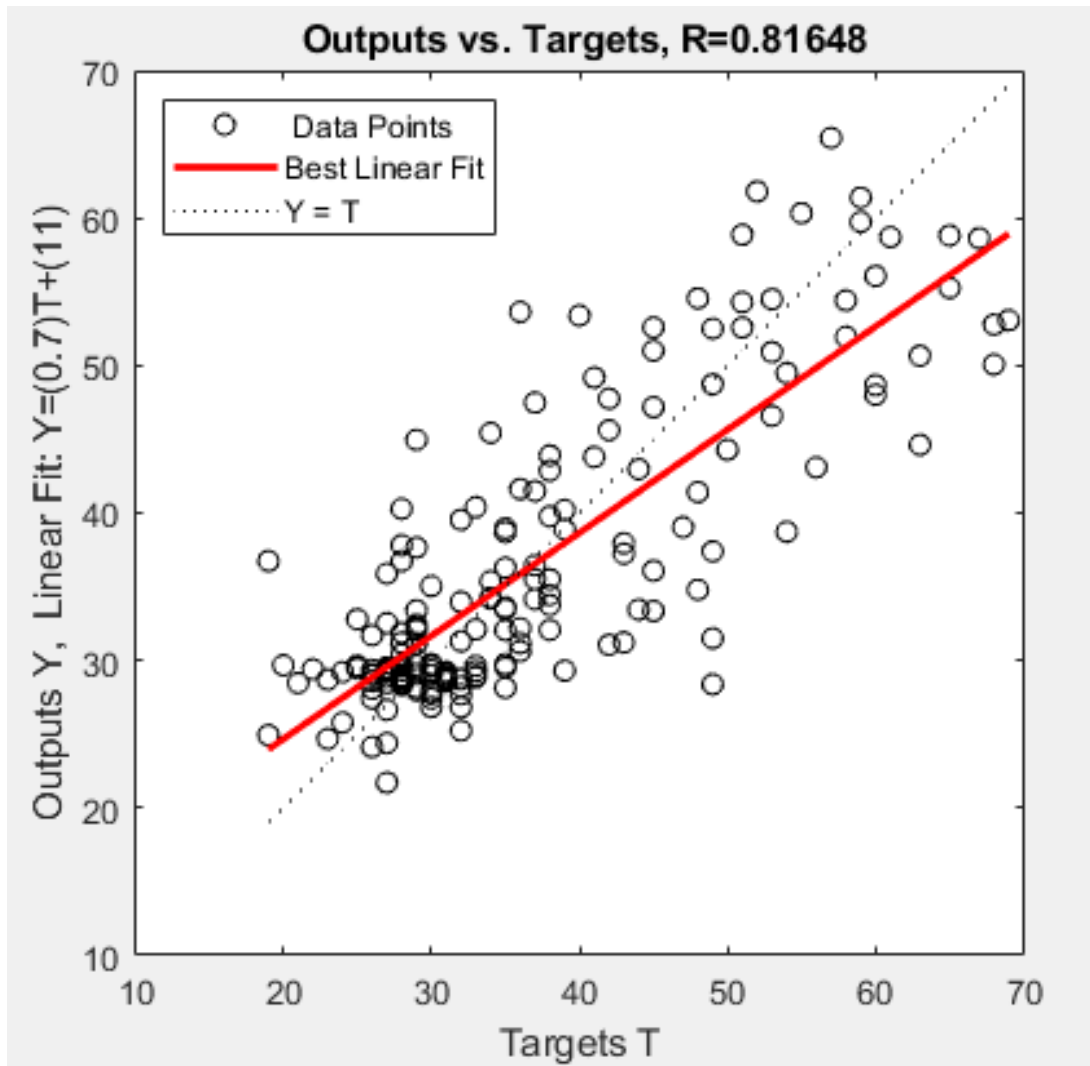


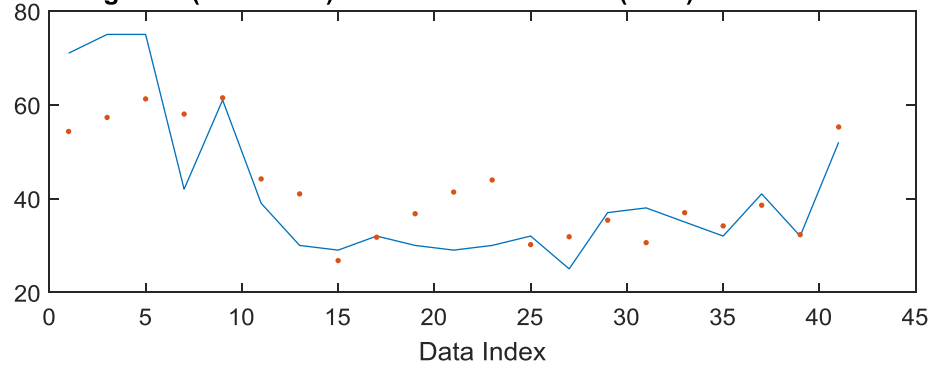
Figure 4.26: Regression plot of experimental and predicted output for the hearing threshold at 6 kHz

**Table 4.11: RMSE and R-values for hearing threshold at 8 kHz**

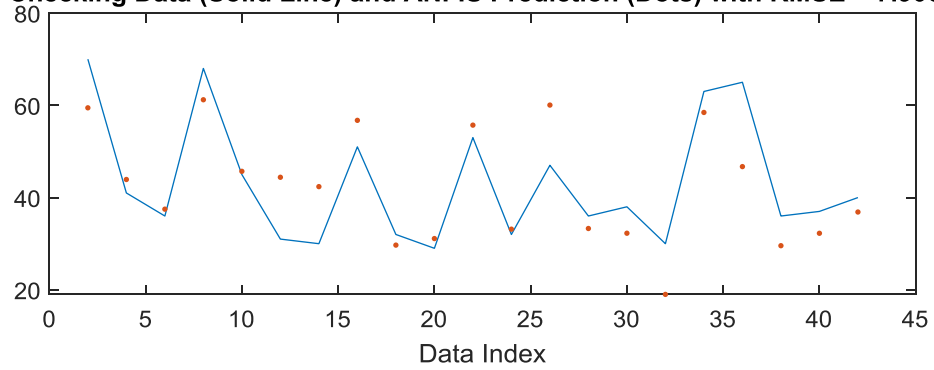
| Input MF type | RMSE     |          | Correlation coefficient (R-value) |
|---------------|----------|----------|-----------------------------------|
|               | Training | Checking |                                   |
| Trimf         | 9.5533   | 11.348   | 0.7719                            |
| Trapmf        | 7.5632   | 9.4475   | 0.7933                            |
| Gbellmf       | 9.0883   | 7.9720   | 0.7968                            |
| Gaussmf       | 8.7029   | 11.0262  | 0.7869                            |
| gauss2mf      | 9.0428   | 7.9062   | 0.7980                            |

MF number: 2, Epoch number = 100, Output MF type: Constant

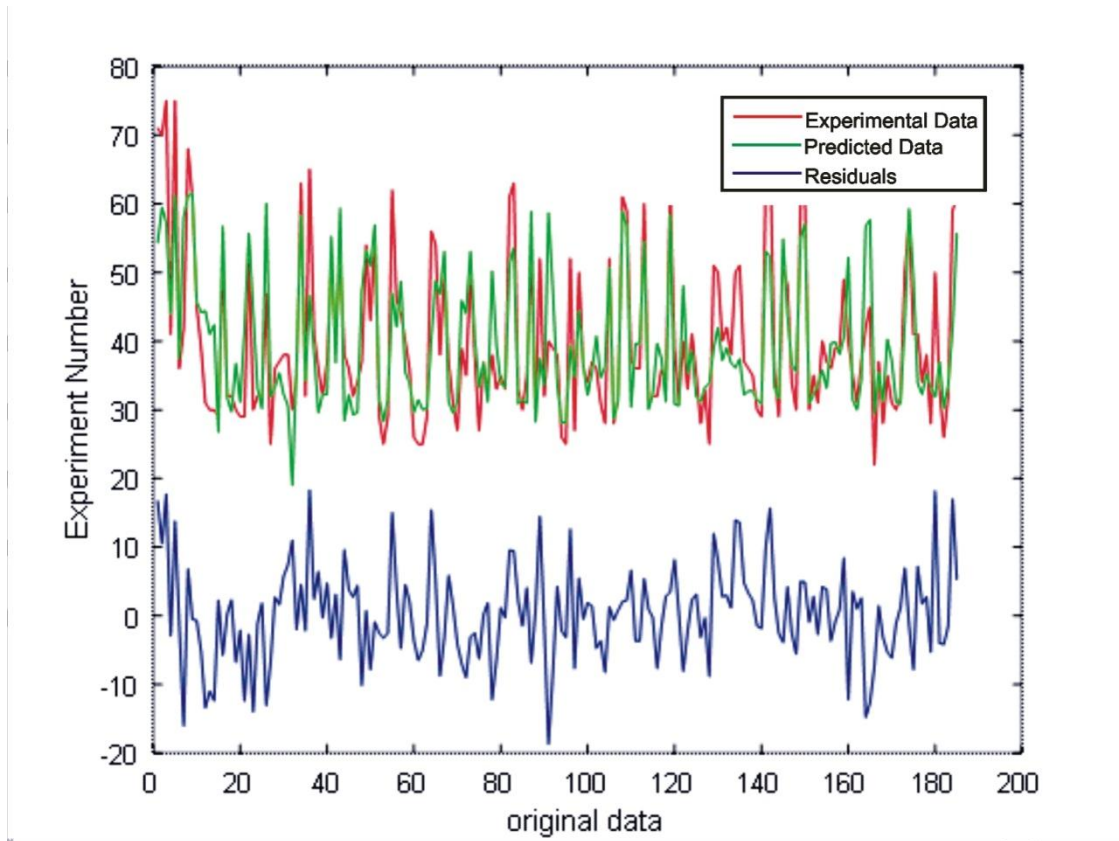
**Training Data (Solid Line) and ANFIS Prediction (Dots) with RMSE = 9.0428**



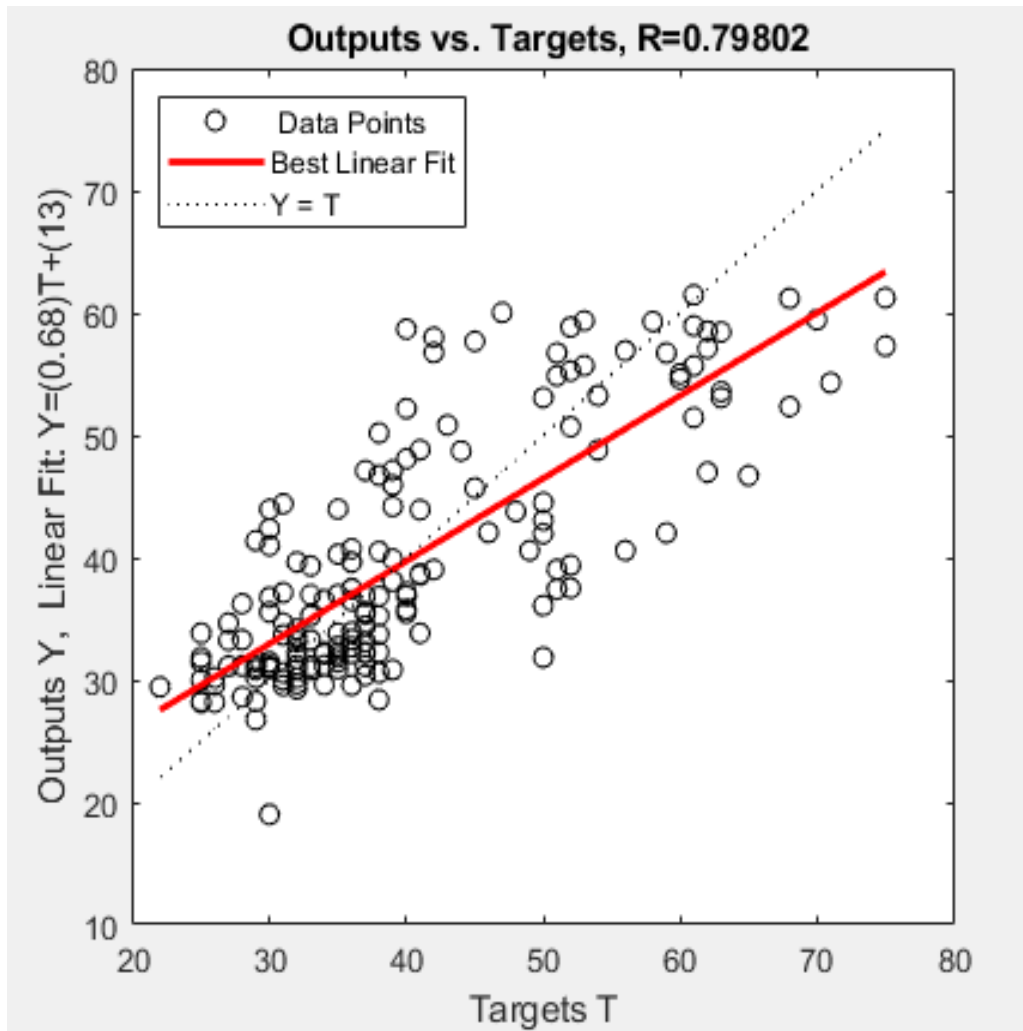
**Checking Data (Solid Line) and ANFIS Prediction (Dots) with RMSE = 7.9062**



**Figure 4.27: Plot of original data against predicted data for model estimation of the hearing threshold at 8 kHz**



**Figure 4.28: Plot of predicted output with residuals for the hearing threshold at 8 kHz**



**Figure 4.29: Regression plot of experimental and predicted output for the hearing threshold at 8 kHz**

## **4.5 ANOVA for Quadratic Models Hearing Threshold outcomes at Various Frequencies**

The analysis of variance (ANOVA) results for the quadratic regression models developed to evaluate the interaction of the studied factors on the hearing threshold of the quarry site workers at various frequencies is here presented.

### **4.5.1 Hearing Threshold at 250 Hz**

In Table 4.12, the model F-value of 95.09 implies that one or more of the independent terms of the model is significant. There is only a 0.01% chance that an F-value this large could occur due to noise. The p-value of less than 0.05 denotes the terms of model are significant. In this case A, C, A<sup>2</sup> are significant model terms. Values greater than 0.05 indicate the model terms are not significant. If there are many insignificant model terms (not counting those required to support hierarchy), variable reduction may improve the model.

The Predicted R<sup>2</sup> of 0.8074 is in reasonable agreement with the Adjusted R<sup>2</sup> of 0.8215 of the model's validity. Adeq Precision measures the signal to noise ratio. A ratio greater than 4 is desirable. The ratio of 50.410 indicates an adequate signal. This model can be used to navigate the design space.

### **4.5.2 Hearing Threshold at 500 Hz**

In Table 4.13, the Model F-value of 70.21 implies the model is significant. There is only a 0.01% chance that an F-value this large could occur due to noise. A p-value less than 0.05 indicate model terms are significant. In this case A, AC, A<sup>2</sup>, C<sup>2</sup> are significant model terms. Values greater than 0.05 indicate the model terms are not significant. If there are many insignificant model terms (not counting those required to support hierarchy), insignificant variables reduction may improve the model.

The Lack of Fit F-value of 0.23 implies there is a 76.30% chance that a Lack of Fit F-value could occur. This ensures the model fitness. The Predicted R<sup>2</sup> value of 0.7604 is in reasonable agreement with the Adjusted R<sup>2</sup> value of 0.7720; i.e. the difference is less than 0.2. Adeq Precision measures the signal to noise ratio. A ratio greater than 4 is desirable.



The ratio of 44.493 indicates an adequate signal. This model can be used to navigate the design space (Montgomery and Runger, 2007).

**Table 4.12: ANOVA for quadratic model for the hearing threshold at 250 Hz**

| <b>Source</b>  | <b>Sum of Squares</b> | <b>df</b> | <b>Mean Square</b> | <b>F-value</b> | <b>p-value</b><br><b>prob&gt;F</b> |             |
|----------------|-----------------------|-----------|--------------------|----------------|------------------------------------|-------------|
| Model          | 1238.82               | 9         | 137.65             | 95.09          | <0.0001                            | Significant |
| A-Age          | 113.89                | 1         | 113.89             | 78.68          | <0.0001                            | Significant |
| B-Exposure     | 4.74                  | 1         | 4.74               | 3.28           | 0.0720                             |             |
| C-Noise level  | 13.17                 | 1         | 13.17              | 9.10           | 0.0029                             | Significant |
| AB             | 0.9044                | 1         | 0.9044             | 0.6248         | 0.4304                             |             |
| AC             | 0.2032                | 1         | 0.2032             | 0.1404         | 0.7084                             |             |
| BC             | 0.7635                | 1         | 0.7635             | 0.5275         | 0.4686                             |             |
| A <sup>2</sup> | 19.63                 | 1         | 19.63              | 13.56          | 0.0003                             | Significant |
| B <sup>2</sup> | 5.34                  | 1         | 5.34               | 3.69           | 0.0563                             |             |
| C <sup>2</sup> | 0.5570                | 1         | 0.5570             | 0.3848         | 0.0537                             | Significant |
| Residual       | 253.32                | 175       | 1.45               |                |                                    |             |
| Lack of Fit    | 253.32                | 172       | 1.47               |                |                                    |             |
| Pure Error     | 0.0000                | 3         | 0.0000             |                |                                    |             |
| Cor Total      | 1492.13               | 184       |                    |                |                                    |             |

R<sup>2</sup>: 0.8302, Adj. R<sup>2</sup>: 0.8215, Pred. R<sup>2</sup>: 0.8074, Adeq. Precision: 50.4099,

Std. Dev.: 1.20, Mean: 25.20, C.V. %: 4.77.

**Table 4.13: ANOVA for quadratic model for the hearing threshold at 500 Hz**

| <b>Source</b>  | <b>Sum of Squares</b> | <b>df</b> | <b>Mean Square</b> | <b>F-value</b> | <b>p-value</b><br><b>prob&gt;F</b> |                 |
|----------------|-----------------------|-----------|--------------------|----------------|------------------------------------|-----------------|
| Model          | 3000.63               | 9         | 333.40             | 70.21          | <0.0001                            | Significant     |
| A-Age          | 256.02                | 1         | 256.02             | 53.91          | <0.0001                            | Significant     |
| B-Exposure     | 6.08                  | 1         | 6.08               | 1.28           | 0.2592                             |                 |
| C-Noise level  | 0.8275                | 1         | 0.8275             | 0.1743         | 0.6769                             |                 |
| AB             | 15.52                 | 1         | 15.52              | 3.27           | 0.0723                             |                 |
| AC             | 51.14                 | 1         | 51.14              | 10.77          | 0.0012                             | Significant     |
| BC             | 5.72                  | 1         | 5.72               | 1.20           | 0.2740                             |                 |
| A <sup>2</sup> | 84.75                 | 1         | 84.75              | 17.85          | <0.0001                            | Significant     |
| B <sup>2</sup> | 0.4409                | 1         | 0.4409             | 0.0929         | 0.7609                             |                 |
| C <sup>2</sup> | 26.85                 | 1         | 26.85              | 5.65           | 0.0185                             | Significant     |
| Residual       | 831.02                | 175       | 4.75               |                |                                    |                 |
| Lack of Fit    | 829.02                | 172       | 4.82               | 0.23           | 0.7630                             | Not significant |
| Pure Error     | 2.00                  | 3         | 0.6667             |                |                                    |                 |
| Cor Total      | 3831.65               | 184       |                    |                |                                    |                 |

R<sup>2</sup>: 0.7831, Adj. R<sup>2</sup>: 0.7720, Pred. R<sup>2</sup>: 0.7604, Adeq. Precision: 44.4930,

Std. Dev.: 2.18, Mean: 28.36, C.V. %: 4.21.

### **4.5.3 Hearing Threshold at 1 kHz**

Table 4.14 gives the Model F-value of 55.79 implies the model is significant. There is only a 0.01% chance that an F-value this large could occur due to noise. A p-value of less than 0.0500 indicate model terms are significant. In this case A, B, A<sup>2</sup> are significant model terms. Values greater than 0.05 indicate the model terms are not significant. If there are many insignificant model terms (not counting those required to support hierarchy), insignificant variables reduction may improve the model.

The Lack of Fit F-value of 0.92 implies the Lack of Fit is not significant relative to the pure error. There is 84.52% chance that a Lack of Fit F-value could occur. Non-significant lack of fit is good, it indicates the model fitness. The Predicted R<sup>2</sup> value of 0.7109 is in reasonable agreement with the Adjusted R<sup>2</sup> value of 0.7282; i.e. the difference is less than 0.2. Adeq Precision measures the signal to noise ratio. A ratio greater than 4 is desirable. The ratio of 35.892 indicates an adequate signal. This model can be used to navigate the design space.

### **4.5.4 Hearing Threshold at 2 kHz**

Table 4.15 gives Model F-value of 66.83 implies the model is significant. There is only a 0.01% chance that an F-value this large could occur due to noise. A p-value of less than 0.0500 means that model terms are significant. In this case A, B, A<sup>2</sup>, C<sup>2</sup> are significant model terms. Values greater than 0.05 indicate the model terms are not significant. If there are many insignificant model terms (not counting those required to support hierarchy), insignificant variables reduction may improve the model.

The Lack of Fit F-value of 0.26 implies the Lack of Fit is not significant relative to the pure error. There is a 77.94% chance that a Lack of Fit F-value could occur. Non-significant lack of fit is good, as it supports the model fitness. The Predicted R<sup>2</sup> value of 0.7462 is in reasonable agreement with the Adjusted R<sup>2</sup> value of 0.7630; i.e. the difference is less than 0.2. Adeq Precision measures the signal to noise ratio. A ratio greater than 4 is desirable. The ratio of 42.705 indicates an adequate signal. This model can be used to navigate the design space.

**Table 4.14: ANOVA for quadratic model for the hearing threshold at 1 kHz**

| Source         | Sum of Squares | df  | Mean Square | F-value  | p-value<br>prob>F |                 |
|----------------|----------------|-----|-------------|----------|-------------------|-----------------|
| Model          | 5227.70        | 9   | 580.86      | 55.79    | <0.0001           | Significant     |
| A-Age          | 245.66         | 1   | 245.66      | 23.59    | <0.0001           | Significant     |
| B-Exposure     | 103.22         | 1   | 103.22      | 9.91     | 0.0019            | Significant     |
| C-Noise Level  | 6.67           | 1   | 6.67        | 0.6404   | 0.4246            |                 |
| AB             | 13.49          | 1   | 13.49       | 1.30     | 0.2566            |                 |
| AC             | 16.91          | 1   | 16.91       | 1.62     | 0.2042            |                 |
| BC             | 7.235E-06      | 1   | 7.235E-06   | 6.948E07 | 0.9993            |                 |
| A <sup>2</sup> | 48.15          | 1   | 48.15       | 4.62     | 0.0329            | Significant     |
| B <sup>2</sup> | 14.31          | 1   | 14.31       | 1.37     | 0.2427            |                 |
| C <sup>2</sup> | 39.97          | 1   | 39.97       | 3.84     | 0.0517            |                 |
| Residual       | 1822.08        | 175 | 10.41       |          |                   |                 |
| Lack of Fit    | 1788.08        | 172 | 10.40       | 0.9173   | 0.8452            | Not significant |
| Pure Error     | 34.00          | 3   | 11.33       |          |                   |                 |
| Cor Total      | 7049.78        | 184 |             |          |                   |                 |

R<sup>2</sup>: 0.7415, Adj. R<sup>2</sup>: 0.7282, Pred. R<sup>2</sup>:0.7109, Adeq. Precision: 35.8918,

Std. Dev.: 3.23, Mean: 31.72, C.V. %: 4.74.

**Table 4.15: ANOVA for quadratic model for the hearing threshold at 2 kHz**

| <b>Source</b>    | <b>Sum<br/>Squares</b> | <b>of<br/>df</b> | <b>Mean<br/>Square</b> | <b>F-<br/>value</b> | <b>p-value<br/>prob&gt;F</b> |                 |
|------------------|------------------------|------------------|------------------------|---------------------|------------------------------|-----------------|
| Model            | 8399.39                | 9                | 933.27                 | 66.83               | <0.0001                      | Significant     |
| A-Age            | 501.99                 | 1                | 501.99                 | 35.95               | <0.0001                      | Significant     |
| B-Exposure       | 97.54                  | 1                | 97.54                  | 6.99                | 0.0090                       | Significant     |
| C-Noise<br>Level | 0.3885                 | 1                | 0.3885                 | 0.0278              | 0.8677                       |                 |
| AB               | 24.75                  | 1                | 24.75                  | 1.77                | 0.1848                       |                 |
| AC               | 41.28                  | 1                | 41.28                  | 2.96                | 0.0873                       |                 |
| BC               | 0.0375                 | 1                | 0.0375                 | 0.0027              | 0.9587                       |                 |
| A <sup>2</sup>   | 163.03                 | 1                | 163.03                 | 11.68               | 0.0008                       | Significant     |
| B <sup>2</sup>   | 0.8334                 | 1                | 0.8334                 | 0.0597              | 0.8073                       |                 |
| C <sup>2</sup>   | 103.77                 | 1                | 103.77                 | 7.43                | 0.0071                       | Significant     |
| Residual         | 2443.66                | 175              | 13.96                  |                     |                              |                 |
| Lack of Fit      | 2430.66                | 172              | 14.13                  | 0.26                | 0.7794                       | Not significant |
| Pure Error       | 13.00                  | 3                | 4.33                   |                     |                              |                 |
| Cor Total        | 10843.05               | 184              |                        |                     |                              |                 |

R<sup>2</sup>: 0.7746, Adj. R<sup>2</sup>: 0.7630, Pred. R<sup>2</sup>: 0.7462, Adeq. Precision: 42.7045,

Std. Dev.: 3.74, Mean: 35.73, C.V. %: 3.25.

#### **4.5.5 Hearing Threshold at 3 kHz**

In Table 4.16, the Model F-value of 88.17 implies the model is significant. There is only a 0.01% chance that an F-value this large could occur due to noise. A p-value less than 0.0500 indicate model terms are significant. In this case A, B<sup>2</sup> are significant model terms. Values greater than 0.0500 indicate the model terms are not significant. If there are many insignificant model terms (not counting those required to support hierarchy), insignificant variables reduction may improve the model.

The Lack of Fit F-value of 0.90 implies the Lack of Fit is not significant relative to the pure error. There is 78.34% chance that a Lack of Fit F-value could occur. Non-significant lack of fit is good which indicates the model fitness. The Predicted R<sup>2</sup> value of 0.7951 is in reasonable agreement with the Adjusted R<sup>2</sup> value of 0.8100; i.e. the difference is less than 0.2. Adeq Precision measures the signal to noise ratio. A ratio greater than 4 is desirable. The ratio of 44.807 indicates an adequate signal. This model can be used to navigate the design space.

#### **4.5.6 Hearing threshold at 4 kHz**

Table 4.17 gives the Model F-value of 106.30, which implies the model is significant. There is only a 0.01% chance that an F-value this large could occur due to noise. A p-value of less than 0.0500 implies that model terms are significant. In this case A, and AB are significant model terms. Values greater than 0.0500 indicate the model terms are not significant. If there are many insignificant model terms (not counting those required to support hierarchy), insignificant variables reduction may improve the model.

The Lack of Fit F-value of 0.87 implies the Lack of Fit is not significant relative to the pure error. There is an 80.95% chance that a Lack of Fit F-value could occur. Non-significant lack of fit is good, which ensures the model fitness. The Predicted R<sup>2</sup> of 0.8206 is in reasonable agreement with the Adjusted R<sup>2</sup> of 0.8374; i.e. the difference is less than 0.2. Adeq Precision measures the signal to noise ratio. A ratio greater than 4 is desirable. The ratio of 50.354 indicates an adequate signal. This model can be used to navigate the design space.

**Table 4.16: ANOVA for quadratic model for the hearing threshold at 3 kHz**

| Source         | Sum of Squares | df  | Mean Square | F-value | p-value | prob>F          |
|----------------|----------------|-----|-------------|---------|---------|-----------------|
| Model          | 12722.24       | 9   | 1413.58     | 88.17   | <0.0001 | Significant     |
| A-Age          | 1480.27        | 1   | 1480.27     | 92.33   | <0.0001 | Significant     |
| B-Exposure     | 2.31           | 1   | 2.31        | 0.1443  | 0.7045  |                 |
| C-Noise Level  | 15.95          | 1   | 15.95       | 0.9946  | 0.3200  |                 |
| AB             | 24.30          | 1   | 24.30       | 1.52    | 0.2199  |                 |
| AC             | 2.68           | 1   | 2.68        | 0.1669  | 0.6834  |                 |
| BC             | 21.00          | 1   | 21.00       | 1.31    | 0.2540  |                 |
| A <sup>2</sup> | 62.31          | 1   | 62.31       | 3.89    | 0.0503  |                 |
| B <sup>2</sup> | 124.62         | 1   | 124.62      | 7.77    | 0.0059  | Significant     |
| C <sup>2</sup> | 61.05          | 1   | 61.05       | 3.81    | 0.0526  |                 |
| Residual       | 2805.68        | 175 | 16.03       |         |         |                 |
| Lack of Fit    | 2793.18        | 172 | 16.24       | 0.90    | 0.7834  | Not significant |
| Pure Error     | 12.50          | 3   | 4.17        |         |         |                 |
| Cor Total      | 15527.92       | 184 |             |         |         |                 |

R<sup>2</sup>: 0.8193, Adj. R<sup>2</sup>: 0.8100, Pred. R<sup>2</sup>:0.7951, Adeq. Precision: 44.8068,

Std. Dev.: 4.00, Mean: 38.81, C.V. %: 2.75



**Table 4.17: ANOVA for quadratic model for the hearing threshold at 4 kHz**

| <b>Source</b>  | <b>Sum of Squares</b> | <b>df</b> | <b>Mean Square</b> | <b>F-value</b> | <b>p-value</b><br><b>prob&gt;F</b> |                 |
|----------------|-----------------------|-----------|--------------------|----------------|------------------------------------|-----------------|
| Model          | 36670.15              | 9         | 4074.46            | 106.30         | <0.0001                            | Significant     |
| A-Age          | 3231.75               | 1         | 3231.75            | 84.31          | <0.0001                            | Significant     |
| B-Exposure     | 119.71                | 1         | 119.71             | 3.12           | 0.0789                             |                 |
| C-Noise Level  | 26.42                 | 1         | 26.42              | 0.6892         | 0.4076                             |                 |
| AB             | 234.63                | 1         | 234.63             | 6.12           | 0.0143                             | Significant     |
| AC             | 1.59                  | 1         | 1.59               | 0.0414         | 0.8390                             |                 |
| BC             | 6.39                  | 1         | 6.39               | 0.1666         | 0.6836                             |                 |
| A <sup>2</sup> | 1.11                  | 1         | 1.11               | 0.0289         | 0.8653                             |                 |
| B <sup>2</sup> | 112.41                | 1         | 112.41             | 2.93           | 0.0886                             |                 |
| C <sup>2</sup> | 0.0119                | 1         | 0.0119             | 0.0003         | 0.9860                             |                 |
| Residual       | 6707.88               | 175       | 38.33              |                |                                    |                 |
| Lack of Fit    | 6667.38               | 172       | 38.76              | 0.87           | 0.8095                             | Not significant |
| Pure Error     | 40.50                 | 3         | 13.50              |                |                                    |                 |
| Cor Total      | 43378.03              | 184       |                    |                |                                    |                 |

R<sup>2</sup>: 0.8454, Adj. R<sup>2</sup>: 0.8374, Pred. R<sup>2</sup>:0.8206, Adeq. Precision: 50.3536,

Std. Dev.: 6.19, Mean: 47.77, C.V. %: 2.56.

#### **4.5.7 Hearing threshold at 6 kHz**

In Table 4.18, the Model F-value of 65.29 implies that the model is significant. There is only a 0.01% chance that an F-value this large could occur due to noise. A p-value of less than 0.0500 denotes that model terms are significant. In this case A is a significant model term. Values greater than 0.0500 indicate the model terms are not significant. If there are many insignificant model terms (not counting those required to support hierarchy), insignificant variables reduction may improve the model.

The Lack of Fit F-value of 6.16 implies there is a 17.85% chance that a Lack of Fit F-value this large could occur due to noise. Lack of fit is bad. The Predicted R<sup>2</sup> value of 0.7291 is in reasonable agreement with the Adjusted R<sup>2</sup> value of 0.7587; i.e. the difference is less than 0.2. Adeq Precision measures the signal to noise ratio. A ratio greater than 4 is desirable. The ratio of 38.820 indicates an adequate signal. This model can be used to navigate the design space.

#### **4.5.8 Hearing threshold at 8 kHz**

Table 4.19 shows the Model F-value of 73.01; this implies that the model is significant. There is only a 0.01% chance that an F-value this large could occur due to noise. A p-value of less than 0.0500 showed that model terms are significant. In this case A is a significant model term. Values greater than 0.0500 indicate the model terms are not significant. If there are many insignificant model terms (not counting those required to support hierarchy), insignificant variables reduction may improve the model.

The Lack of Fit F-value of 0.77 implies the Lack of Fit is not significant relative to the pure error. There is a 78.61% chance that a Lack of Fit F-value could occur. Non-significant lack of fit is good, it favours the model fitness. The Predicted R<sup>2</sup> value of 0.7667 is in reasonable agreement with the Adjusted R<sup>2</sup> value of 0.7789; i.e. the difference is less than 0.2. Adeq Precision measures the signal to noise ratio. A ratio greater than 4 is desirable. The ratio of 40.291 indicates an adequate signal. This model can be used to navigate the design space.

**Table 4.18: ANOVA for quadratic response model for the hearing threshold at 6 kHz**

| <b>Source</b>  | <b>Sum of Squares</b> | <b>df</b> | <b>Mean Square</b> | <b>F-value</b> | <b><u>p-value</u><br/>prob&gt;F</b> |                 |
|----------------|-----------------------|-----------|--------------------|----------------|-------------------------------------|-----------------|
| Model          | 15448.56              | 9         | 1716.51            | 65.29          | <0.0001                             | Significant     |
| A-Age          | 1249.15               | 1         | 1249.15            | 47.51          | <0.0001                             | Significant     |
| B-Exposure     | 79.62                 | 1         | 79.62              | 3.03           | 0.0836                              |                 |
| C-Noise Level  | 56.54                 | 1         | 56.54              | 2.15           | 0.1443                              |                 |
| AB             | 33.77                 | 1         | 33.77              | 1.28           | 0.2586                              |                 |
| AC             | 11.20                 | 1         | 11.20              | 0.4262         | 0.5147                              |                 |
| BC             | 5.27                  | 1         | 5.27               | 0.2003         | 0.6551                              |                 |
| A <sup>2</sup> | 16.98                 | 1         | 16.98              | 0.6460         | 0.4226                              |                 |
| B <sup>2</sup> | 14.36                 | 1         | 14.36              | 0.5463         | 0.4608                              |                 |
| C <sup>2</sup> | 35.70                 | 1         | 35.70              | 1.36           | 0.2455                              |                 |
| Residual       | 4600.86               | 175       | 26.29              |                |                                     |                 |
| Lack of Fit    | 4587.86               | 172       | 26.67              | 6.16           | 0.1785                              | Not significant |
| Pure Error     | 13.00                 | 3         | 4.33               |                |                                     |                 |
| Cor Total      | 20049.42              | 184       |                    |                |                                     |                 |

R<sup>2</sup>: 0.7705, Adj. R<sup>2</sup>: 0.7587, Pred. R<sup>2</sup>: 0.7291, Adeq. Precision: 38.8199,

Std. Dev.: 5.13, Mean: 36.70, C.V. %: 3.18.

**Table 4.19: ANOVA for quadratic model for the hearing threshold at 8 kHz**

| <b>Source</b>  | <b>Sum of Squares</b> | <b>df</b> | <b>Mean Square</b> | <b>F-value</b> | <b>p-value</b> | <b>prob &gt;F</b> |
|----------------|-----------------------|-----------|--------------------|----------------|----------------|-------------------|
| Model          | 16598.66              | 9         | 1844.30            | 73.01          | <0.0001        | Significant       |
| A-Age          | 1815.20               | 1         | 1815.20            | 71.86          | <0.0001        | Significant       |
| B-Exposure     | 6.23                  | 1         | 6.23               | 0.2467         | 0.6200         |                   |
| C-Noise Level  | 20.35                 | 1         | 20.35              | 0.8054         | 0.3707         |                   |
| AB             | 38.92                 | 1         | 38.92              | 1.54           | 0.2162         |                   |
| AC             | 54.15                 | 1         | 54.15              | 2.14           | 0.1450         |                   |
| BC             | 84.86                 | 1         | 84.86              | 3.36           | 0.0685         |                   |
| A <sup>2</sup> | 5.10                  | 1         | 5.10               | 0.2019         | 0.6537         |                   |
| B <sup>2</sup> | 5.32                  | 1         | 5.32               | 0.2108         | 0.6467         |                   |
| C <sup>2</sup> | 63.89                 | 1         | 63.89              | 2.53           | 0.1136         |                   |
| Residual       | 4420.70               | 175       | 25.26              |                |                |                   |
| Lack of Fit    | 4322.20               | 172       | 25.13              | 0.7654         | 0.7861         | Not significant   |
| Pure Error     | 98.50                 | 3         | 32.83              |                |                |                   |
| Cor Total      | 21019.35              | 184       |                    |                |                |                   |

R<sup>2</sup>: 0.7897, Adj. R<sup>2</sup>: 0.7789, Pred. R<sup>2</sup>: 0.7667, Adeq. Precision: 40.2909,

Std. Dev.: 5.03, Mean: 40.27, C.V. %: 4.52.

#### **4.6 Model Equation in Terms of Actual Factors at Frequency 250 Hz, 500 Hz, 1 kHz, 2 kHz, 3 kHz, 4 kHz, 6 kHz and 8 kHz**

The model equations derived from the ANOVA by partial SS (Type III) from the MATLAB in Design Expert version 6.0.8 are shown (Equations 4.1- 4.8). Initially the equation was set to the cubic form which MATLAB proved it to be infeasible, but only feasible in form of quadratic equation form. The equations exist in terms of actual factors from Design – Expert 6.0.8 software, which can be used to make predictions about the hearing threshold for a given frequency of each factor. Here, the levels (frequency) should be specified in the original units for each factor. It is worth noting that the equations cannot be used to determine the relative impact of each factor because the coefficients are scaled to accommodate the units of each factor and the intercept is not at the center of the design space.

##### **(A) Hearing Threshold at 250 Hz**

$$HT_{250\text{Hz}} = 44.14033 + 0.591251AG + 0.390885YE - 0.186337NL - 0.005017AG*YE - 0.000790AG*NL + 0.001839YE*NL - 0.012083AG^2 - 0.008045YE^2 - 0.001079NL^2 \quad (4.1)$$

##### **(B) Hearing Threshold at 500 Hz**

$$HT_{500\text{Hz}} = 337.4358 - 2.60847AG + 1.35031YE - 1.96007NL - 0.020783AG*YE \quad (4.2)$$

##### **(C) Hearing Threshold at 1 kHz**

$$HT_{1\text{kHz}} = 48.123758 - 1.58652AG + 0.554330YE - 2.18851NL - 0.019374AG*YE + 0.007206AG*NL + 5.65979E-06YE*NL + 0.018925AG^2 + 0.013165YE^2 + 0.009144NL^2 \quad (4.3)$$

##### **(D) Hearing Threshold at 2 kHz**

$$HT_{2\text{kHz}} = 196.76191 - 3.03851AG + 1.51158YE - 3.47315NL - 0.026243AG*YE + 0.011258AG*NL - 0.000408YE*NL + 0.034824AG^2 \quad (4.4)$$

**(E) Hearing Threshold at 3 kHz**

$$HT_{3\text{kHz}} = 60.88191 - 1.16049AG - 0.508885YE - 2.34256NL + 0.026004AG*YE - 0.002867AG*NL + 0.009643YE*NL + 0.021528AG^2 - 0.038853YE^2 + 0.011301NL^2 \quad (4.5)$$

**(F) Hearing Threshold at 4 kHz**

$$HT_{4\text{kHz}} = 104.26160 - 0.346203AG - 1.08671YE + 0.119216NL - 0.080805AG*YE - 0.002207AG*NL - 0.005318YE*NL + 0.002869AG^2 - 0.036901YE^2 + 0.000158NL^2 \quad (4.6)$$

**(G) Hearing threshold at 6 kHz**

$$HT_{6\text{kHz}} = 35.080805 - 0.159487AG - 1.01857YE - 1.67968NL + 0.030655AG*YE - 0.005865AG*NL + 0.004828YE*NL + 0.011240AG^2 - 0.013190YE^2 + 0.008642NL^2 \quad (4.7)$$

**(H) Hearing threshold at 8 kHz**

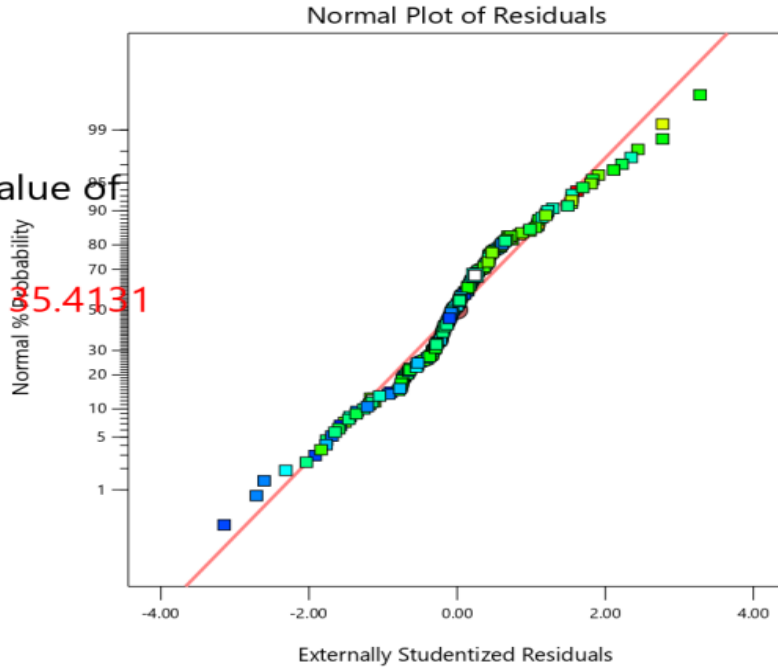
$$HT_{8\text{kHz}} = 87.26089 - 1.53852AG + 0.991447YE - 2.55636NL + 0.032911AG*YE + 0.019384YE*NL + 0.006159AG^2 - 0.008031YE^2 + 0.011561NL^2 \quad (4.8)$$

**4.7 Normal Probability Plot of Residuals and Predicted Output for Hearing Threshold at Different Frequencies**

In Figures 4.30 – 4.37, the normal probability plot of residuals and predicted output for range of frequency 250 Hz – 8 kHz indicated the adequacy of the developed model for the hearing threshold; having all data points aligned on straight line.

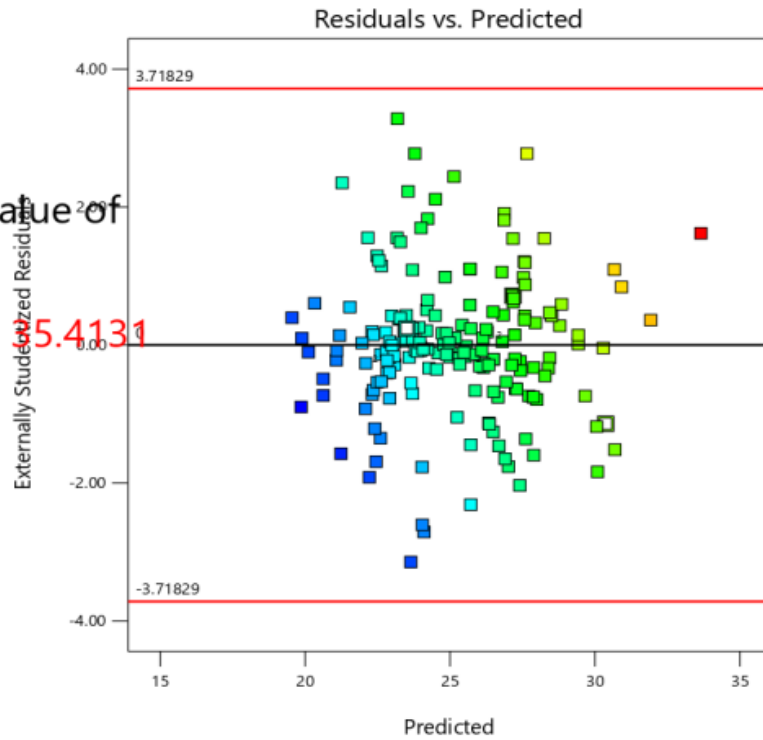
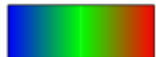
**250**

Color points by value of  
250:  
18.8466 5.4131



**250**

Color points by value of  
250:  
18.8466 5.4131



**Figure 4.30: Normal probability plot of residuals and predicted output for hearing threshold at 250 Hz**

500

Color points by value of

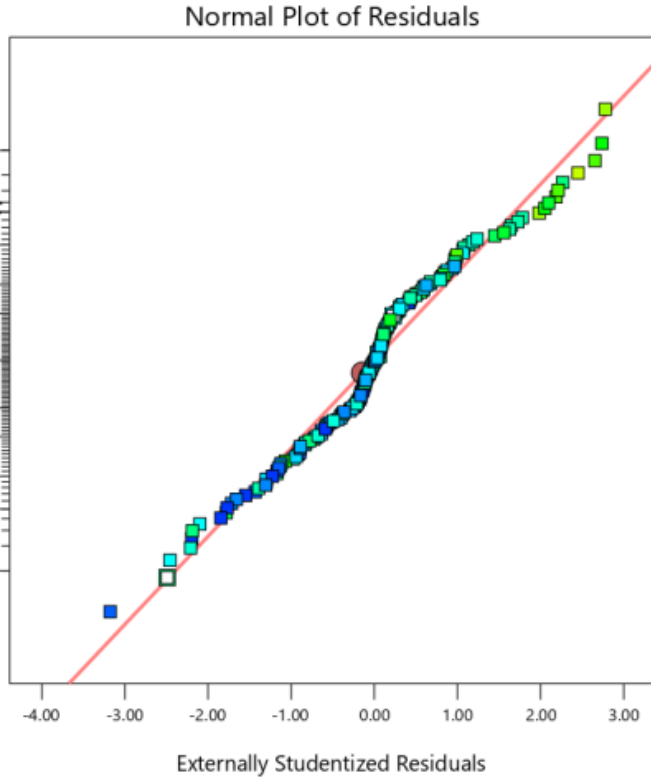
500:

20.651



Normal % Probability

40.663

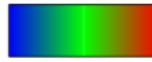


500

Color points by value of

500:

20.651



40.663

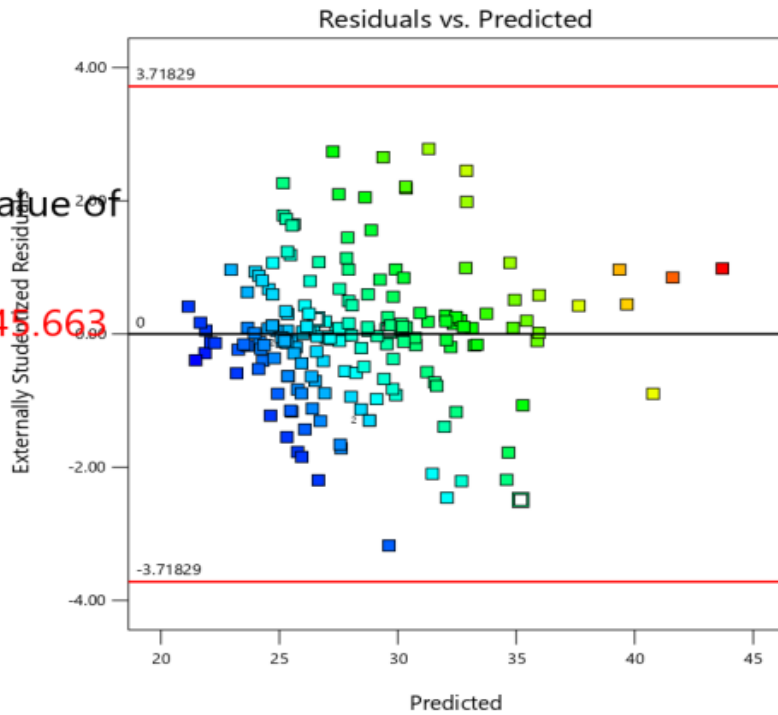


Figure 4.31: Normal probability plot of residuals and predicted output for the hearing threshold at 500 Hz

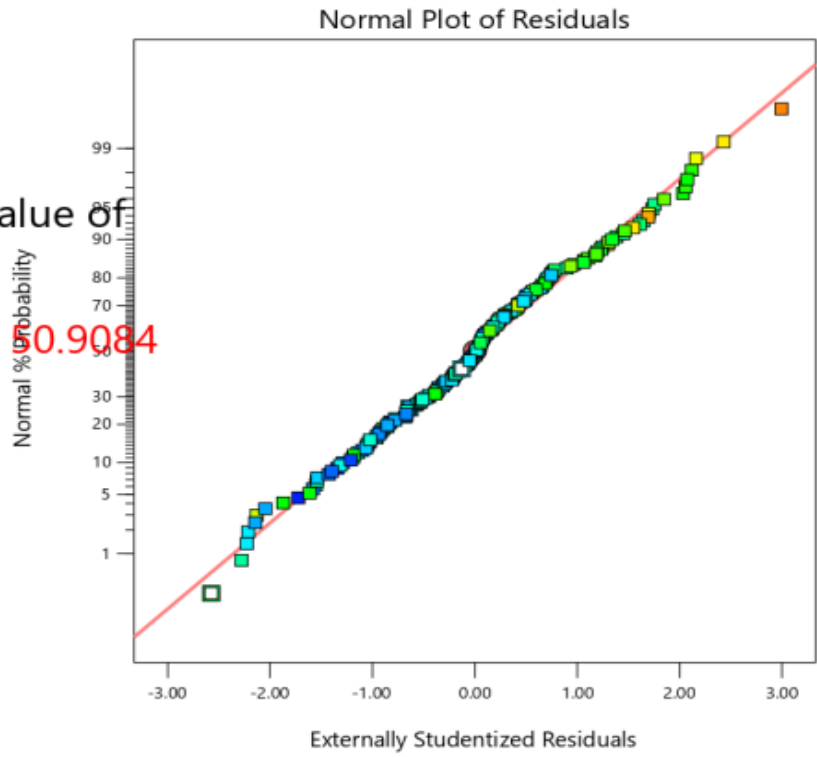
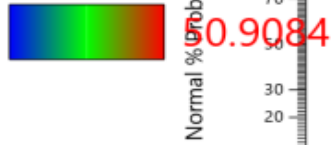


1

Color points by value of

1:

21



1

Color points by value of

1:

21

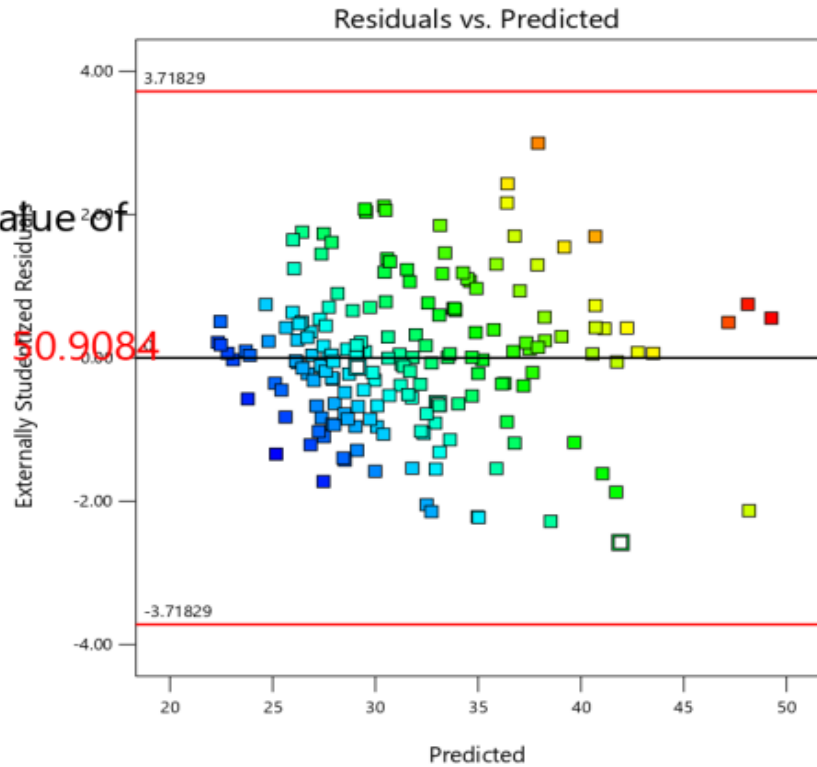
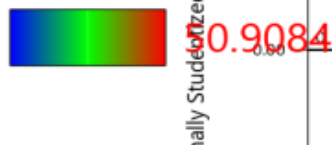


Figure 4.32: Normal probability plot of residuals and predicted output for the hearing threshold at 1 kHz

2

Color points by value of

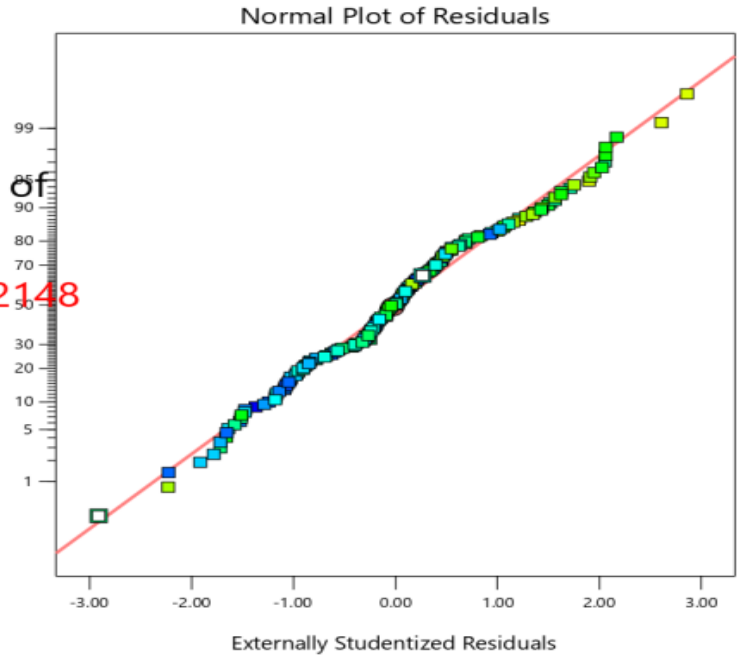
2:

22



0.1.2148

Normal % Probability



2

Color points by value of

2:

22



0.1.2148

Externally Studentized Residuals

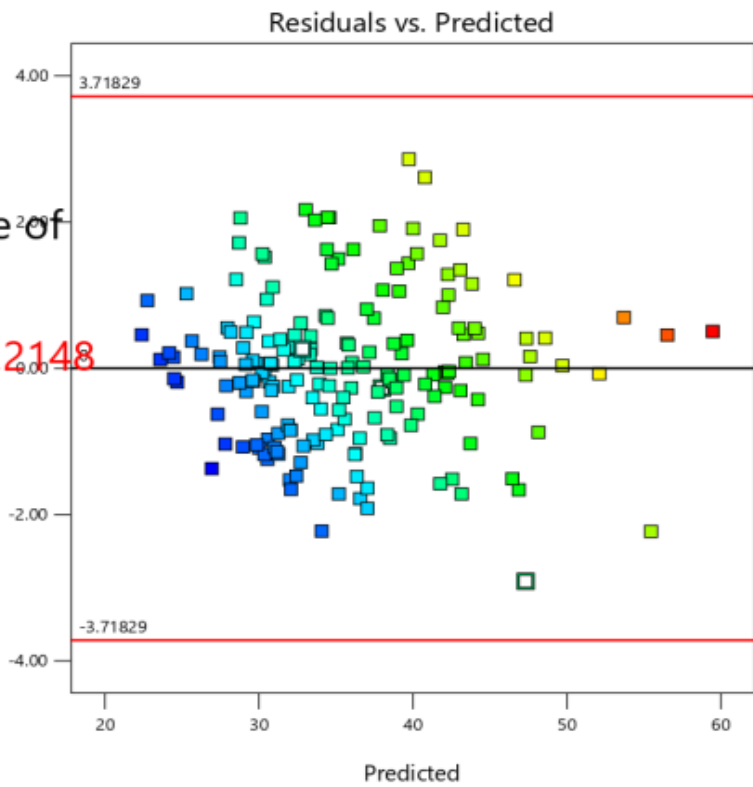


Figure 4.33: Normal probability plot of residuals and predicted output for the hearing threshold at 2 kHz

3

Color points by value of

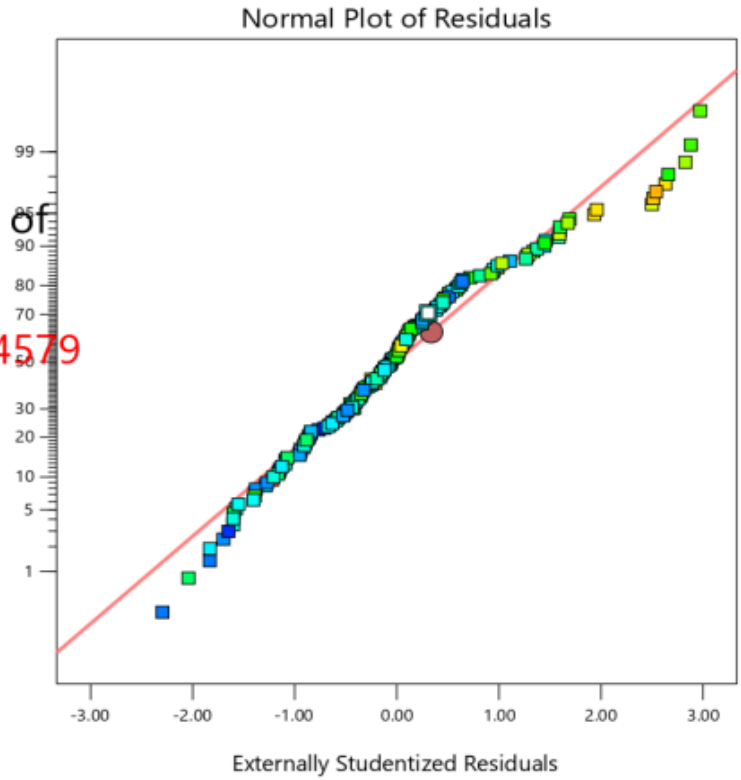
3:

23



65.4579

Normal % Probability



3

Color points by value of

3:

23



65.4579

Externally Studentized Residuals

Std # 98 Run # 98

X: 44.3584

Y: 0.924

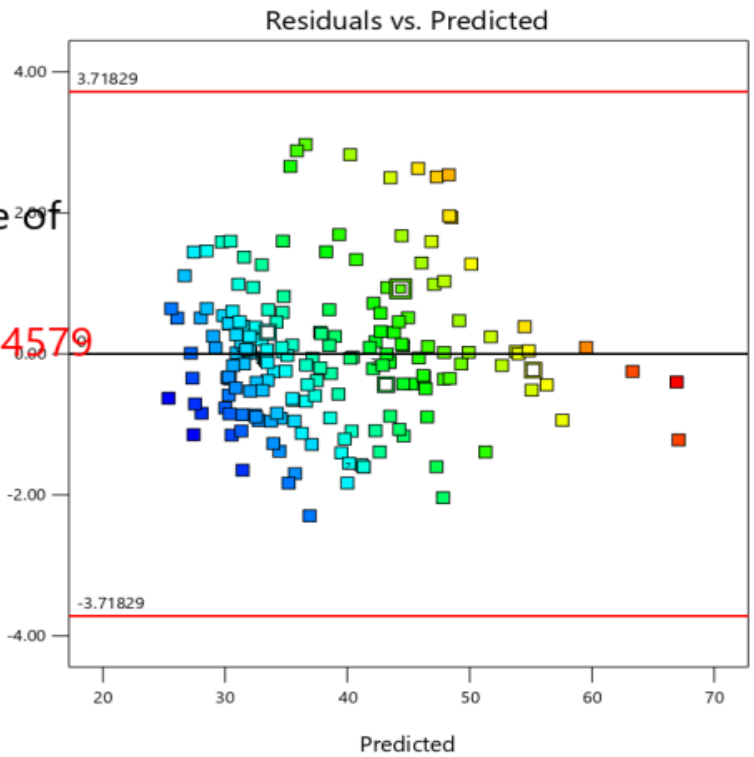


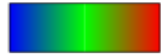
Figure 4.34: Normal probability plot of residuals and predicted output for the hearing threshold at 3 kHz

4

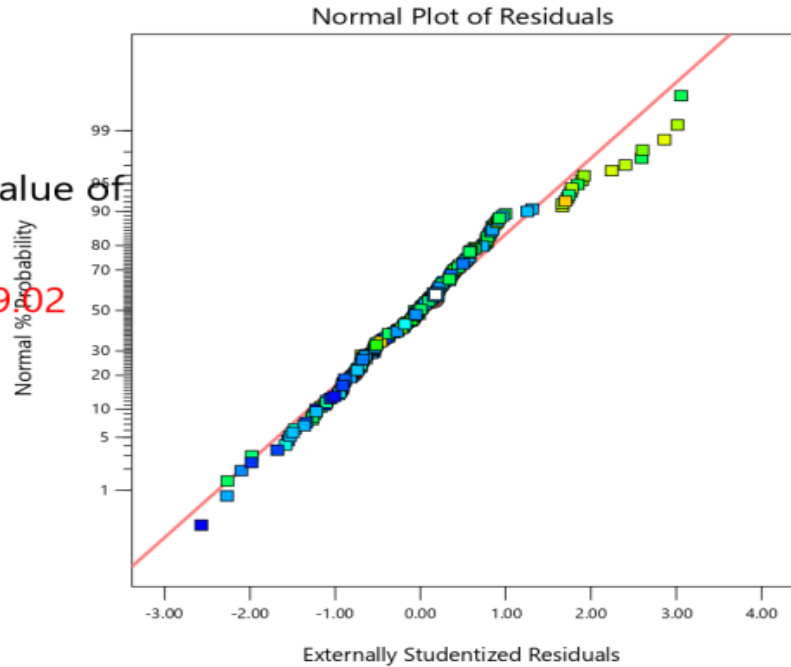
Color points by value of

4:

26.2



99.02



4

Color points by value of

4:

26.2



99.02

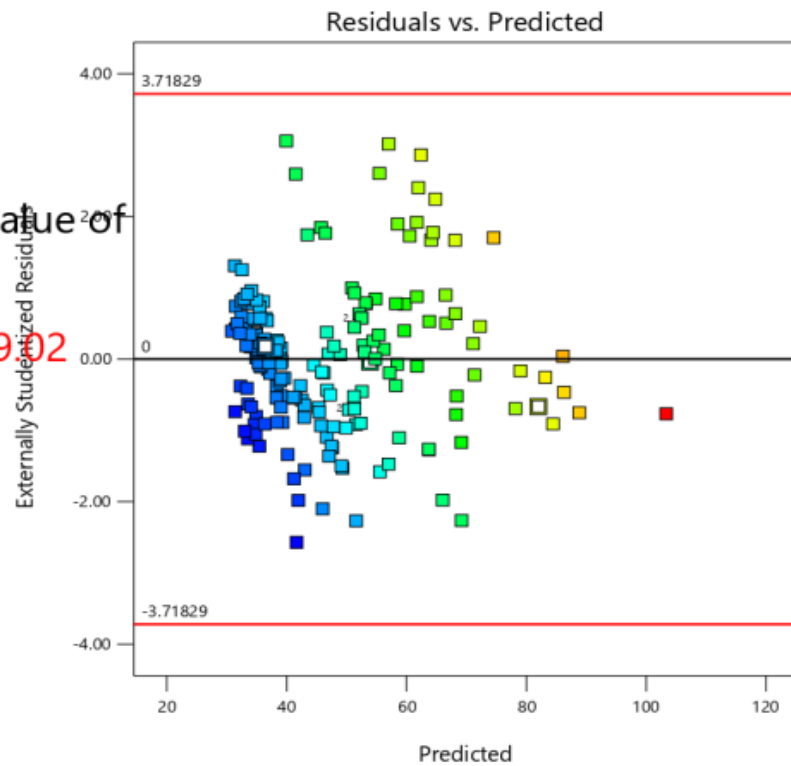
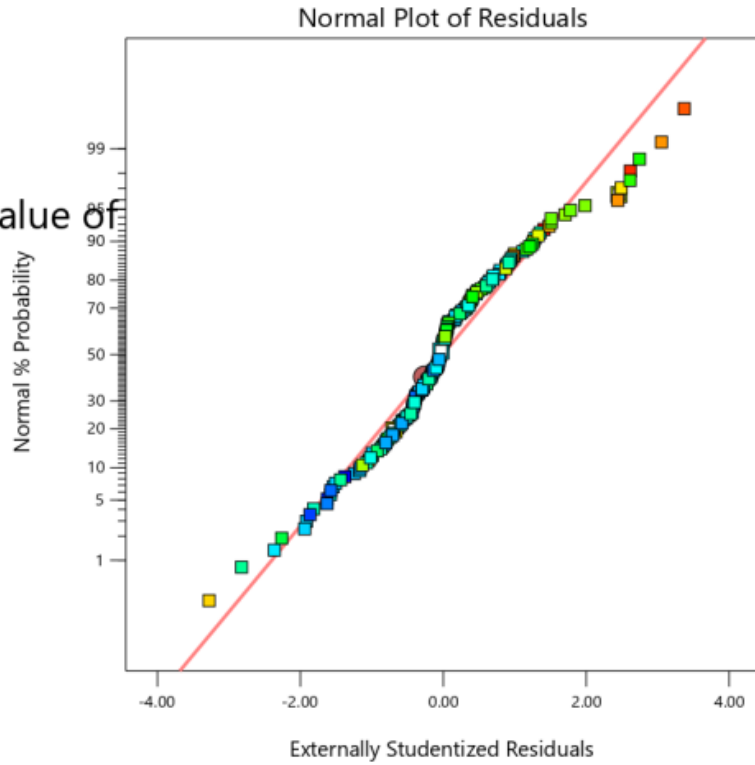


Figure 4.35: Normal probability plot of residuals and predicted output for the hearing threshold at 4 kHz

6

Color points by value of

6:



6

Color points by value of

6:

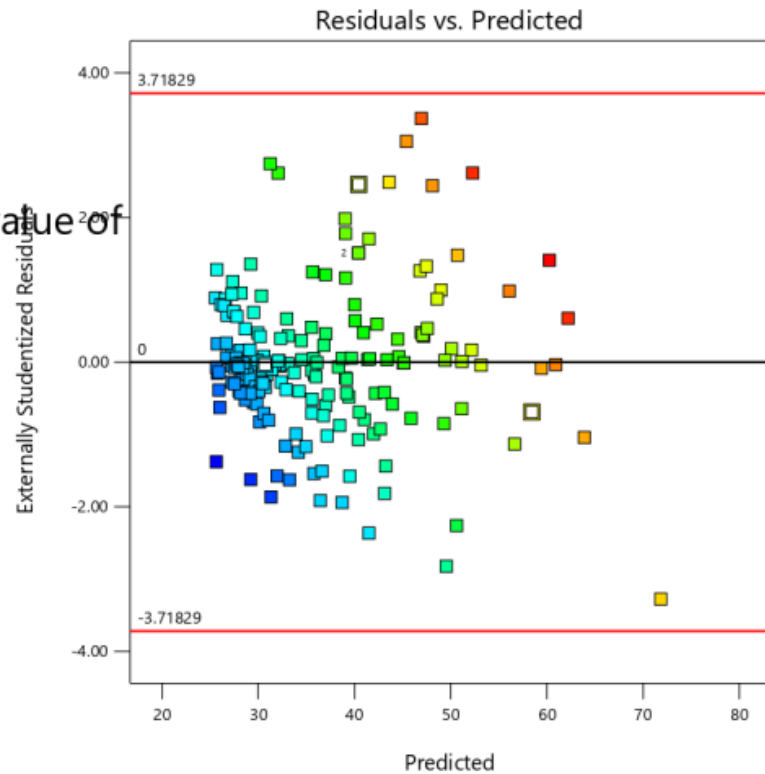


Figure 4.36: Normal probability plot of residuals and predicted output for the hearing threshold at 6 kHz

8

Color points by value of

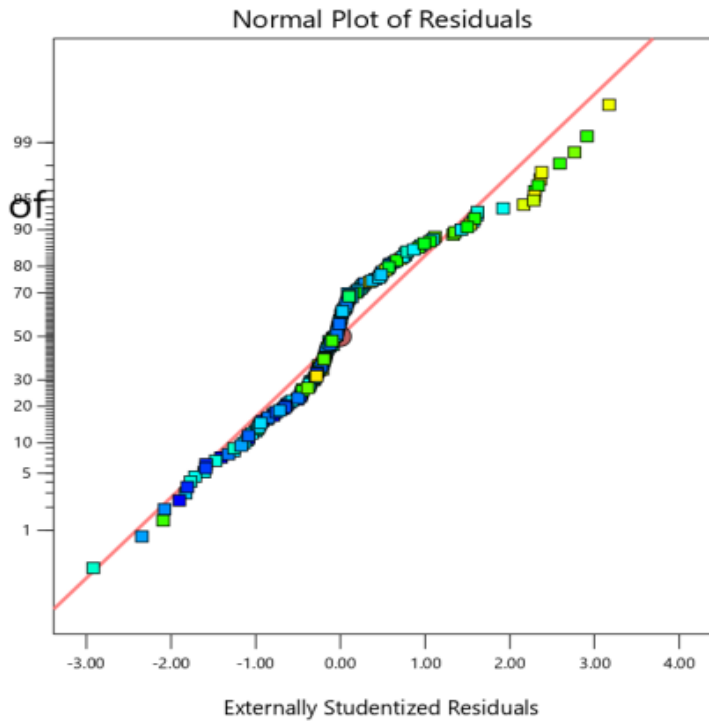
8:

25



75 15

Normal % Probability

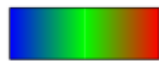


8

Color points by value of

8:

25



75 15

Externally Studentized Residuals

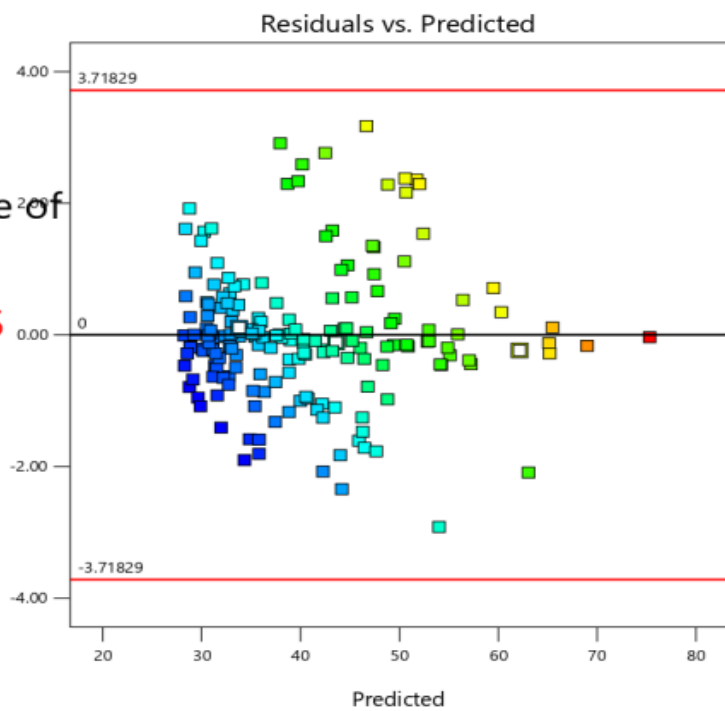


Figure 4.37: Normal probability plot of residuals and predicted output for the hearing threshold at 8 kHz

## **4.8 Effect of Single Factors on the Hearing Threshold at Various Frequencies**

### **(A) Hearing threshold at frequency 250 Hz**

As shown in Figure 4.38, the hearing threshold increases with the age of the workers, while it decreases with the year of exposure and the noise level. This implies that none of age, years of exposure and noise level can be considered as the most contributory factor. More, so the exhaustive search was unable to determine the most significant factor. Therefore effects of any of the 3 factors on hearing threshold could not be ascertained at this frequency.

### **(B) Hearing threshold at frequency 500 Hz**

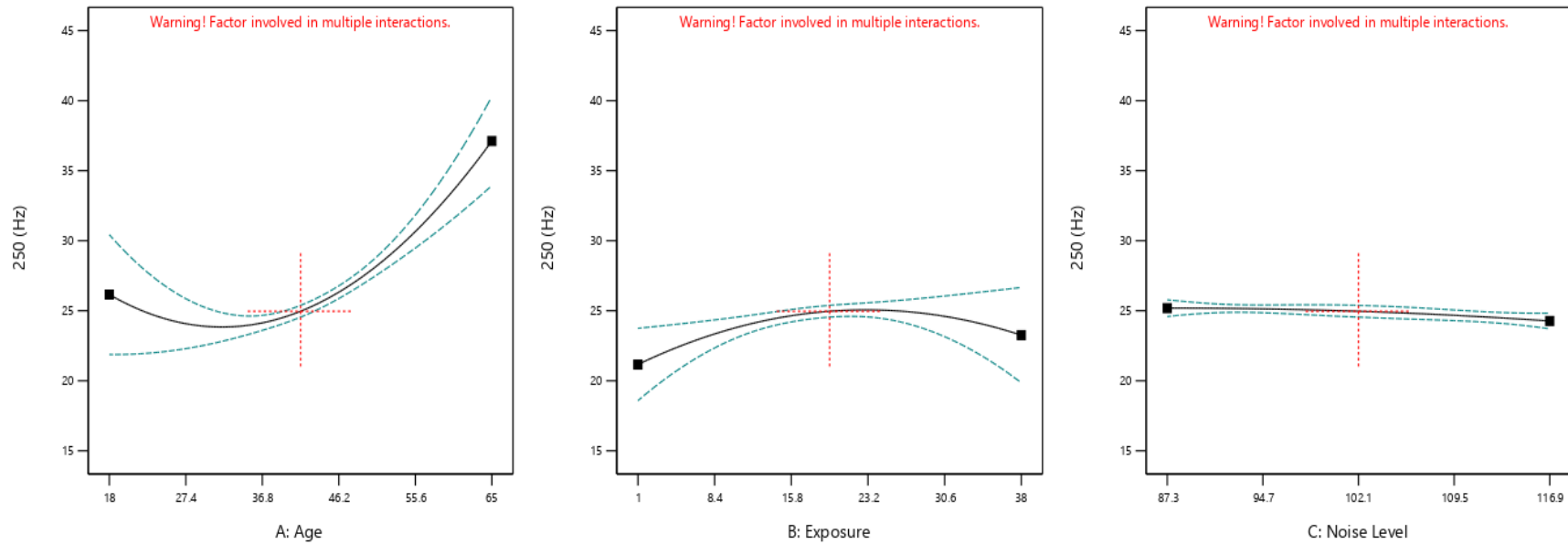
As shown in Figure 4.39, the hearing threshold increases with the age of the workers, year of exposure and the noise level. It can be deduced that as much as the quarry workers are exposed to the noisy workstations, the more they will have difficulty in their hearing system. The contour and 3D response surface plots which aid visualisation of variation for noise level and age interaction effect on hearing threshold are shown in Figure 4.40.

### **(C) Hearing threshold at frequency 1 kHz**

Figure 4.41, shows that the hearing threshold increases with the age of the workers, year of exposure and the noise level. Continuous exposure to the noise also increases the workers hearing threshold at this frequency. There was no observed significant factor interaction.

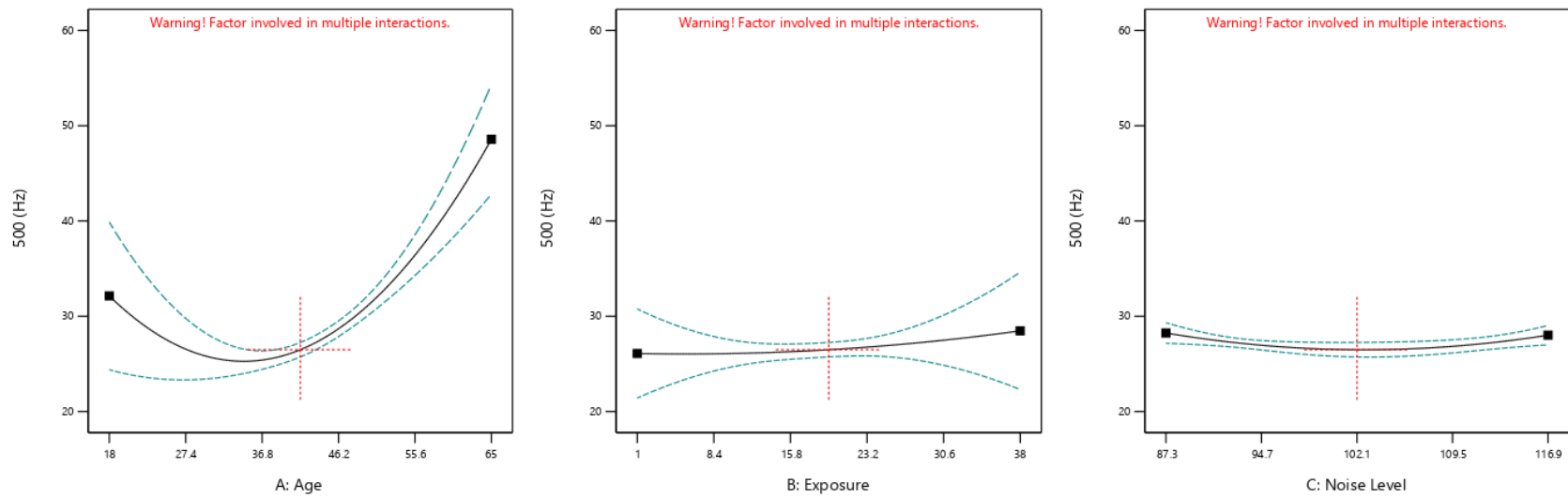
### **(D) Hearing threshold at frequency 2 kHz**

As shown in Figure 4.42, the hearing threshold increases with the age of the workers, year of exposure and the noise level. Continuous exposure to the noise also increases the workers hearing threshold at this frequency. There was no significant factors interaction.




**Figure 4.38: Effect of one factor on the hearing threshold at 250 Hz**



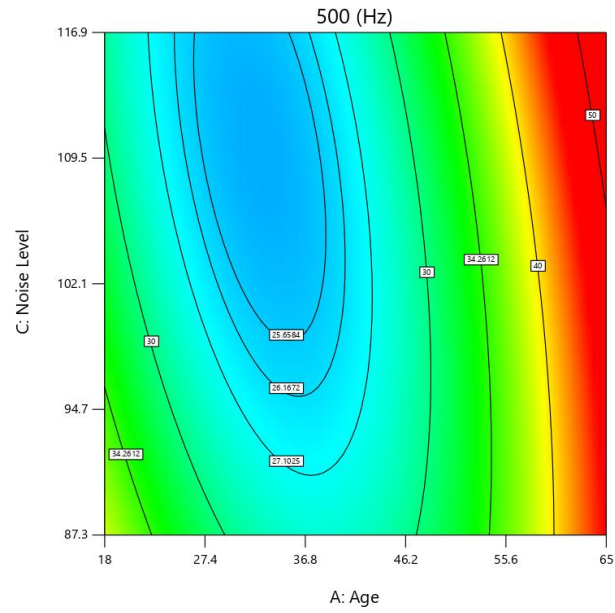


**Figure 4.39: Effect of one factor on the hearing threshold at 500 Hz**


Factor Coding: Actual

**500 (Hz)**  
20.651  45.663  
X1 = A  
X2 = C

**Actual Factor**  
B = 19.5



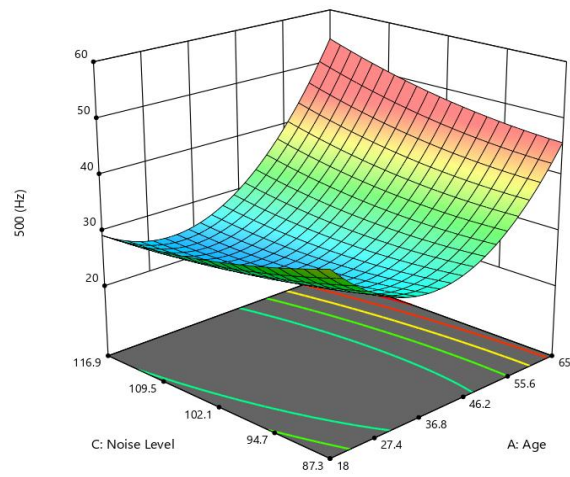
Factor Coding: Actual

**500 (Hz)**  
20.651  45.663

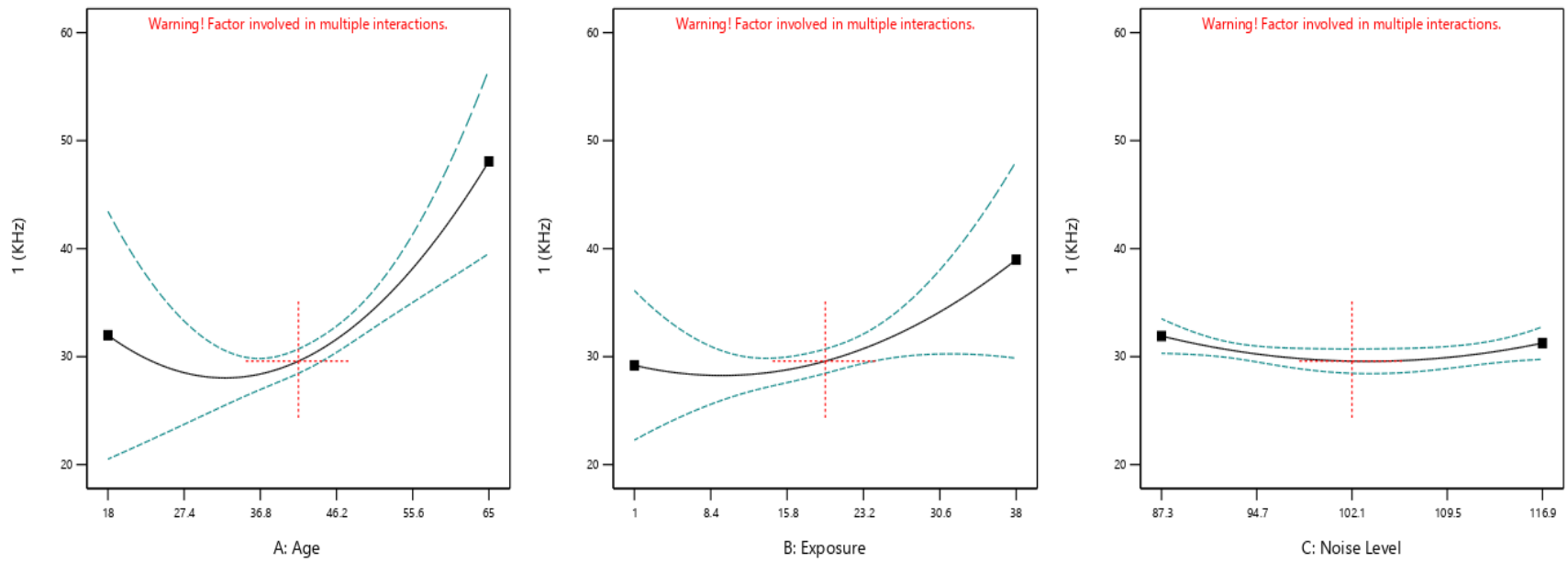
X1 = A  
X2 = C

**Actual Factor**  
B = 19.5

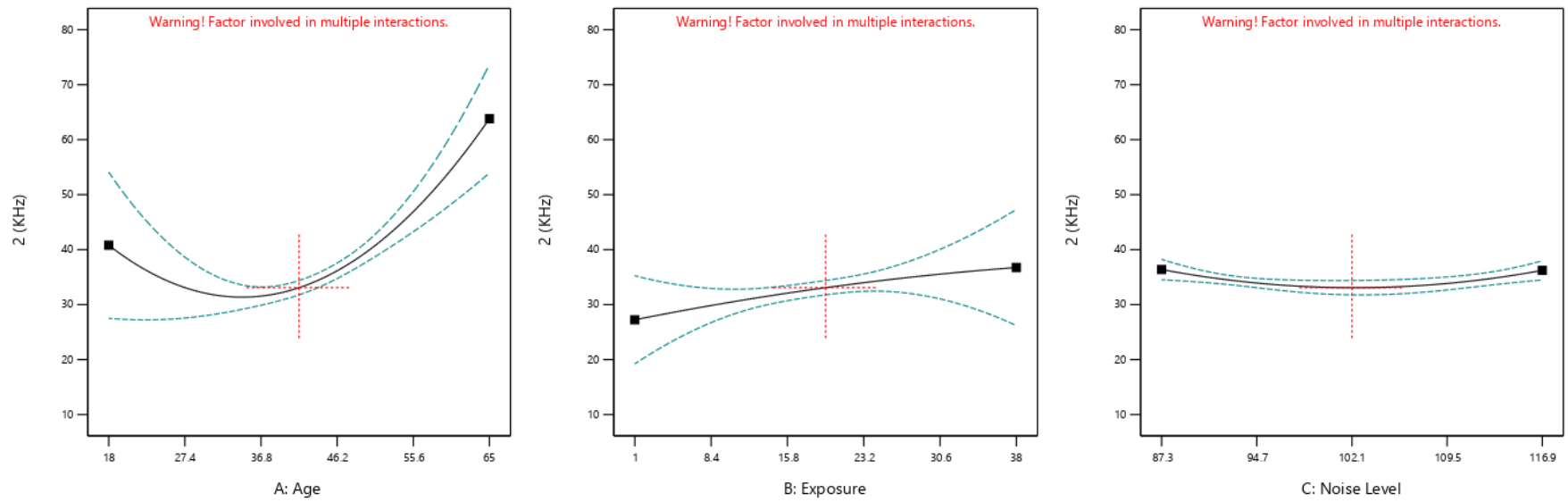
3D Surface



**Figure 4.40: Response surface plots of age and noise level on the hearing threshold at 500 Hz**



**Figure 4.41: Effect of one factor on the hearing threshold at 1 kHz**



**Figure 4.42: Effect of one factor on the hearing threshold at 2 kHz**

#### **(E) Hearing threshold at frequency 3 kHz**

As shown in Figure 4.43, the hearing threshold increases with the age of the workers and noise level, while decreasing as year of exposure increases. Since age is the most significant contributors to the hearing threshold according to the exhaustive search test, therefore the statement that hearing threshold decreases as years of exposure increases should be discarded. There is no significant factors interaction.

#### **(F) Hearing threshold at frequency 4 kHz**

As shown in Figure 4.44, the hearing threshold increases with the age of the workers and years of exposure while it decreases as the noise level increases. The statement involved noise level in this context should be discarded. The contour and 3D response surface plots which aid visualisation of variation for age and years of exposure interaction effect on hearing threshold were given in Figure 4.45.

#### **(G) Hearing threshold at frequency 6 kHz**

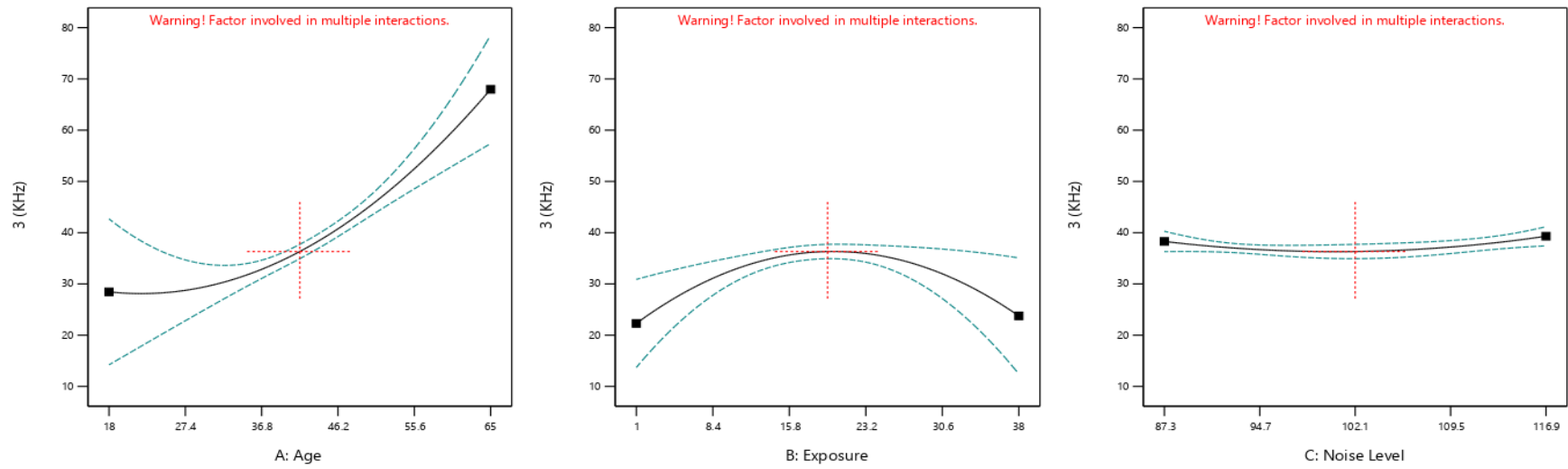
As shown in Figure 4.46, the hearing threshold increases with the age of the workers, year of exposure and the noise level. Continuous exposure to the noise also increases the workers hearing threshold at this frequency. There is no significant factors interaction.

#### **(H) Hearing threshold at frequency 8 kHz**

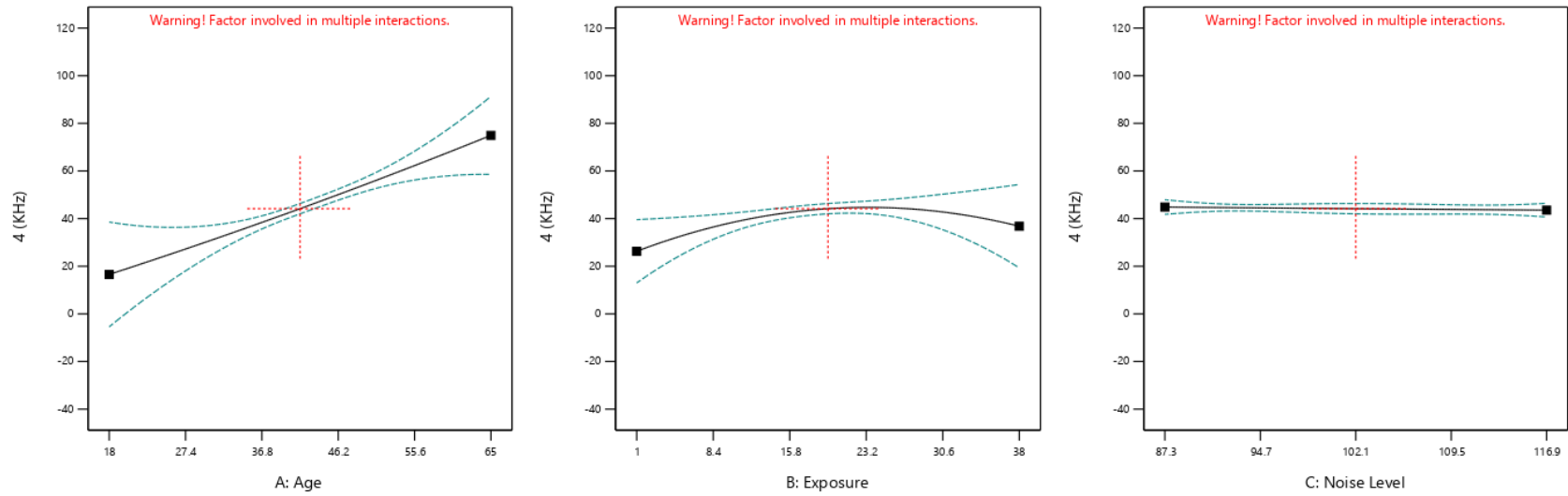
As shown in Figure 4.47, the hearing threshold increases with the age of the workers, year of exposure and the noise level. Continuous exposure to the noise also increases the workers hearing threshold at this frequency. There is no significant factors interaction.

### **4.9 Comparative statistics for hearing threshold of real and control experiments**

The control experimental group indicates how the models resulting from the experiments are able to explain the hearing thresholds of the subjects in different environments. In the control experimental groups (Appendix J) are subjects (workers) that were not exposed to high level noise in the production section of the quarries. In the real experimental groups are subjects that were exposed to high noise level in the production section of the quarry.




**Figure 4.43: Effect of one factor on the hearing threshold at 3 kHz**

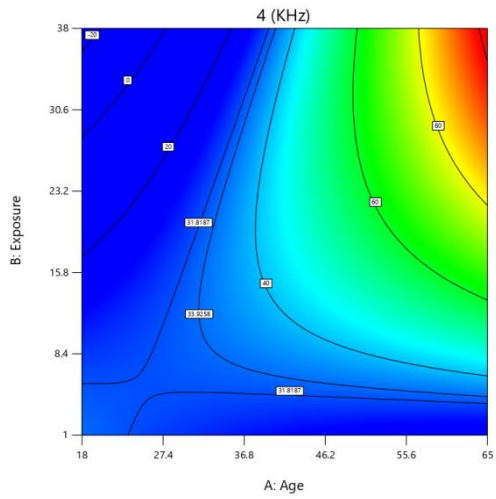


**Figure 4.44: Effect of one factor on the hearing threshold at 4 kHz**

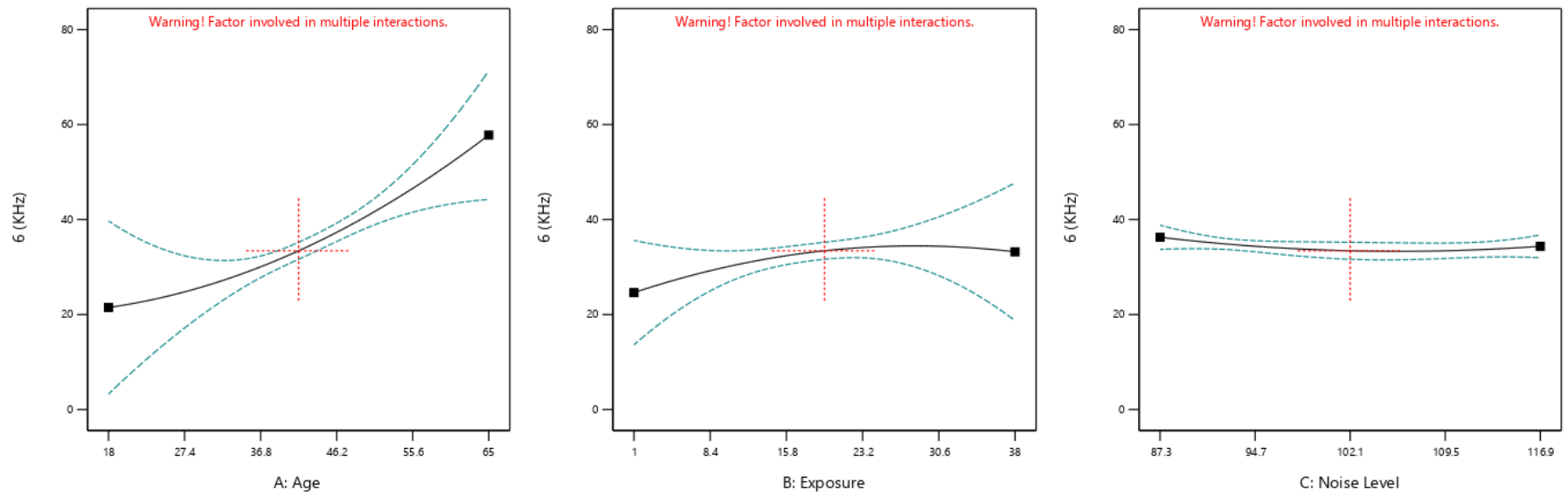
Factor Coding: Actual

**4 (KHz)**  
26.2  99.02  
X1 = A  
X2 = B

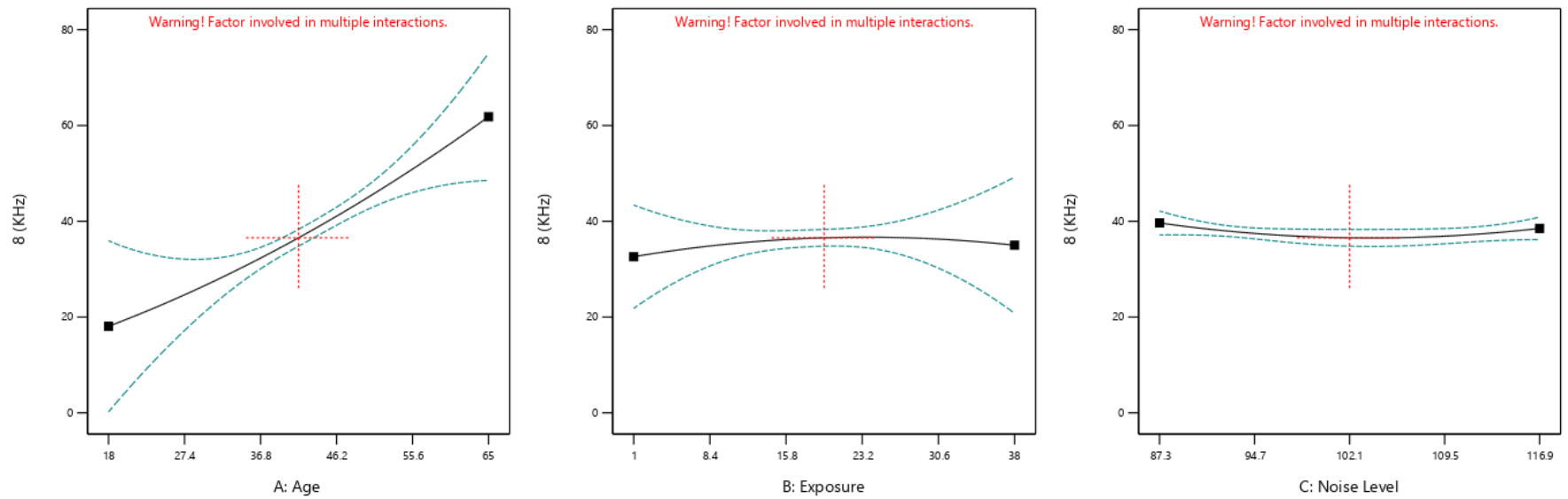
**Actual Factor**  
C = 102.1







**Figure 4.46: Effect of one factor on the hearing threshold at 6 kHz**



**Figure 4.47: Effect of one factor on the hearing threshold at 8 kHz**

Thus, the significant p-value and  $R^2$  as shown in Table 4.20 for the two groups suggest that, for each model, the age, years of exposure to noise and noise level are potent factors to account for the changes in the hearing threshold of workers that are exposed to noise and the workers that are not exposed to noise in the quarries.

In the real experiment, workers in this group exhibit higher hearing threshold levels than the workers in the control group. This also shows that there is occupational noise effect on the hearing threshold of workers in the noisy workstations.

#### **4.10 Robustness of the models**

The results of the models' validation exercises conducted in order to find out how well the models performed in making predictions, the model has to be validated. The outcomes of the two types of validation exercises performed internal validation (that is the adequacy of the models was verified), and external validation are here presented.

##### **4.10.1 Adequacy of the models**

The software (Expert Design, Version 6.0.8) itself compared the measured hearing threshold of all the categories of the quarry workers with the predicted values. The measured values were in agreement with the predicted values as presented in Appendix K. This is 'self-validation' mechanism of the software. This demonstrated that the response models were adequate.

##### **4.10.2 External validation of the models**

Apart from 'self-validation' mechanism inbuilt into the software, external validation of the models was performed. This was done by measuring the responses (hearing threshold) and the input variables (age, years of exposure and noise level) from different quarry workers that did not participate in activities that led to the development of the predictive models. The independent variables (age, years of exposure and noise level) were fed into the models using Microsoft Excel 2010 professional software. The measured values and the predicted values were in the same order as shown in Appendix L. This demonstrated that the response models were effective.

**Table 4.20: Summary of ANOVA for quadratic models and statistics for hearing threshold of real and control experiments**

| Frequency | Real Experiment             |         |                | Control Experiment          |         |                | <i>p</i> -value |
|-----------|-----------------------------|---------|----------------|-----------------------------|---------|----------------|-----------------|
|           | Mean Hearing Threshold (dB) | F-value | R <sup>2</sup> | Mean Hearing Threshold (dB) | F-value | R <sup>2</sup> |                 |
| 250Hz     | 25.20                       | 95.09   | 0.8302         | 22.82                       | 99.79   | 0.9656         | < 0.0001        |
| 500Hz     | 28.36                       | 70.21   | 0.7831         | 24.90                       | 81.48   | 0.9582         | < 0.0001        |
| 1kHz      | 31.72                       | 55.79   | 0.7415         | 27.00                       | 30.96   | 0.8970         | < 0.0001        |
| 2kHz      | 35.73                       | 66.83   | 0.7746         | 29.22                       | 30.61   | 0.8959         | < 0.0001        |
| 3kHz      | 38.81                       | 88.17   | 0.8193         | 31.34                       | 26.08   | 0.9726         | < 0.0001        |
| 4kHz      | 47.77                       | 106.30  | 0.8454         | 34.56                       | 69.16   | 0.9511         | < 0.0001        |
| 6kHz      | 36.70                       | 65.29   | 0.7705         | 27.85                       | 36.93   | 0.9122         | < 0.0001        |
| 8kHz      | 40.27                       | 73.01   | 0.7897         | 30.87                       | 33.41   | 0.9038         | < 0.0001        |

### **4.10.3 Predictive performance of the models**

R square and coefficient of variation (C.V.) are often used to assess the predictive performance of a regression model (Agha and Alnahhal, 2012). A high R square value and low C.V. (expressed as a percentage) are sought and desirable. According to Liyana-Pathirana and Shahidi (2005), high value of C.V. indicates that the ratio of root mean square error is very large relative to the mean of the dependent variable and thus, renders the model unreliable. In this study, eight models were developed and the Adjusted R squares for the models were ranging from 73 – 84% in all. Therefore C.V. < 10% has been suggested as appropriate for predictive models. In this study, the values of C.V. were less than 5.00% for all the models (Table 4.21), and the frequency 4 kHz have lowest of 2.56. Thus, it could be said that the models exhibit high predictive ability.

In general, all the models showed good predictive ability as can be noted in Tables 4.19. Seven of the models have Adjusted R squares value of over 75%. This shows that the models can be reliably used as predictive models.

### **4.11 Selection of values of age, years of exposure and noise level for the safe hearing threshold**

In order to find the values of age, years of exposure and noise level which can accommodate the safe hearing threshold values of 25 – 30dB for quarry workers, Table 4.22 show the response of the MATLAB interface of Design Expert 6.0.8 from the optimisation process of the variables combination for frequency 250 Hz – 8 kHz. The lower and upper limit of age (18- 65 years), years of exposure (1-38 years), Noise level (87.3-116.9dB) and hearing threshold range of 25-30dB as safe hearing threshold for the optimisation process. The summary of the results in Figures 4.48 - 4.55 are described in Table 4.22.

The running of this optimisation software produced the defaults of ramps view of the iteration and the best settings of combination of the 3 factors and the desirability of the predicted safe hearing threshold. The Ramp of optimisation results for the combinations of factors (age, years of exposure and noise level) for the safe hearing threshold at frequency 0.25 – 8 kHz are shown in Figures 4.48 – 4.55.

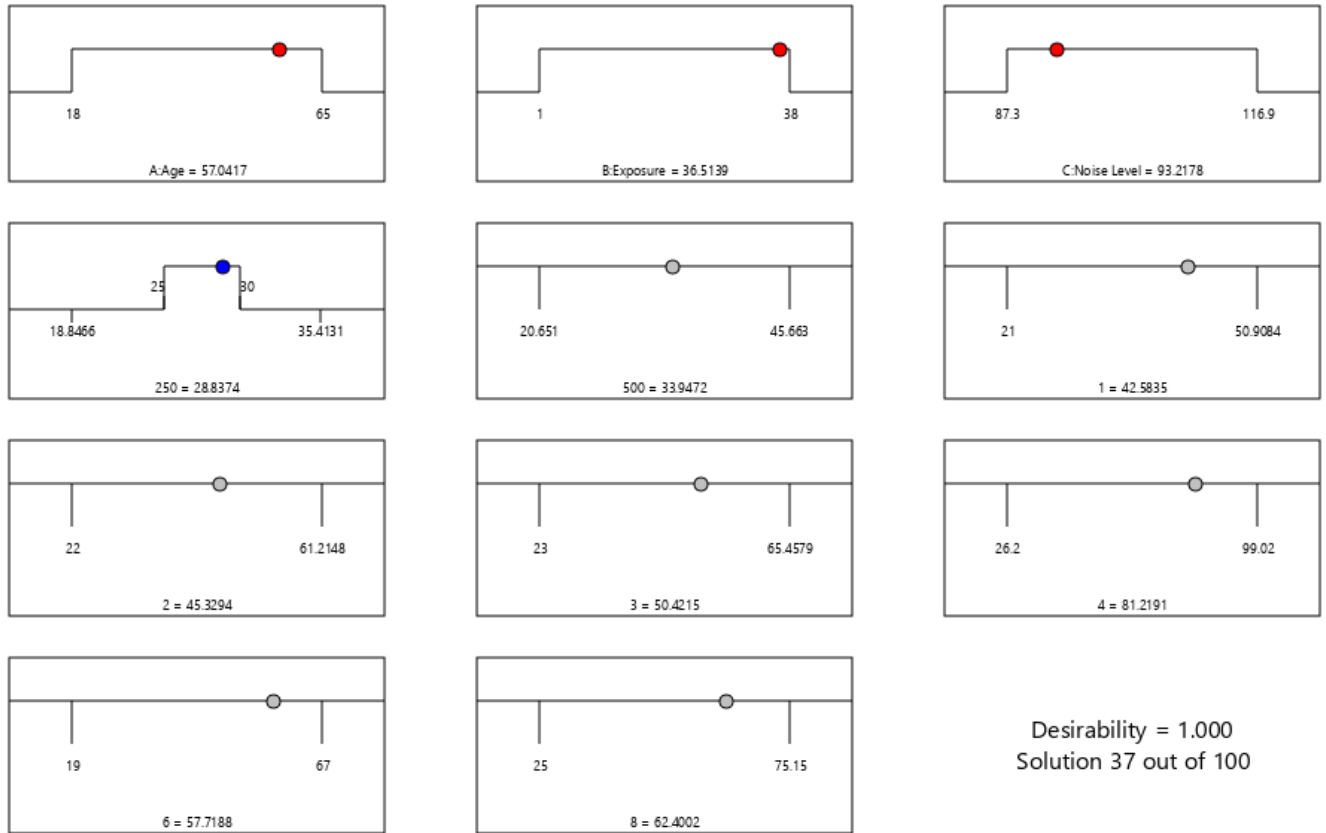
**Table 4.21: Summary of the statistics of the models across the frequency**

| <b>Response Model</b> | <b>Frequency</b> | <b>R<sup>2</sup></b> | <b>Adj. R<sup>2</sup></b> | <b>Pred. R<sup>2</sup></b> | <b>Adeq. Precision</b> | <b>C.V. (%)</b> |
|-----------------------|------------------|----------------------|---------------------------|----------------------------|------------------------|-----------------|
| 1                     | 250Hz            | 0.8302               | 0.8215                    | 0.8074                     | 50.4099                | 4.77            |
| 2                     | 500Hz            | 0.7831               | 0.7720                    | 0.7604                     | 44.4930                | 4.21            |
| 3                     | 1kHz             | 0.7415               | 0.7282                    | 0.7109                     | 35.8918                | 4.74            |
| 4                     | 2kHz             | 0.7746               | 0.7630                    | 0.7462                     | 42.705                 | 3.25            |
| 5                     | 3kHz             | 0.8193               | 0.8100                    | 0.7951                     | 44.8068                | 2.75            |
| 6                     | 4kHz             | 0.8454               | 0.8374                    | 0.8206                     | 50.3536                | 2.56            |
| 7                     | 6kHz             | 0.7705               | 0.7587                    | 0.7291                     | 38.8199                | 3.18            |
| 8                     | 8kHz             | 0.7897               | 0.7789                    | 0.7667                     | 40.2909                | 4.52            |

**Table 4.22: Optimization Response Output - Hearing Threshold at 250 Hz to 8 kHz**

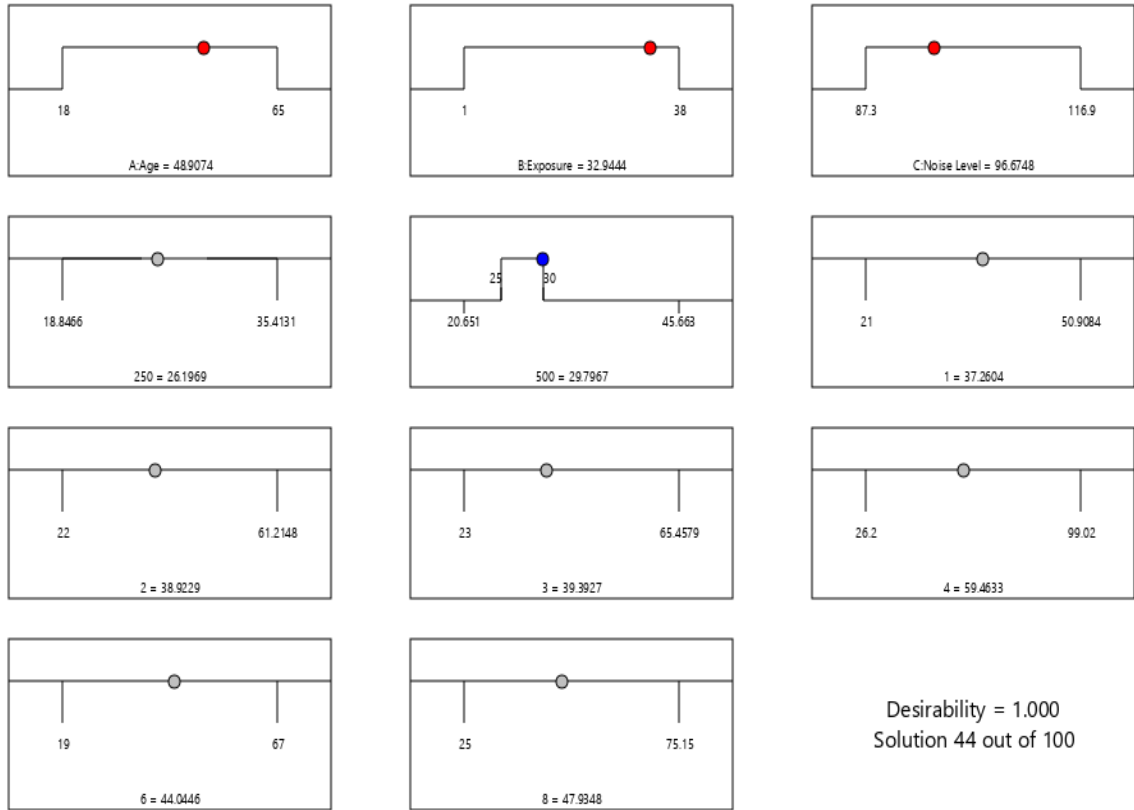
| <b>Factor</b>    | <b>Goal</b> | <b>Lower<br/>Limit</b> | <b>Upper<br/>Limit</b> | <b>Lower<br/>Weight</b> | <b>Upper<br/>Weight</b> | <b>Importance</b> |
|------------------|-------------|------------------------|------------------------|-------------------------|-------------------------|-------------------|
| A:Age            | is in range | 18                     | 65                     | 1                       | 1                       | 3                 |
| B:Exposure       | is in range | 1                      | 38                     | 1                       | 1                       | 3                 |
| C:Noise<br>Level | is in range | 87.3                   | 116.9                  | 1                       | 1                       | 3                 |
| 250              | is in range | 25                     | 30                     | 1                       | 1                       | 3                 |
| 500              | is in range | 25                     | 30                     | 1                       | 1                       | 3                 |
| 1                | is in range | 25                     | 30                     | 1                       | 1                       | 3                 |
| 2                | is in range | 25                     | 30                     | 1                       | 1                       | 3                 |
| 3                | is in range | 25                     | 30                     | 1                       | 1                       | 3                 |
| 4                | is in range | 25                     | 30                     | 1                       | 1                       | 3                 |
| 6                | is in range | 25                     | 30                     | 1                       | 1                       | 3                 |
| 8                | is in range | 25                     | 30                     | 1                       | 1                       | 3                 |

Range is between 25 and 30dB

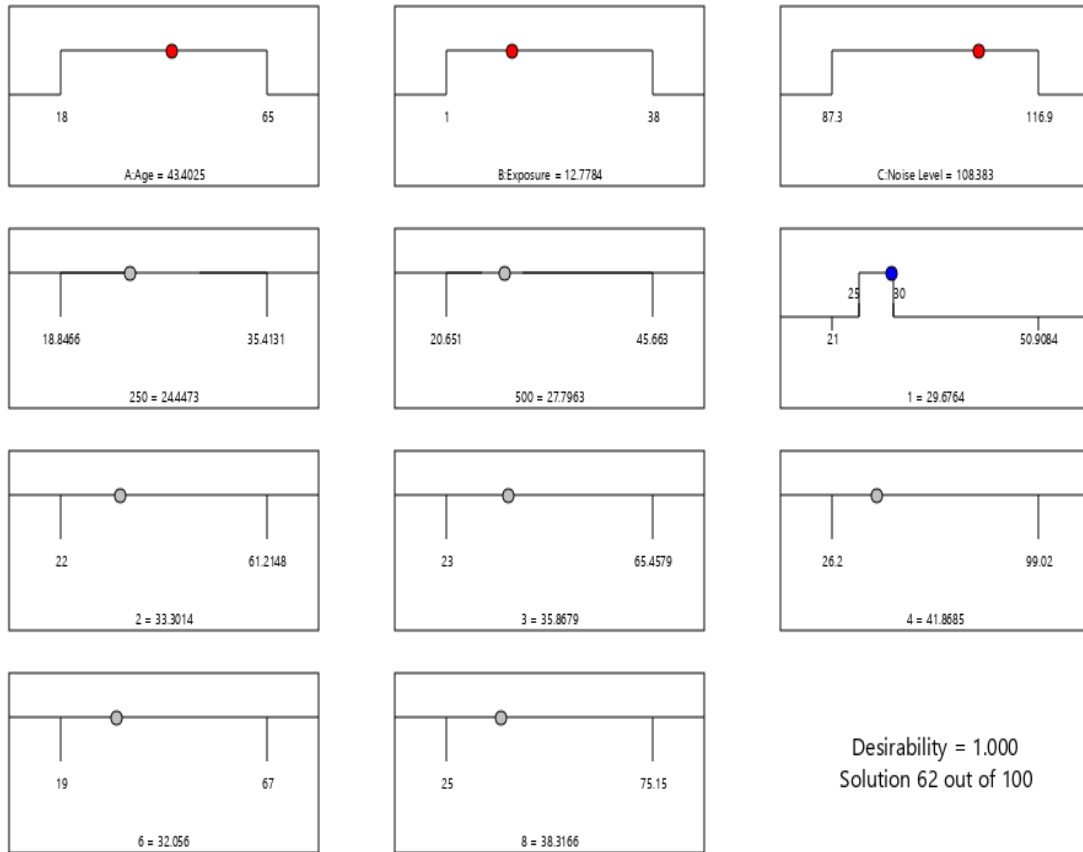


**Figure 4.48: Ramp of optimization result for hearing threshold at 250 Hz**

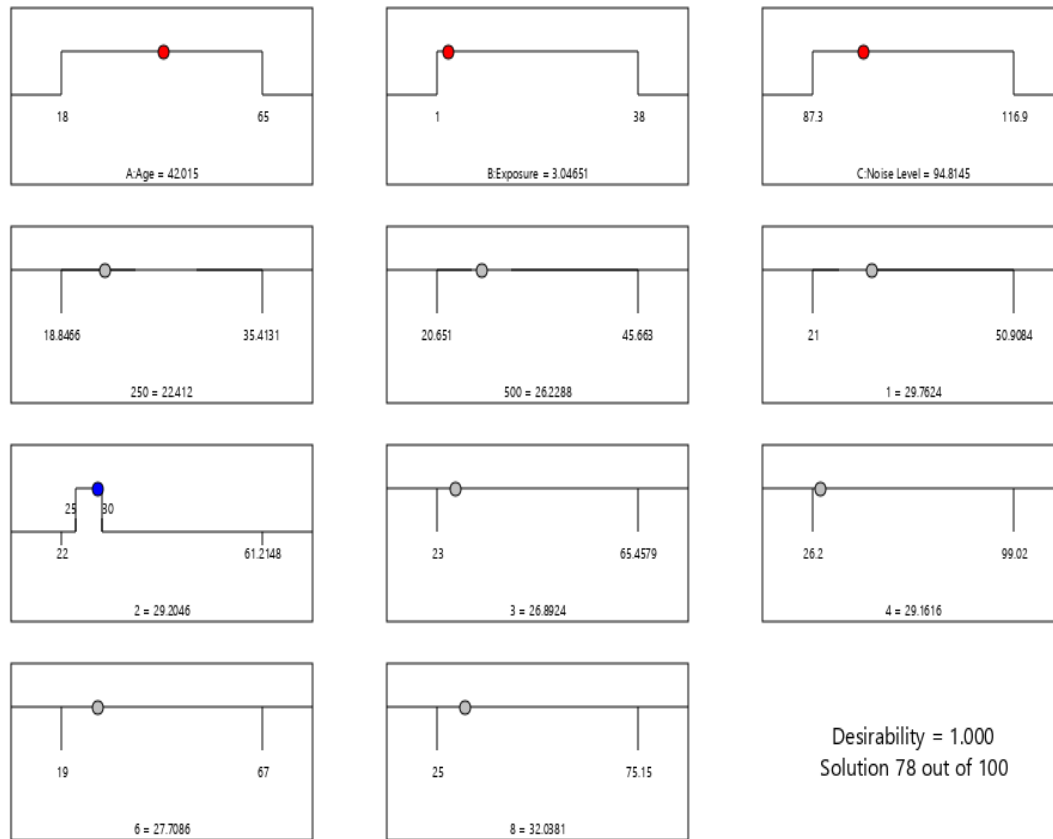




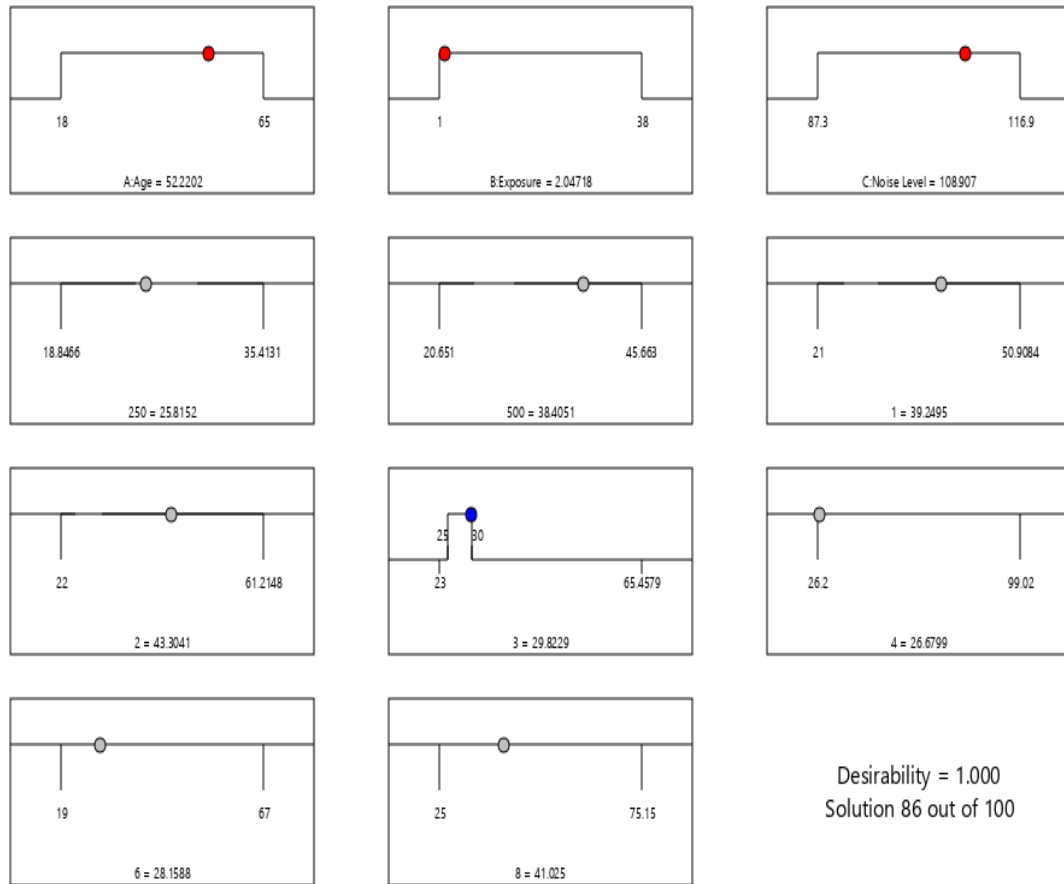
**Figure 4.49: Ramp of optimisation result for hearing threshold at 500 Hz**



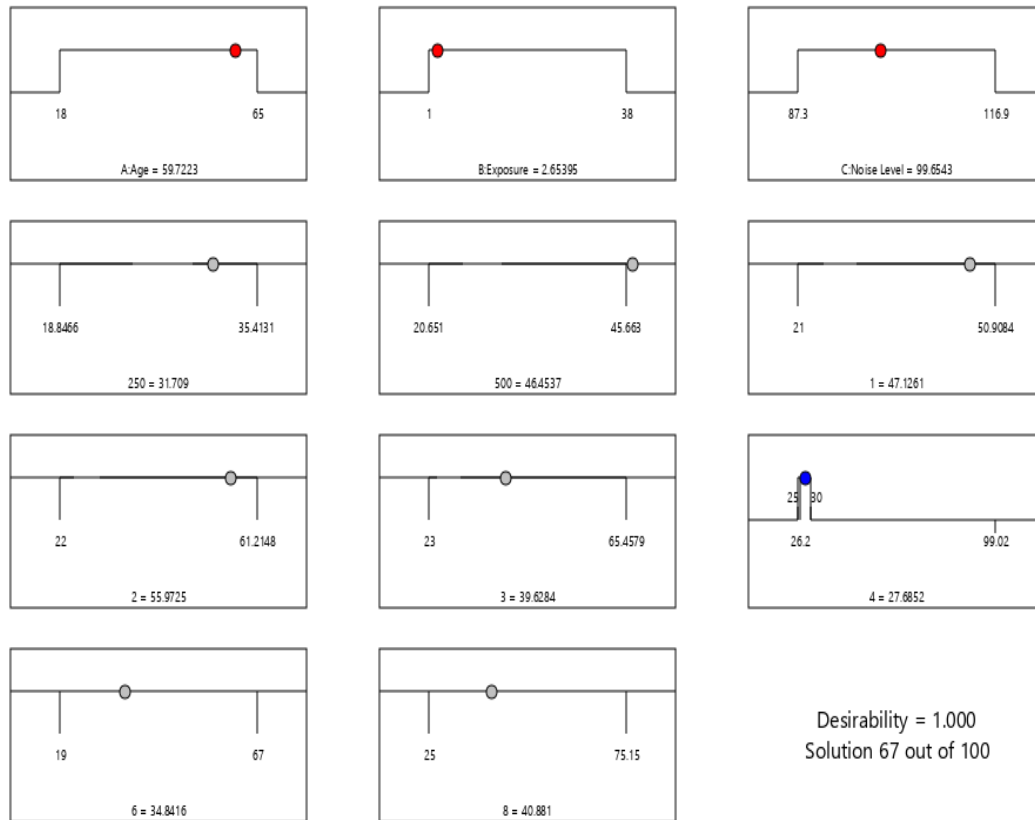
**Figure 4.50: Ramp of optimisation result for hearing threshold at 1 kHz**



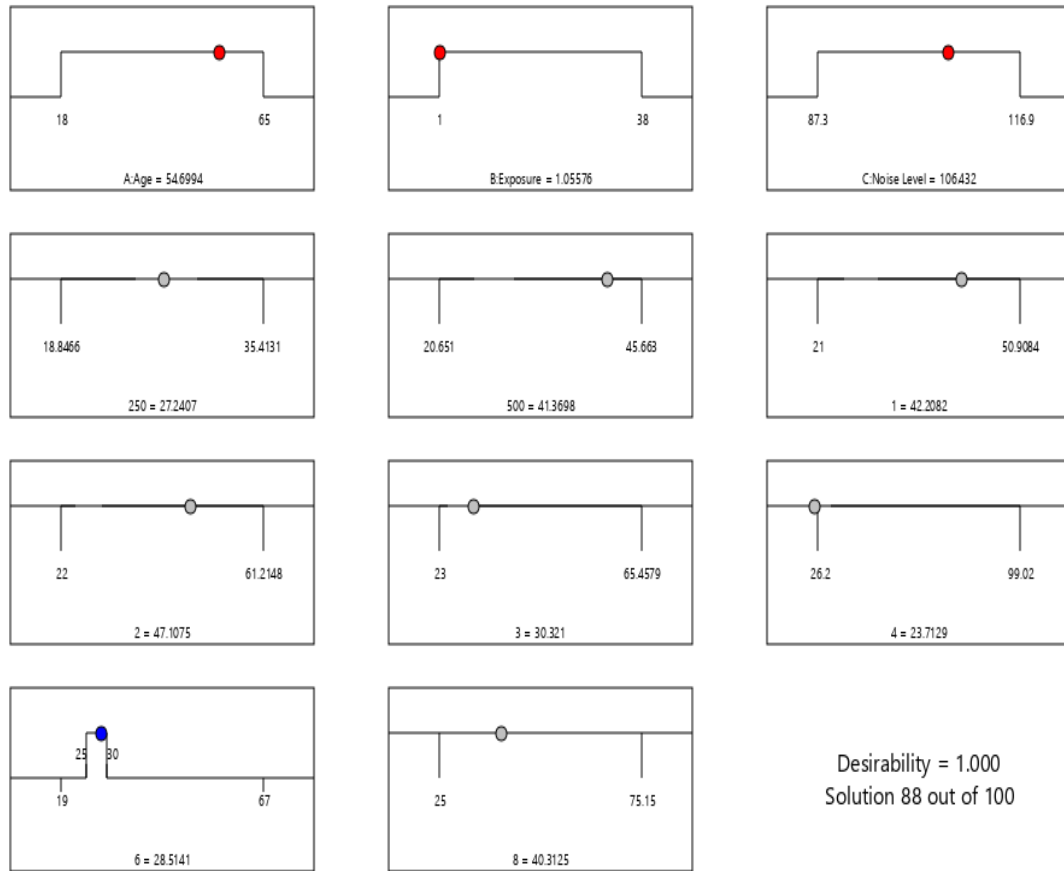
**Figure 4.51: Ramp of optimisation result for hearing threshold at 2 kHz**



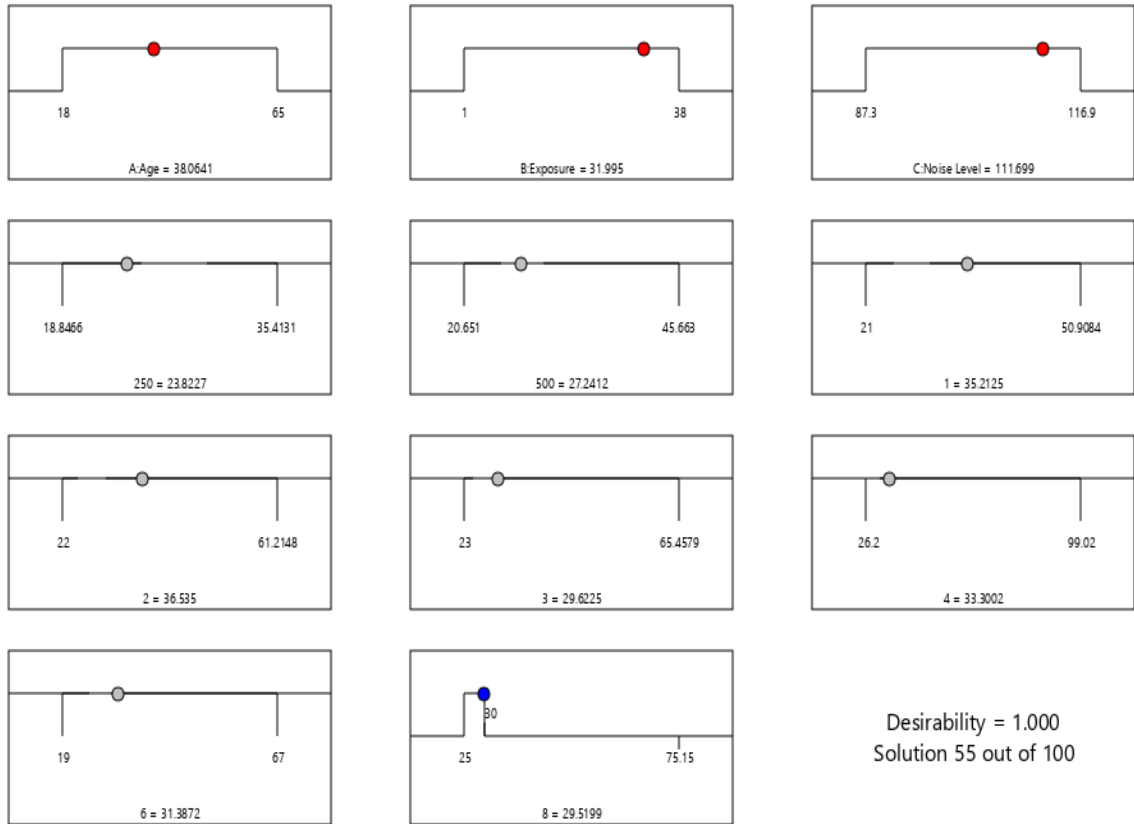
**Figure 4.52: Ramp of optimisation result for hearing threshold at 3 kHz**



**Figure 4.53: Ramp of optimisation result for hearing threshold at 4 kHz**



**Figure 4.54: Ramp of optimisation result for hearing threshold at 6 kHz**



**Figure 4.55: Ramp of optimisation result for hearing threshold at 8 kHz**

#### **4.12 Age, Years of Exposure and Noise Level that can Accommodate Safe Hearing Threshold**

Design Expert 6.0.8 was used to find the values of factors which can produce the safe hearing threshold of the quarry workers. The combinations of the parameters were subjected to optimisation process of MATLAB interface of Design Expert 6.0.8 at each frequency of 250 Hz, 500 Hz, 1 kHz, 2 kHz, 3 kHz, 4 kHz, 6 kHz and 8 kHz. The only feasible factors combination from the optimisation ramp results (figure 4.55) is at frequency 8 kHz with age, years of exposure and noise level are 38 years, 32 years and 111.7 dB respectively.

Age was uncovered as the major determinant in predicting hearing threshold of quarry workers. Therefore, when conducting the optimisation experiment, using the Design Expert Software 6.0.8 for the analysis, the safe design points for age, years of exposure and noise level is 38 years, 32 years and 111.7dB respectively (Table 4.23).

The study recommendation for the point of entry to quarry work is 18 years. By the time the quarry worker of age 38 years had 32 years of exposure; the worker must have started the job at the age of (38-18) years, which was 20 years then. In this vein, by the time the worker of 20 years of age have 32 years of noise exposure in the quarry, he must have attained (20+32) years of age. Therefore, the optimal age and years of exposure for the quarry worker in service will be 52 years or less; with 32 years or less respectively. The workers at the production section in the quarry will have safe hearing threshold till the age of 52 years or less (Appendix M). Such workers working at production section should be regularly rotated in less noisy workstation areas to reduce the noise exposure duration.

Therefore, if a quarry worker must maintain between the range of 25-30dB of safe hearing threshold, the age of the workers should be 52 years or less, with 32 years or less working exposure in the quarry; in order to enhance these condition, hearing protective device should not be left out.

Thus, the expression as shown in equation (4.9) can be used to explain the relationship between the present age of the worker in the quarry and the optimal year of exposure to the noise.

$$(X - 18) + Y \leq 52 \quad (4.9)$$



**Table 4.23: Summary of the values of age, years of exposure and noise level at 250 Hz-8 kHz for safe hearing threshold values of 25-30 dB**

| <b>Frequency</b> | <b>Age (Years)</b> | <b>Exposure (Years)</b> | <b>Noise level (dB)</b> |
|------------------|--------------------|-------------------------|-------------------------|
| 250Hz            | 57                 | 36.5                    | 93.2                    |
| 500Hz            | 49                 | 33                      | 96.7                    |
| 1kHz             | 43                 | 13                      | 108.4                   |
| 2kHz             | 42                 | 3                       | 94.8                    |
| 3kHz             | 52                 | 2                       | 108.9                   |
| 4kHz             | 60                 | 3                       | 99.7                    |
| 6kHz             | 55                 | 1.05                    | 106.4                   |
| 8kHz             | 38*                | 32*                     | 111.7*                  |

\*Safe values

Where,

X represents the present age of the workers and Y represent the optimal years of exposure to the noise.

#### **4.13 Effects of Age, Years of Exposure and Noise Level on Hearing Threshold over Time**

Paired sample Pearson correlation, Coefficient of mean difference and paired sample T-test were conducted in order to determine the effects of age, years of exposure and noise level on hearing threshold over the time (Appendix N).

##### **4.13.1 Paired Sample Pearson Correlation Coefficient of Mean Difference Between Hearing Threshold at different Frequencies**

Table 4.24 shows the significant correlations between hearing loss in the first year of measurement and second year of measurement at all frequencies. The significant Pearson correlation coefficients indicated that hearing threshold suffered by the quarry workers in the first year is a significant baseline for hearing threshold in the second year. Thus, a quarry worker who has an increased in hearing threshold in the second year when compared with the first year measurement also indicated that as the age of the workers increase, there is an increase in hearing threshold. The correlation coefficient (0.795) is highest under the frequency 4 kHz and lowest (0.166) under frequency 6 kHz.

##### **4.13.2 Paired Sample Statistics of the First and Second Year of Mean Hearing Threshold of the Respondents at different Frequencies**

Table 4.25 shows the paired sample statistics of the first and second year of mean hearing threshold of the subjects at all frequencies. For each frequency, the mean hearing threshold in the second year was observed to be higher than the mean hearing threshold in the first year of measurement with the same subjects. This is an indication that the hearing threshold has worsened during the one year interval.

**Table 4.24: Paired sample Pearson correlation coefficient of mean differences between hearing threshold in the first year and second year of measurement at various frequencies**

|        |   |             |     | Correlation | Sig.  |
|--------|---|-------------|-----|-------------|-------|
| Pair 1 | Hearing_Threshold_250Hz                   | after 1year | and | 0.436       | 0.00* |
|        | Hearing_Threshold_250Hz in the base year. |             |     |             |       |
| Pair 2 | Hearing_Threshold_500Hz                   | after 1year | and | 0.821       | 0.00* |
|        | Hearing_Threshold_500Hz in the base year. |             |     |             |       |
| Pair 3 | Hearing_Threshold_1kHz                    | after 1year | and | 0.770       | 0.00* |
|        | Hearing_Threshold_1kHz in the base year.  |             |     |             |       |
| Pair 4 | Hearing_Threshold_2kHz                    | after 1year | and | 0.742       | 0.00* |
|        | Hearing_Threshold_2kHz in the base year.  |             |     |             |       |
| Pair 5 | Hearing_Threshold_3kHz                    | after 1year | and | 0.705       | 0.00* |
|        | Hearing_Threshold_3kHz in the base year.  |             |     |             |       |
| Pair 6 | Hearing_Threshold_4kHz                    | after 1year | and | 0.795       | 0.00* |
|        | Hearing_Threshold_4kHz in the base year.  |             |     |             |       |
| Pair 7 | Hearing_Threshold_6kHz                    | after 1year | and | 0.166       | 0.02* |
|        | Hearing_Threshold_6kHz in the base year.  |             |     |             |       |
| Pair 8 | Hearing_Threshold_8kHz                    | after 1year | and | 0.664       | 0.00* |
|        | Hearing_Threshold_8kHz in the base year.  |             |     |             |       |

**N = 185; \*Significant at  $p < 0.05$**

**Table 4.25: Paired sample statistics of mean hearing threshold of the respondents in the first and second year at various frequencies**

|        |                            | <b>Mean</b> | <b>Std. Deviation</b> | <b>Std. Error Mean</b> |
|--------|----------------------------|-------------|-----------------------|------------------------|
| Pair 1 | HT_250Hz after 1yr         | 27.59       | 4.381                 | 0.317                  |
|        | HT_250Hz in the base year. | 24.23       | 7.870                 | 0.569                  |
| Pair 2 | HT_500Hz after 1yr         | 31.79       | 5.662                 | 0.410                  |
|        | HT_500Hz in the base year. | 27.09       | 5.051                 | 0.365                  |
| Pair 3 | HT_1kHz after 1yr          | 36.93       | 6.559                 | 0.475                  |
|        | HT_1kHz in the base year.  | 30.32       | 6.587                 | 0.477                  |
| Pair 4 | HT_2kHz after 1yr          | 42.71       | 7.564                 | 0.547                  |
|        | HT_2kHz in the base year.  | 33.64       | 8.307                 | 0.601                  |
| Pair 5 | HT_3kHz after 1yr          | 50.07       | 9.222                 | 0.667                  |
|        | HT_3kHz in the base year.  | 37.66       | 9.973                 | 0.722                  |
| Pair 6 | HT_4kHz after 1yr          | 65.02       | 13.979                | 1.012                  |
|        | HT_4kHz in the base year.  | 46.49       | 15.544                | 1.125                  |
| Pair 7 | HT_6kHz after 1yr          | 45.94       | 12.610                | 0.912                  |
|        | HT_6kHz in the base year.  | 36.59       | 12.157                | 0.880                  |
| Pair 8 | HT_8kHz after 1yr          | 48.72       | 12.139                | 0.878                  |
|        | HT_8kHz in the base year.  | 39.23       | 11.839                | 0.857                  |

**HT: Hearing Threshold; N = 185**

#### **4.13.3 Paired Sample t test for Differences in the Hearing Threshold in the First and Second year**

Table 4.26 displays the results of Paired Sample t test for differences in the hearing threshold in the first and second years. The t values for all differences under the frequencies are significant. Hence, the hypothesis that there are no significant differences, that is differences are zeros, in the average hearing threshold in the first year of measurement and second year of measurement is negated. There are differences in the hearing threshold exhibited by the same quarry workers in the first year and second year and these differences are not due to a mere statistical chance; they are due to real effect of factors that continuously contribute to hearing threshold. The differences are due to higher hearing threshold exhibited by the workers in the second year.

#### **4.14 Results of Ergonomic Evaluation of Hearing Threshold Predictors**

From the foregoing analysis, the following hypothesis are accepted or rejected:

**H<sub>0</sub>:** Age of workers, years of exposure and noise level cannot significantly predict hearing threshold of workers.

**H<sub>1</sub>:** Age of workers, years of exposure and noise level significantly predict hearing threshold of the workers.

**Decision rule:** Accept H<sub>0</sub> if  $p\text{-value} > \alpha (=0.05)$  or reject H<sub>0</sub> if  $p\text{-value} < 0.05$ .

##### **Frequency 250 Hz**

**Decision:** Age of the workers ( $p\text{-value} < 0.0001$ ) and noise level ( $p\text{-value} 0.0029$ ) of the workers are significant.

**Conclusion:** Age of the workers and noise level can significantly predict hearing threshold of workers at frequency 250 Hz.

##### **Frequency 500 Hz**

**Decision:** Age has  $p\text{-value} < 0.0001$ , the interaction of age and noise level ( $p\text{-value} 0.0012$ ) of the workers is significant.

**Conclusion:** Age of workers, the interaction of age and noise level significantly predict hearing threshold of the workers at frequency 500 Hz.

**Table 4.26: Paired sample t - test for differences in the hearing threshold in the first and second year**

|        |   | Paired differences |                 |   |        |        | T      | df  | Sig.   |
|--------|---|--------------------|-----------------|---|--------|--------|--------|-----|--------|
|        |   | Std. Deviation     | Std. Error Mean | 95% Confidence Interval of the Difference |        |        |        |     |        |
|        |   |                    |                 | Lower                                     | Upper  |        |        |     |        |
| Pair   | Description                               |                    |                 |   |        |        |        |     |        |
| Pair 1 | Hearing Threshold_250 Hz after 1year      | 3.361              | 7.147           | 0.517                                     | 2.341  | 4.381  | 6.500  | 184 | 0.000* |
|        | Hearing Threshold_250 Hz in the base year |                    |                 |   |        |        |        |     |        |
| Pair 2 | Hearing Threshold_500 Hz after 1year      | 4.696              | 3.256           | 0.236                                     | 4.232  | 5.161  | 19.933 | 184 | 0.000* |
|        | Hearing Threshold_500 Hz in the base year |                    |                 |   |        |        |        |     |        |
| Pair 3 | Hearing Threshold_1 kHz after 1year       | 6.613              | 4.458           | 0.323                                     | 5.976  | 7.249  | 20.502 | 184 | 0.000* |
|        | Hearing Threshold_1 kHz in the base year  |                    |                 |   |        |        |        |     |        |
| Pair 4 | Hearing Threshold_2 kHz after 1year       | 9.063              | 5.738           | 0.415                                     | 8.244  | 9.882  | 21.829 | 184 | 0.000* |
|        | Hearing Threshold_2 kHz in the base year  |                    |                 |   |        |        |        |     |        |
| Pair 5 | Hearing Threshold_3 kHz after 1year       | 12.403             | 7.409           | 0.536                                     | 11.346 | 13.461 | 23.136 | 184 | 0.000* |
|        | Hearing Threshold_3 kHz in the base year  |                    |                 |   |        |        |        |     |        |
| Pair 6 | Hearing Threshold_4 kHz after 1year       | 18.524             | 9.575           | 0.693                                     | 17.157 | 19.890 | 26.738 | 184 | 0.000* |
|        | Hearing Threshold_4 kHz in the base year  |                    |                 |   |        |        |        |     |        |
| Pair 7 | Hearing Threshold_6 kHz after 1year       | 9.351              | 15.996          | 1.157                                     | 7.068  | 11.634 | 8.079  | 184 | 0.000* |
|        | Hearing Threshold_6 kHz in the base year  |                    |                 |   |        |        |        |     |        |
| Pair 8 | Hearing Threshold_8 kHz after 1year       | 9.492              | 9.832           | 0.711                                     | 8.089  | 10.895 | 13.342 | 184 | 0.000* |
|        | Hearing Threshold_8 kHz in the base year  |                    |                 |   |        |        |        |     |        |

**N = 185; \*Significant at  $p < 0.05$**

### **Frequency 1 kHz**

**Decision:** Age of the workers ( $p$ -value  $<0.0001$ ) and years of exposure ( $p$  – value 0.0019) are significant.

**Conclusion:** Age of the workers and years of exposure significantly predict hearing threshold of workers at frequency 1 kHz.

### **Frequency 2 kHz**

**Decision:** Age of the workers ( $p$ -value  $< 0.0001$ ); and years of exposure ( $p$  – value 0.0090) are significant.

**Conclusion:** Age and years of exposure significantly predict hearing threshold of workers at frequency 2 kHz.

### **Frequency 3 kHz**

**Decision:** Age ( $p$  – value  $< 0.0001$ ) is significant.

**Conclusion:** Age of the workers significantly predict hearing threshold of workers at frequency 3 kHz.

### **Frequency 4 kHz**

**Decision:** Age ( $p$  – value  $< 0.0001$ ); interaction of age and years of exposure ( $p$  –value 0.0143) are significant.

**Conclusion:** Age; and interaction of age and years of exposure of the workers significantly predict hearing threshold of workers at frequency 4 kHz.

### **Frequency 6 kHz**

**Decision:** Age of the workers ( $p$  – value  $<0.0001$ ) is significant.

**Conclusion:** Only Age of the workers can significantly predict the hearing threshold of workers at frequency 6 kHz.

### **Frequency 8 kHz**

**Decision:** Age of the workers ( $p$  – value  $<0.001$ ) is significant.

**Conclusion:** Only Age of the workers can significantly predict the hearing threshold of workers at frequency 8 kHz.

It can be seen that only age of the quarry workers predict hearing threshold at all frequencies between 250 Hz to Frequency 8 kHz.

## **4.15 Discussion of Results**

This present study investigated the physiological response of quarry workers working in noisy environment. Results are as follows:

### **4.15.1 Noise Magnitude of the Machinery used in Quarry Operation**

The amount of noise emitted by various equipment which workers were exposed to during work in selected quarries were measured. The noise measurement values in this study 28.4 dBA in the administrative section, and range of 87.3 dBA to 116.98 dBA in the production section.

The quarry workers exhibited a mean hearing threshold value of 45.6 dB, 75% had hearing threshold level higher than 25 dBA. The differences between the mean values of hearing threshold level of the respondents of the four quarries were not significant ( $F=1.068$ ,  $p = 0.364$ ) which indicated that all the quarries workers were subjected to about the same working conditions and environmental noise (Appendix I).

### **4.15.2 Predictive Models**

The developed 8 predictive models at various frequencies show that:

#### **(A) Frequency 250 Hz**

Age of workers and noise level can independently significantly predict the quarries worker hearing threshold at this frequency. The entire diagnostic test proved the appropriateness of the model. Hearing threshold increases with the age of the workers, while decreasing with the years of exposure and the noise level.

#### **(B) Frequency 500 Hz**

Age of workers and noise level; and the interaction of age and noise level can significantly predict the hearing threshold of quarry workers at this frequency. Models were appropriate for the prediction.

#### **(C) Frequency 1 kHz**

Age and years of exposure can significantly predict the hearing threshold of quarry workers at frequency 1 kHz. The entire diagnostic test proved the model as reliable one.



#### **(D) Frequency 2 kHz**

Age of workers and years of exposure can significantly predict the hearing threshold of quarry workers at frequency 1 kHz. A reliable model was established. The entire diagnostic test proved the model as reliable one.

#### **(E) Frequency 3 kHz**

Age of workers only can significantly predict the hearing threshold of the quarry workers at his frequency. A reliable model was established. The entire diagnostic test proved the model as reliable one.

#### **(F) Frequency 4 kHz**

Age of workers and years of exposure; and the interaction of age and years of exposure significantly predicted the hearing threshold of the quarry workers at this frequency. A reliable model was established. The entire diagnostic test proved the model as reliable.

#### **(G) Frequency 6 kHz**

Only Age of the workers can predict the hearing threshold of the quarry workers at this frequency. A reliable model was established. The entire diagnostic test proved the model as reliable one.

#### **(H) Frequency 8 kHz**

Age of workers only significantly predicted the hearing threshold of the quarry workers at this frequency. Models were appropriate for the prediction.

Conclusively, the models obtained showed that age of workers can predict the hearing threshold across all frequencies, while years of exposure can predict the hearing threshold at 1 kHz, 2 kHz and 4 kHz only, and noise level can predict the hearing threshold at the frequency 250 Hz and 500 Hz.

#### **4.15.3 Combination of values of age, years of exposure and noise level that produce safe hearing threshold**

Based on the data collected and used in this work, for a quarry worker to maintain the safe hearing threshold of 25-30 dB in the quarry, the optimal age of the workers should be 52 years or less, with working exposure of 32 years or less. This implies that older workers

above 52 years should not be subjected to the high noise level zone in the quarry for too long. Their operation could be alternated with other area where noise intensity is not high.

#### **4.15.4 Effects of Age, Years of Exposure and Noise Level with Hearing Threshold over Time at Different Frequencies**

The results of paired sample correlation shows that a quarry worker with a high hearing threshold in the first year also had an increased hearing threshold in the second year with the highest correlation coefficient 0.795 at frequency 4 kHz and lowest 0.166 at frequency 6 kHz (Table 4.24). More so, paired sample statistics of mean difference between hearing threshold in the first and second year of experiment indicated that at each frequency, the mean hearing threshold in the second year was greater than the mean hearing threshold in the first year (Table 4.25). It can be concluded that the hearing threshold has worsened during the one year. Also, paired samples t-test for differences in the hearing threshold in the first and second year at all frequencies are significant. Hence there are differences in the hearing threshold exhibited by the quarry workers in the first and second year (Table 4.26). The differences were due to a higher hearing threshold exhibited by the workers in the second year; which was due to real effect of factors that continuously contributes to hearing threshold.

## **CHAPTER FIVE**

### **SUMMARY, CONCLUSION AND RECOMMENDATIONS**

#### **5.1 Summary**

This study was conducted to develop suitable models to determine the synergistic influence of age, years of exposure and noise level on the hearing threshold of workers. Two hundred and four and one hundred and eighty five workers from the same initial 204 subjects from four different four quarries volunteered for audiometry tests in 2018 and 2019 respectively. The multifactor effect of the factors as they influence hearing threshold was analysed using Adaptive Neural-Fuzzy Inference System (ANFIS) and regression analysis at eight different hearing frequencies between 0.25 and 8.00 kHz.

#### **5.2 Conclusion**

The following conclusions were drawn based on the activities undertaken in the study,:

1. The equipment used in quarry operations produce 87.3 - 116.9 dBA noise level which was greater than the acceptable threshold sound level; except in the administrative section where the noise level was 28.4 dBA.
2. The differences between the noise levels in the administrative block and quarry sections are due to the greater exposure of the workers at quarry section to high noise level and hence the higher hearing threshold than the administrative workers.
3. The eight hearing threshold predictive models of the quarry workers between the studied frequencies models showed good predictive capability and models satisfactorily.
4. Thus, having known the parameters of the 3 main factors effects aforementioned, the hearing threshold of a worker at various frequencies can be determined.
5. The safe settings of the studied factors (age of workers, years of exposure and noise level) that can accommodate relatively safe hearing threshold at various frequencies were found obtained as 52 years, 32 years of exposure and optimal noise level of 112 dB will ensure the safe hearing threshold of 25-30 dB at 8 working hours of exposure.

6. The hearing threshold of workers between the baseline year and the second year; continuously worsened.

7. Thus having known the age of the workers, years of exposure of the workers and the noise level of the workstation, the quarry workers employee can find these findings useful when recruiting workers in order to ensure a safe working environment for the worker's hearing status.

### **5.3 Recommendations**

(i) Further research can consider the effect of other indices such as race of the workers' medical history, quarry equipment age, maintenance practices and individual biological tolerance for noise.

(ii) More longitudinal years of experimental period like 5 years may be embraced.

(iii) Further study can consider other locations and compare the performance of the models to the ones presented in this study.

(iv) Further research is needed in workstation with noise of higher frequencies apart from those investigated in this work.

(v) This type of study should be carried out on quarry workers in order to compare workers that embraced the usage of PPE and others which did not.

(vi) Consideration of some workers life style like smoking, alcohol consumption, chemicals and dust exposure can be considered in the future study.

### **5.4 Contributions to Knowledge**

1. This study established that the hearing threshold of the quarry workers can be determined when the age, years of exposure and noise level which they are exposed to are known. Thus, the three parameters are the useful input variable for predictive models for design purposes for the workstations.

2. Furthermore, the study presented eight models for the prediction, which can aid the selection of fit workers to a safe workstation.

3. The audiogram of the quarry workers can be determined by using the developed models, the stress and rigour that may ensue would be ameliorated or completely eliminated.

4. This study also enhances the safe utilisation of manpower. A safe and healthy workstation for workers can be determined when the age of the workers; years of exposure and noise level are known as well as applying engineering control in attenuating the high noise exposure usually emanated from the quarry.

5. The data collected in this research work were limited to those needed for Ergonomic design for the quarry workstation. The data may be suitable for the design of other noisy workstation, hence similar studies which will collect complete and comprehensive ergonomic data across the country are recommended. This will serve as database for the quarry workers in general.

6. The models presented in this study can be reliably used to create database for the ergonomic design of the quarry workers.

## REFERENCES

- Abbasi, B. and Mahlooji, H. 2012. Improving response surface methodology by using artificial neural network and simulated annealing. *Expert Systems with Applications* 39. 3: 3461-3468. doi:<https://doi.org/10.1016/j.eswa.2011.09.036>
- Abdulkadir, S. J., Alhussian, H., Nazmi, M. and Elsheikh, A. A. 2018. Long Short Term Memory Recurrent Network for Standard and Poor's 500 Index Modelling. *International Journal of Engineering & Technology* 7. 4: 25-29. doi:<https://doi.org/10.14419/ijet.v7i4.15.21365>
- Acoustical Surfaces. 2013. Top 10 Noisiest Jobs. Retrieved 28 February, 2023 <https://www.acousticalsurfaces.com/blog/acoustics-education/top-10-noisiest-jobs/>
- Adeniyi, A. 2021. Job absorption capacity of Nigeria's mining and quarrying sector. *Journal of Business Administration Research* 10. 1: 51-61.
- Agha, S.R. and Alnahhal, M. 2012. Neural network and multiple linear regression to predict school children dimensions from Ergonomic school furniture design. *Applied Ergonomics*.43(6): 979-984. DOI: 10.1016/j.apergo.2012.01.007.
- Ahmed, H. O., Dennis, J. H., Badran, O., Ismail, M., Ballal, S. G., Ashoor, A. and Jerwood, D. 2001. High-frequency (10-18 kHz) hearing thresholds: reliability, and effects of age and occupational noise exposure. *Occup Med (Lond)* 51. 4: 245-258. doi:10.1093/occmmed/51.4.245
- Akanbi, O. G., Oriolowo, K.T., Oladejo, K. A., Abu, R., Mogbojuri, A.O. and Ogunlana, R. 2021. Models for Estimating the Hearing Threshold of Quarry Workers at High Frequencies. *Nigerian Journal of Environmental Sciences and Technology* 5: 140-151. doi:10.36263/nijest.2021.01.0254
- Akanbi, O. G. and Oriolowo, K. T. 2016. Modeling the prevention of transformation of presbycusis to noise induced hearing loss. *Journal of Business Administration Research Nigerian Institute of Industrial Engineers (NIIE)*. 6: 47-58.
- Akinluyi, F. O., Awoniran, D. R., Oladejo, S. O. and Ogunniyi, O. S. 2019. Environmental evaluation of quarry operation in Akure metropolis, Ondo state, Nigeria *Ethiopian Journal of Environmental Studies & Management* 12. 2: 229-237. doi:<https://ejesm.org/doi/v12i2.10>
- Al-Maghrabi, M.N. N., Shewakh, W. M. and Haleem, A. 2013. Degradation of industrial performance due to environmental factors "impact of noise on mining and manufacturing workers". *International Journal of Mechanical and Production Engineering Research and Development* 3. 2: 147-154.
- Allen, P. D. and Eddins, D. A. 2010. Presbycusis phenotypes form a heterogeneous continuum when ordered by degree and configuration of hearing loss. *Hear Res* 264. 1-2: 10-20. doi:10.1016/j.heares.2010.02.001

- Aluclu, I., Dalgic, A. and Toprak, Z. F. 2008. A fuzzy logic-based model for noise control at industrial workplaces. *Appl Ergon* 39. 3: 368-378. doi:10.1016/j.apergo.2007.08.005
- Amedofu, G. K. 2002. Hearing-impairment among workers in a surface gold mining company in Ghana. *Afr J Health Sci* 9. 1-2: 91-97. doi:10.4314/ajhs.v9i1.30759
- Amirian, M. (2019). *Mitigating sub-synchronous resonance using static var compensator (SVC) enhanced with adaptive neuro-fuzzy inference systems (ANFIS) controller*. Paper presented at the Proceedings of 27th Iranian Conference on Electrical Engineering (ICEE), Iran.
- Anastasiadou, S. and Al Khalili, Y. 2022. Hearing Loss. Retrieved 3 June, 2022, from StatPearls Publishing <https://www.ncbi.nlm.nih.gov/books/NBK542323/>
- ANSI (2004). Methods for manual pure-tone-threshold audiometry (ANSI S3.21-2004). New York.
- Aremu, M. O., Oke, E. O., Arinkoola, A. O. and Salam, K. K. 2014. Development of optimum operating parameters for bioelectricity generation from sugar wastewater using response surface methodology. *Journal of Scientific Research & Reports* 3. 15: 2098-2109.
- Asfahl, C. R. 2004. *Industrial Safety and Health Management*: Prentice Hall.
- ASHA, 1990. American Speech-Language-Hearing-Association. Guidelines for manual pure tone threshold audiometry. Retrieved from [www.asha.org/policy](http://www.asha.org/policy) Jan. 07, 2021.
- ASHA, 2004. American Speech-Language-Hearing-Association. Guidelines for manual pure tone threshold audiometry. Retrieved from [www.asha.org/policy](http://www.asha.org/policy) Feb. 11, 2022.
- Aslan, Z., Erdemir, G., Feoli, E., Giorgi, F. and Okcu, D. 2019. Effects of Climate Change on Soil Erosion Risk Assessed by Clustering and Artificial Neural Network. *Pure and Applied Geophysics* 176. 2: 937-949. doi:10.1007/s00024-018-2010-y
- Asmara, Y. 2013. The Use of Response Surface Methodology to Predict CO2 Corrosion Model Empirically.
- Awolu, O., Oloniyo, R. and Ayodele, B. S. 2013. Optimization of solvent extraction of oil from neem (*Azadirachta indica*) and its characterizations. *Journal of Scientific Research & Reports* 2. 1: 304-314.
- Bainbridge, K. E. and Wallhagen, M. I. 2014. Hearing loss in an aging American population: extent, impact, and management. *Annu Rev Public Health* 35: 139-152. doi:10.1146/annurev-publhealth-032013-182510

- Barati-Harooni, A., Najafi-Marghmaleki, A. and Mohammadi, A. H. 2016. ANFIS modeling of ionic liquids densities. *Journal of Molecular Liquids* 224: 965-975. doi:<https://doi.org/10.1016/j.molliq.2016.10.050>
- Basner, M., Babisch, W., Davis, A., Brink, M., Clark, C., Janssen, S. and Stansfeld, S. 2014. Auditory and non-auditory effects of noise on health. *Lancet* 383. 9925: 1325-1332. doi:10.1016/s0140-6736(13)61613-x
- Bisong, S. A., Umana, A. N., Onoyom-Ita, V. and Osim, E. E. 2004. Hearing acuity loss of operators of food grinding machines in Calabar, Nigeria. *Nigerian Journal of Physiological Sciences* 19. 1-2: 20-27. doi:10.4314/njps.v19i1.32631
- Boateng, C. A. and Amedofu, G. K. 2004. Industrial noise pollution and its effects on the hearing capabilities of workers: a study from sawmills, printing presses and corn mills. *African Journal of Health Sciences* 11.1: 524-530.
- Bobadilla, M., Lostado-Lorza, R., Escribano-Garcia, R., Somovilla Gómez, F. and Vergara, E. 2017. An Improvement in Biodiesel Production from Waste Cooking Oil by Applying Thought Multi-Response Surface Methodology Using Desirability Functions. *Energies* 10: 130. doi:10.3390/en10010130
- Boman, E., Enmarker, I. and Hygge, S. 2005. Strength of noise effects on memory as a function of noise source and age. *Noise Health* 7. 27: 11-26. doi:10.4103/1463-1741.31636
- Bonissone, P. P. 2002. Adaptive Neural Fuzzy Inference System (ANFIS): Analysis and Applications. Retrieved 8 June, 2022 <https://www.scribd.com/document/21954114/Adaptive-Neural-Fuzzy-Inference-Systems-ANFIS-Analysis-and-Applications>
- Bouloiz, H., Garbolino, E. and Tkiouat, M. 2013. Modeling of an Organizational Environment by System Dynamics and Fuzzy Logic. *Open Journal of Safety Science and Technology Vol.03No.04*: 9. doi:10.4236/ojsst.2013.34012
- Burtka, C. and Chick, K. 1997. *Non –Industrial Noise levels*. San Diego: London Singular Publishing group Inc. .
- Caponetto, R., Lavorgna, M., Martinez, A. and Occhipinti, L. (1997, 21-23 May 1997). *GAs for fuzzy modeling of noise pollution*. Paper presented at the Proceedings of 1st International Conference on Conventional and Knowledge Based Intelligent Electronic Systems. KES '97.
- Civelekoglu, G., Perendeci, A., Yigit, N. O. and Kitis, M. 2007. Modeling Carbon and Nitrogen removal in an industrial wastewater treatment plant using an adaptive network-based fuzzy inference system. *Clean* 35. 6: 617– 625. doi:10.1002/clen.200700076



- Correia, A. W., Peters, J. L., Levy, J. I., Melly, S. and Dominici, F. 2019. Residential exposure to aircraft noise and hospital admissions for cardiovascular diseases: multi-airport retrospective study. *BMJ : British Medical Journal* 347: f5561. doi:10.1136/bmj.f5561
- Cunningham, L. L. and Tucci, D. L. 2017. Hearing Loss in Adults. *N Engl J Med* 377. 25: 2465-2473. doi:10.1056/NEJMra1616601
- Derringer, G. C. and Suich, R. C. 1980. Simultaneous Optimization of Several Response Variables. *Journal of Quality Technology* 12: 214-219.
- Do, B., Robinet, S., Praudeau, D. and Guoyon, F. 2001. Application of central composite design for optimisation of the chromatographic separation of monomethylarsonate and dimethylarsinate and of selenomethiomine and selenite by ion-pair chromatography coupled with plasma mass spectrometric detection. *Analyst* 12.6:594-601.
- Dua, D., and Taniskidou, E.K. 2017. UCI Machine learning repository. University of California, school of information and computer science, Irvine, CA. Retrieved July 20, 2021, from <http://archive.ics.uci.edu/ml>.
- Diniz, F. M. and Martin, A. M. 1996. Use of response surface methodology to describe the combined effect of Ph temperature and E/S ratio on the hydrolysis of Dogfish (*Squalus Acanthias*) muscle. *International Journal of Food Science and Technology* 31. 5: 419-426. doi:<https://doi.org/10.1046/j.1365-2621.1996.00351.x>
- El-Tayeb, N. S. M., Yap, T. C. and Brevern, P. 2010. Wear characteristics of titanium alloy Ti54 for cryogenic sliding applications. *Tribology International* 43: 2345-2354.
- England, B. and Larsen, J. B. 2014. Noise levels among spectators at an intercollegiate sporting event. *Am J Audiol* 23. 1: 71-78. doi:10.1044/1059-0889(2013/12-0071)
- Ferilla, F., Mazziotti, D., Celso, G., Michelis, I., Stanici, V., and Veglis, F. 2010. Optimisation of the transesterification reaction in biodiesel production. *Fuel* 89. 1: 36-42.
- Fernandez, F. J., Seco, A., Ferrer, J. and Rodrigo, M. A. 2009. Use of neurofuzzy networks to improve wastewater flow-rate forecasting. *Environmental Modelling & Software* 24. 6: 686-693. doi:<https://doi.org/10.1016/j.envsoft.2008.10.010>
- Fink, D. 2019. A new definition of noise. *Acoustical Society of America* 39. 05002: 1-12. doi:10.1121/2.0001186
- Gharakhani, M., Alizadeh, M., Fotoohi, E. and Rada, R. 2011. Design and analysis of experiments in ANFIS modeling for stock price prediction. *EtInternational Journal of Industrial Engineering Computations* 2. 2: 409-418. doi:10.5267/j.ijiec.2011.01.001

- Gheisari, M., Wang, G. and Bhuiyan, M. Z. A. 2017. *A survey on deep learning in big data*. Paper presented at the international conference on computational science and engineering (CSE) and IEEE international conference on embedded and ubiquitous computing (EUC). Conference paper. July 2017. DOI: 10.1109/CSE-EUC.2017.215.
- Gómez, F. S., Lorza, R. L., Bobadilla, M. C. and García, R. E. 2017. Improving the Process of Adjusting the Parameters of Finite Element Models of Healthy Human Intervertebral Discs by the Multi-Response Surface Method. *Materials (Basel) 10*. 10. doi:10.3390/ma10101116
- Government of Alberta. 2009. Workplace Health and Safety: Noise at the worksite. Retrieved 3 June, 2022, from Government of Alberta, Employment and Immigration <https://open.alberta.ca/publications/hs003-hearing-sight>
- Gyamfi, C. K., Amankwaa, I., Owusu Sekyere, F. and Boateng, D. 2016. Noise Exposure and Hearing Capabilities of Quarry Workers in Ghana: A Cross-Sectional Study. *J Environ Public Health 2016*: 7054276. doi:10.1155/2016/7054276
- He, S., Smargiassi, A., Low, N., Bilodeau-Bertrand, M., Ayoub, A. and Auger, N. 2019. Residential noise exposure and the longitudinal risk of hospitalization for depression after pregnancy: Postpartum and beyond. *Environmental Research 170*: 26-32. doi:<https://doi.org/10.1016/j.envres.2018.12.001>
- Healthy hearing.com. 2020. Understanding the degrees of hearing loss and hearing loss levels. Retrieved Jan. 3, 2022, from <https://www.healthyhearing.com/report/41775-Degrees-of-hearing-loss>.
- Hoffman, H. J., Dobie, R. A., Losonczy, K. G., Themann, C. L. and Flamme, G. A. 2017. Declining Prevalence of Hearing Loss in US Adults Aged 20 to 69 Years. *JAMA Otolaryngol Head Neck Surg 143*. 3: 274-285. doi:10.1001/jamaoto.2016.3527
- Holman, J. A., Drummond, A., Hughes, S. E. and Naylor, G. 2019. Hearing impairment and daily-life fatigue: a qualitative study. *International Journal of Audiology 58*. 7: 408-416. doi:10.1080/14992027.2019.1597284
- Huiping, L., Guoqun, Z., Shanting, N. and Yiguo, L. 2007. Technologic parameter optimization of gas quenching process using response surface method. *Computational Materials Science 38*. 4: 561-570. doi:<https://doi.org/10.1016/j.commatsci.2006.03.014>
- Humes, L. E. 2019. The World Health Organization's hearing-impairment grading system: an evaluation for unaided communication in age-related hearing loss. *Int J Audiol 58*. 1: 12-20. doi:10.1080/14992027.2018.1518598
- Ighalo, J. O., Adelodun, A., Adeniyi, A. and Igwegbe, C. 2020. Modelling the Effect of Sorbate-Sorbent Interphase on the Adsorption of Pesticides and Herbicides by Historical Data Design. *Iranica Journal of Energy & Environment 11*: 253-259. doi:10.5829/ijee.2020.11.04.02

- Ilse, M., Tomczak, J. M. and Welling, M. 2020. Chapter 22 - Deep multiple instance learning for digital histopathology. In S. K. Zhou, D. Rueckert, & G. Fichtinger (Eds.), *Handbook of Medical Image Computing and Computer Assisted Intervention* (pp. 521-546) Academic Press.
- Industrial Accident Prevention Association. 2008. Hearing conservation. Retrieved 19 September, 2013, from Industrial Accident Prevention Association [www.iapa.ca.2hearing](http://www.iapa.ca.2hearing)
- Ismail, A. F., Daud, A., Ismail, Z. and Abdullah, B. 2013. Noise-induced hearing loss among quarry workers in a north-eastern state of malaysia: a study on knowledge, attitude and practice. *Oman Med J* 28. 5: 331-336. doi:10.5001/omj.2013.96
- Jang, J. S. R. 1993. ANFIS: adaptive-network-based fuzzy inference system. *IEEE Transactions on Systems, Man, and Cybernetics* 23. 3: 665-685. doi:10.1109/21.256541
- Jeirani, Z., Mohamed Jan, B., Si Ali, B., Noor, I. M., See, C. H. and Saphanuchart, W. 2013. Prediction of the optimum aqueous phase composition of a triglyceride microemulsion using response surface methodology. *Journal of Industrial and Engineering Chemistry* 19. 4: 1304-1309. doi:<https://doi.org/10.1016/j.jiec.2012.12.032>
- Johnson, J. 2023. Types of machinery in the quarry industry. Retrieved 28 February, 2023 <https://smallbusiness.chron.com/types-machinery-quarry-industry-55491.html>
- Kamil, R. J. and Lin, F. R. 2015. The effects of hearing impairment in older adults on communication partners: a systematic review. *J Am Acad Audiol* 26. 2: 155-182. doi:10.3766/jaaa.26.2.6
- Kansedo, J., Lee, K.T., and Bhatia, S., 2009. Biodiesel production from palm oil via heterogeneous transesterification. *Biomass Bioenergy* 33.2: 271-276.
- Karaboga, D. and Kaya, E. 2016. An adaptive and hybrid artificial bee colony algorithm (ABC) for ANFIS training. *Applied Soft Computing* 49: 423-436. doi:<https://doi.org/10.1016/j.asoc.2016.07.039>
- Karaboga, D. and Kaya, E. 2019. Adaptive network based fuzzy inference system (ANFIS) training approaches: a comprehensive survey. *Artificial Intelligence Review* 52. 4: 2263-2293. doi:10.1007/s10462-017-9610-2
- Kerketta, S., Gartia, R. and Bagh, S. 2012a. Assessment of Noise Induced Hearing Loss of the Mine Workers of a Chromite Mines at Sukinda, Orissa, India. *Noise & Vibration Worldwide* 43. 2: 28-36. doi:10.1260/0957-4565.43.2.28
- Kerketta, S., Gartia, R. and Bagh, S. 2012b. Hearing Threshold, Loss, Noise Levels and Worker's Profiles of an Open Cast Chromite Mines in Odisha, India. *Malays J Med Sci* 19. 4: 63-71.

- Kisi, O., Shiri, J., Karimi, S. and Adnan, R. M. 2018. Three Different Adaptive Neuro Fuzzy Computing Techniques for Forecasting Long-Period Daily Streamflows. In S. S. Roy, P. Samui, R. Deo, & S. Ntalampiras (Eds.), *Big Data in Engineering Applications* (pp. 303-321). Singapore Springer Singapore.
- Kolarik, W. J., Woldstad, J. C., Lu, S. and Lu, H. 2004. Human performance reliability: on-line assessment using fuzzy logic. *IIE Transactions* 36. 5: 457-467. doi:10.1080/07408170490426161
- Kuhn, M. 2013. Desirability: Desirability function optimisation and ranking. R package version. Retrieved 7 Augusty, 2020 <http://CRAN.R-project.org/package=desirability>
- Kulabako, V. 2019. *Noise produced from mechanised quarrying and occupational hazards at Stirling quarry*. (B.Sc.). Makere University. 41.
- Le, T. N., Straatman, L. V., Lea, J. and Westerberg, B. 2017. Current insights in noise-induced hearing loss: a literature review of the underlying mechanism, pathophysiology, asymmetry, and management options. *Journal of Otolaryngology - Head & Neck Surgery* 46. 1: 41. doi:10.1186/s40463-017-0219-x
- Li, G., Wang, H., Aryasomayajula, S., Grandhi, R. 2000. Two level optimisation of airframe structures using response surface approximation. *Structural and Multidisciplinary Optimisation* 20. 2: 116-124.
- Lin, F. R., Metter, E. J., O'Brien, R. J., Resnick, S. M., Zonderman, A. B. and Ferrucci, L. 2011. Hearing loss and incident dementia. *Arch Neurol* 68. 2: 214-220. doi:10.1001/archneurol.2010.362
- Liyana - Pathirana, C. and Shashida, F. (2005). Optimisation of extraction of phenolic compounds from wheat using response surface methodology. *Food Chemistry*. 93(1). 47-56.
- Lostado-Lorza, R., Calvo, M., Berlanga-Labari, C. and Rivero, P. 2018. Using the Multi-Response Method with Desirability Functions to Optimize the Zinc Electroplating of Steel Screws. *Metals* 8. doi:10.3390/met8090711
- Maccà, I., Scapellato, M. L., Carrieri, M., Maso, S., Trevisan, A. and Bartolucci, G. B. 2015. High-frequency hearing thresholds: effects of age, occupational ultrasound and noise exposure. *Int Arch Occup Environ Health* 88. 2: 197-211. doi:10.1007/s00420-014-0951-8
- Mallick, Z., Kaleel, A. H. and Siddiquee, A. N. 2009. An expert system for predicting the effect of noise, pollution on grass trimming task using fuzzy modeling. *International Journal of Applied Environmental Science* 4. 4: 389-403.
- Majumdar, A., and Goyal, A. 2008. Enhanced production of exocellular Glucanase from *Leuconostoc Dextranicum* NRRL B-1146 using response surface method. *Bioresour Technology* 99. 9: 3685 – 3691.

MATLAB Toolbox 2009. Fuzzy Inference System Demo.

Mener, D. J., Betz, J., Genther, D. J., Chen, D. and Lin, F. R. 2013. Hearing loss and depression in older adults. *J Am Geriatr Soc* 61. 9: 1627-1629. doi:10.1111/jgs.12429

Mick, P., Kawachi, I. and Lin, F. R. 2014. The association between hearing loss and social isolation in older adults. *Otolaryngol Head Neck Surg* 150. 3: 378-384. doi:10.1177/0194599813518021

Mingzhi, H., Jinquan, W., Yongwen, M., Yan, W., Weijiang, L. and Xiaofei, S. 2009. Control rules of aeration in a submerged biofilm wastewater treatment process using fuzzy neural networks. *Expert Systems with Applications* 36. 7: 10428-10437. doi:<https://doi.org/10.1016/j.eswa.2009.01.035>

Mohammadi, R., Nassiri, M. and Jafari, S. P. 2009. Risk assessment of workers exposed to noise pollution in a textile plant. *Int J Environ Sci Tech* 6.4: 591-596.

Montgomery, D. and Runger, G. 2007. *Applied statistics and probability for engineers* (4 ed.): John Wiley and Sons, Incorporated.

Montgomery, D. C. 2012. *Design and Analysis of Experiments, 8th Edition*: John Wiley & Sons, Incorporated.

Mulugate, S. 1992. Noise levels in the Ethiopian woodworking industries. *African Newsletter on Occupational Health and Safety* 2.1: 14-17.

Murnleitner, E., Becker, T. M. and Delgado, A. 2002. State detection and control of overloads in the anaerobic wastewater treatment using fuzzy logic. *Water Res* 36.1: 201-211. doi:10.1016/s0043-1354(01)00186-5

Myers, R. H., Montgomery, D. C. and Anderson-Cook, C. M. 2009. *Response Surface Methodology: Process and Product Optimization Using Designed Experiments*: Wiley.

Nanda, S. K. 2012. *Noise Impact Assessment and Prediction in Mines using Soft-Computing Techniques*. (Ph.D). National Institute of Technology, Rourkela. 286.

Nardi, P.M. 2003. *Doing survey research: A guide to qualitative methods*: Boston, M.A.: Allyn and Bacon.

National Bureau of Statistics. 2019. State disaggregated mining and quarrying Data (2018). Retrieved 28 February, 2023 [https://www.nigerianstat.gov.ng/pdfuploads/State\\_Disaggregated\\_Mining\\_and\\_Quarrying\\_Data\\_-\\_2018.pdf](https://www.nigerianstat.gov.ng/pdfuploads/State_Disaggregated_Mining_and_Quarrying_Data_-_2018.pdf)

[Neuman, W. L. 2007. Basics of social research: Qualitative and quantitative approaches. 2<sup>nd</sup> ed. Boston, M.A. : Allyn and Bacon.](#)

Nguyen, T.L., Kavuri, S. and Lee, M. 2019. A multimodal convolutional neuro – fuzzy network for emotion understanding of movie clips. *Neural Networks* 118: 208-219.

- Occupational Health and Safety. (OHS) 2014. Western University hearing protection program. Retrieved 3 June, 2022, from Occupational Health and Safety [https://www.uwo.ca/hr/form\\_doc/health\\_safety/doc/procedures/hearing\\_protection\\_program.pdf](https://www.uwo.ca/hr/form_doc/health_safety/doc/procedures/hearing_protection_program.pdf)
- Ochmann, M., and Piscocya, R. 2021. *Theory and Application of Acoustic Sources Using Complex Analysis: Complex Acoustic Sources, Green's Functions and Half-Space Problems, Acoustic Radiation and Scattering Using Equivalent Source and Boundary Element Methods*: Springer Nature Singapore.
- Oehlert, G. W. 2000. *Design and analysis of experiments: Response surface design*. New York: W.H. Freeman and Company.
- Ojolo, S. J. and Ismail, S. O. (2011). *Mathematical Modelling of Effects of Noise on Machine Operators*. Paper presented at the International Conference on Innovations in Engineering and Technology (IET), Faculty of Engineering, University of Lagos, Akoka-Yaba, Lagos State, Nigeria.
- Oladimeji, Y., Adepoju, S., Galadima, A. and Mohammad Fagge, A. 2019. Socio-economic impact of participation in mining and quarrying on poverty alleviation among rural farming households in Kwara state, Nigeria. *Journal of Agriculture and Environment*. 14: 17-29.
- Onder, M., Onder, S. and Mutlu, A. 2012. Determination of noise induced hearing loss in mining: an application of hierarchical loglinear modelling. *Environ Monit Assess* 184. 4: 2443-2451. doi:10.1007/s10661-011-2129-0
- Ouis, D. 2002. Annoyance caused by exposure to road traffic noise: An update. *Noise and Health* 4. 15: 69-79.
- Pai, T. Y., Wang, S. C., Lo, H. M., Chiang, C. F., Liu, M. H., Chiou, R. J. and Leu, H. G. 2009. Novel modeling concept for evaluating the effects of cadmium and copper on heterotrophic growth and lysis rates in activated sludge process. *Journal of Hazardous Materials* 166. 1: 200-206. doi:<https://doi.org/10.1016/j.jhazmat.2008.11.009>
- Pandey, R. and Thote, N. R. (2005). *Dumper operators expose to noise-some investigations: in*. Paper presented at the proceedings of technological advancement and environmental challenges in mining and allied industries in the 21st century (TECMAC ), India.
- Passino, K. M. and Yurkovich, S. 1998. *Fuzzy control*. Menlo Park: Addison Wesley Longman.
- Perendeci, A., Arslan, S., Tanyolac , A. and Elebi, S. S. 2007. Evaluation of input variables in adaptive-network based fuzzy inference system (ANFIS) modeling for an anaerobic wastewater treatment plant under unsteady conditions. *Journal of Environmental Engineering* 133. 7: 765-772.

- Petković, J., Petrović, N., Dragović, I., Stanojević, K., Radaković, J. A., Borojević, T. and Kljajić Borštnar, M. 2019. Youth and forecasting of sustainable development pillars: An adaptive neuro-fuzzy inference system approach. *PLoS One* 14. 6: e0218855. doi:10.1371/journal.pone.0218855
- Phillips, J. I., Heyns, P. S. and Nelson, G. 2007. Rock drills used in South African mines: a comparative study of noise and vibration levels. *Ann Occup Hyg* 51. 3: 305-310. doi:10.1093/annhyg/mel082
- Pulsar Instruments. 2015. Noise Levels – 10 Most hazardous jobs for your hearing. Retrieved 28 February, 2023 <https://pulsarinstruments.com/news/most-hazardous-jobs-your-hearing/>
- Salam, K., Agarry, S., Olatunde, A. and Shoremekun, I. 2015. Optimization of Operating Conditions Affecting Microbiologically Influenced Corrosion of Mild Steel Exposed to Crude Oil Environments Using Response Surface Methodology. *British Biotechnology Journal* 7. doi:10.9734/BBJ/2015/16810
- Salam, K., Olatunde, A. and Aminu, M. 2018. Application of response surface methodology (RSM) For the modelling and optimization of sand minimum transport condition (MTC) in pipeline multiphase flow. *Petroleum and Coal* 60: 39-340.
- Salam, K., Olatunde, A., Aminu, M. and Sanni, O. 2020. Modelling of mass transfer coefficient of CO<sub>2</sub> in stirred tank bioreactors using Response Surface Methodology.
- Salawu, O. G. and Sadiq, Y. O. 2020. Artisanal quarries in Kaduna metropolis with associated socio-economic benefits. *Science World Journal* 15. 4: 1-6. doi:10.1146/annurev-publhealth-032013-182510
- Salleh, M. N. M., Talpur, N. and Hussain, K. 2017. *Adaptive Neuro-Fuzzy Inference System: Overview, Strengths, Limitations, and Solutions*. Paper presented at the Data Mining and Big Data, Cham.
- Shang, J. S. and Tadikamalla, P. R. 1993. Output maximization of a CIM system: simulation and statistical approach. *International Journal of Production Research* 31. 1: 19-41. doi:10.1080/00207549308956711
- Shukla, A., Harper, M., Pedersen, E., Goman, A., Suen, J. J., Price, C. and Reed, N. S. 2020. Hearing Loss, Loneliness, and Social Isolation: A Systematic Review. *Otolaryngol Head Neck Surg* 162. 5: 622-633. doi:10.1177/0194599820910377
- Stevens, G., Flaxman, S., Brunskill, E., Mascarenhas, M., Mathers, C. D. and Finucane, M. 2011. Global and regional hearing impairment prevalence: an analysis of 42 studies in 29 countries. *Eur J Public Health* 23. 1: 146-152. doi:10.1093/eurpub/ckr176.



- Stoeckle, S., Pah, N., Kumar, D. K. and McLachlan, N. 2001. *Environmental sound sources classification using neural networks*. Paper presented at the The Seventh Australian and New Zealand Intelligent Information Systems Conference, 2001.
- Suskie, L.A.1996. Questionnaire survey research: What works. 2<sup>nd</sup> ed. Tllahassee, FL: Association for Industrial Research.
- Takagi, T. and Sugeno, M. 1985. Fuzzy identification of systems and its application to modeling and control. *IEEE Transactions on Systems, Man and Cybernetics* 15: 116-132.
- Tala-Ighil, N., Fillon, M. and Maspeyrot, P. 2011. Effect of textured area on the performances of a hydrodynamic journal bearing. *Tribology International* 44. 3: 211-219. doi:<https://doi.org/10.1016/j.triboint.2010.10.003>
- Talpur, N., Abdulkadir, S. J. and Hassan, M. H. (2020). *A deep learning based neuro-fuzzy approach for solving classification problems*. Paper presented at the Proceedings of International Conference on Computational Intelligence (ICCI) Universiti Teknologi PETRONAS (UTP) 8th-9th October 2020.
- Tatar, A., Barati-Harooni, A., Najafi-Marghmaleki, A., Norouzi-Farimani, B. and Mohammadi, A. H. 2016. Predictive model based on ANFIS for estimation of thermal conductivity of carbon dioxide. *Journal of Molecular Liquids* 224: 1266-1274. doi:<https://doi.org/10.1016/j.molliq.2016.10.112>
- Torija, A. J., Ruiz, D. P. and Ramos-Ridao, A. F. 2012. Use of back-propagation neural networks to predict both level and temporal-spectral composition of sound pressure in urban sound environments. *Building and Environment* 52: 45-56. doi:<https://doi.org/10.1016/j.buildenv.2011.12.024>
- Tripathy, D. P. and Rao, D. S. 2017. Occupational noise-induced hearing loss of workers in a bauxite mine in India. *Noise Control Engineering Journal* 65. 3: 224-233. doi:<https://doi.org/10.3397/1/376440>
- Tronto, I. F. D. B., Silva, J. D. S. D. and Sant'Anna, N. 2007.. *Comparison of Artificial Neural Network and Regression Models in Software Effort Estimation*. Paper presented at the International Joint Conference on Neural Networks. 12-17 Aug. 2007).
- Ukpong, E. C. 2012. Environmental impact of aggregate mining by crush rock industries in Akamkpa Local Government Area of Cross River State. *Nigerian Journal of Technology* 31. 2: 131-138.
- Vardhan, H., Karmakar, N. and Rao, Y. 2006. Assessment of heavy earth-moving machinery noise vis-a-vis routine maintenance. *Noise Control Engineering Journal - NOISE CONTR ENG J* 54: 64-78. doi:10.3397/1.2888383
- Vardhan, H., Rao, Y. and Karmakar, N. 2004. Noise Analysis of Heavy Earth Moving Machinery Deployed in Opencast Mines and Development of Suitable



Maintenance Guidelines for its Attenuation - Part 3. *Noise & Vibration Worldwide* 35: 11-24. doi:10.1260/0957456042880336

- Verkeyn, A., Botteldooren, D., Tre, G. D. and Caluwe, R. D. (2001, 25-28 July 2001). *Fuzzy modeling of traffic noise annoyance*. Paper presented at the Proceedings Joint 9th IFSA World Congress and 20th NAFIPS International Conference (Cat. No. 01TH8569).
- Vohra, A. and Satyanarayana, T. 2002. Statistical optimisation of the medium components by response surface methodology to enhance Phytase production, *Phychia Anomala. Process Biochemistr* 37. 9: 999-1004.
- W.H.O. 1991. Report of the Informal Working Group on Prevention of Deafness and Hearing Impairment Programme Planning, Geneva, 18-21 June 1991. Available from <http://apps.who.int/iris/> WHO IRIS Retrieved 2 February, 2022, from World Health Organization <https://apps.who.int/iris/handle/10665/58839>
- W.H.O. 1991. Deafness and hearing loss. Retrieved 3 June, 2022, from World Health Organisation <https://www.who.int/news-room/fact-sheets/detail/deafness-and-hearingloss#:~:text=Hearing%20loss%20and%20deafness,moderate%2C%20severe%2C%20or%20profound.>
- W.H.O. 2002. World Health Organisation report 2002: Reducing risks, promoting healthy life. Retrieved 3 June, 2022, from World Health Organisation <https://www.who.int/publications/i/item/9241562072>
- W.H.O. 2003. World Health Organisation report 2003: World hearing day 2023. Retrieved 28 June, 2023, from World Health Organisation <https://www.pacehospital.com>.
- Workman-Davies, C. L. 1989. Noise and hearing in a trackless-mining environment. *J. S. Afr. Inst. Min. Metal* 89. 7: 211-217.
- Wu, L., Yick, K.I., Ng, S.P. and Yip, J. 2012. Application of the Box–Behnken design to the optimization of process parameters in foam cup molding. *Expert Systems with Applications* 39. 9: 8059-8065. doi:<https://doi.org/10.1016/j.eswa.2012.01.137>
- Zaheeruddin, S. and Jain, V. K. 2008. An expert system for predicting the effects of speech interference due to noise pollution on humans using fuzzy approach. *Expert Systems with Applications* 35. 4: 1978-1988. doi:<https://doi.org/10.1016/j.eswa.2007.08.104>
- Zaheeruddin, S., Jain, V. K. and Singh, G. V. 2006. A fuzzy model for noise-induced annoyance. *IEEE Transactions on Systems, Man, and Cybernetics - Part A: Systems and Humans* 36. 4: 697-705. doi:10.1109/TSMCA.2005.851348
- Zaheeruddin, S. Singh, G. V. and Jain, V. K. 2003.. *Fuzzy modelling of human work efficiency in noisy environment*. Paper presented at the The 12th IEEE International Conference on Fuzzy Systems, 25-28 May 2003.

## **APPENDICES**



## Appendix A

### SUMMARY OF WORKS ON THE EFFECT OF NOISE ON HEARING THRESHOLD

**Table A1: Previous Work on Effect of Noise on Hearing Threshold**

| <b>Author</b>              | <b>Work</b>   | <b>Factors Considered</b>   | <b>Method</b>  | <b>Result</b>  | <b>Limitation</b>   |
|----------------------------|---|---|--|--|---|
| Workman-Davies (1989)      | Noise and hearing in a trackless-mining environment   | Age, noise level and NIHL   | Audiometry, sound level meter, SPSS statistical analysis | At age of 30, 10% of workers had hearing loss greater than 25dB and about 7% greater than 40dB; whereas at age 50, the hearing loss continuing increasing.   | Only highlighted the relationship between noise and age. Worker's years of exposure to noise was not considered. No predictive model for the hearing threshold. |
| Ahmed <i>et al.</i> (2001) | High frequency (10-18kHz) hearing thresholds: reliability and effects of age and occupational noise exposure. | Age, noise level, high frequency (10-18kHz) and conventional frequency (0.25-8kHz). | Audiometry, Multivariate analysis.                       | Age affects hearing threshold at both high and conventional frequency. Exposed subjects had higher hearing threshold than non-exposed subject at high frequency considered. Age was the primary predictor, and noise level was the secondary predictor of hearing threshold in high frequency range (10-18kHz). In contrast, noise level was the primary predictor and age was the secondary predictor of hearing threshold in conventional frequency range (0.25-8kHz). | Duration of the exposure of the subjects to the noise not considered in the study. Lack of predictive model(s).   |

**Table A1 (Continued): Previous Work on Effect of Noise on Hearing Threshold**

| <b>Author</b>                 | <b>Work</b>   | <b>Factors Considered</b>   | <b>Method</b>   | <b>Result</b>   | <b>Limitation</b>  |
|-------------------------------|---|---|---|---|--|
| Amedofu (2002)                | Hearing impairment among workers in a surface Gold mining company in Ghana.   | – Age, noise level, years of exposure and hearing loss.                 | Audiometry, sound level meter, SPSS statistical analysis.   | The range of hearing loss was stated among the miners in terms of age, exposure and noise level. Canvassed for noise control in the mining company                    | Lack of predictive model.  |
| Vardhan <i>et al.</i> (2004)  | Assessment of machine generated noise in open cast mines and development of suitable maintenance guidelines for its attenuation | Noise level produced by the machine                                     | Understudying the machine maintenance system, measurement of the noise level from the machine with sound level meter. | Adequate maintenance of machine will lower the noise produced by the machine.   | Impact of noise on workers' age, and exposure not considered. No model predicted.                    |
| Pandey and Thote (2005)       | Dumper operators exposure to noise - some investigations  | Noise level produced by the dumper, years of exposure of the operators. | Sound level meter, years of exposure. Statistical analysis.   | Dumpers operator is exposed to occupational noise levels beyond PEL. Dumper operators having spent 9 years in the operation are mostly with higher hearing threshold. | Only years of exposure and noise level considered. Age was not considered. Lack of predictive model. |
| Phillips <i>et al.</i> (2007) | Rock drills used in South African mines: A comparative study of noise and vibration levels                                      | Noise level on human health. Intermittent noise and continuous noise.   | Questionnaires, statistical analysis.   | Sensitivity of noise varied among the workers.  | Age, years of exposure and frequency not mentioned. No predictive model from any factor(s).          |

**Table A1 (Continued): Previous Work on Effect of Noise on Hearing Threshold**

| <b>Author</b>                  | <b>Work</b>  | <b>Factors Considered</b>   | <b>Method</b>  | <b>Result</b>  | <b>Limitation</b>  |
|--------------------------------|--|---|--|--|--|
| Onder <i>et al.</i> (2012)     | Determination of noise induced hearing loss in mining: an application of hierarchical log linear modelling.            | Age, noise levels, years of exposure and NIHL.                                      | Sound level meter, Statistical analysis and audiometry.                  | Workers with 4-11 years of experience in crushing and screening plants possess higher hearing threshold.   | The cognate result was not based on all workers in the mine. Only some workers' years of exposure was targeted. No predictive model from the factors considered. |
| Kerketta <i>et al.</i> (2012a) | Hearing threshold, loss, noise levels, and worker's profiles of an open cast chromite mines in Odisha, India.          | Age, workstation, length of employment at the mine, hearing threshold.              | Audiometry, sound level meter and ANOVA.                                 | Heavy earth moving machinery (HEMM) operators exposed to noise levels greater than 95dBA. Hearing loss increases as age, workstation and work experiences increase at 4, 6 and 8kHz frequencies. Older and more experienced workers having higher incidence of hearing loss. | Only high frequency 4, 6 and 8kHz were considered.   |
| Kerketta <i>et al.</i> (2012b) | Determination of the test frequency causing significant hearing loss of the mine workers of an open cast chromite mine | Age, work experience, workstations, noise level and frequency causing hearing loss. | Audiometry, sound level meter, SPSS 16.0. Generalised Linear Model ANOVA | Frequency 4kHz and 6kHz are the most influential frequency that caused hearing loss by age and workstation; for year of exposure is 4kHz at 1% level of significance. .  | Only high frequencies (4, 6 and 8kHz) were observed. No predictive model was developed for hearing threshold by using the factors considered.                    |

**Table A1 (Continued): Previous Work on Effect of Noise on Hearing Threshold**

| <b>Author</b>                 | <b>Work</b>  | <b>Factors Considered</b>  | <b>Method</b>   | <b>Result</b>  | <b>Limitation</b>  |
|-------------------------------|--|--|---|--|--|
| Nanda (2012)                  | Noise impact assessment and prediction in mines using soft computing techniques  | Noise level produced by the machinery in the mines, NIHL frequency exposure. | Sound level meter, Adaptive Neuro Fuzzy Inference System (ANFIS), Multilayer perception (MLP), Radical Basis Function Network (RBFN), Fuzzy Inference system for the development of frequency noise prediction model. | ANFIS gave better accuracy as compared to other soft-computing techniques. Models were developed.  | Age and years of exposure were not considered in the modeling.                                       |
| Ismail <i>et al.</i> , (2013) | Noise – Induced hearing loss among quarry workers in a North-Eastern state of Malaysia: A study on knowledge, attitude and practice. | Age, years of exposure, noise level, hearing Loss.                           | Logistic regressions, measurement of noise exposure, audiometry.  | Noise is one of the occupational hazards and environmental pollutants in quarries causing NIHL among workers. Workers not engage in using personal protective equipment. | Not given the precise level of NIHL on the factors. No predictive model from the factors considered. |

**Table A1 (Continued): Previous Work on Effect of Noise on Hearing Threshold**

| <b>Author</b>                   | <b>Work</b>   | <b>Factors Considered</b>                  | <b>Method</b>  | <b>Result</b>   | <b>Limitation</b>   |
|---------------------------------|---|--|--|---|---|
| Kerketta <i>et al.</i> , (2016) | Assessment of noise induced hearing loss of the mine workers of Chromite mines at Sukinda, Odisha, India. | Age, years of exposure and workstations.   | Audiometry, 16.0 package, Generalized Linear Model ANOVA.                            | SPSS package, Linear Model ANOVA. Subjects will develop NIHL after 25years of starting work at noisy work zone in the open cast chromite mines. Workstation is the primary influential factor for the NIHL. | Noise level and frequency was not considered. Specific age bracket for the workers that can justify the 25 years of exposure not highlighted. There was no predictive model for the hearing threshold prediction from the factors considered. |
| Akanbi and Oriolowo (2016)      | Modelling the prevention of transformation of presbycusis to noise induced hearing loss.                  | Age, years of exposure                     | Noise exposure measurement, Audiometry, Statistical analysis of one factor at a time | Age of the workers was the major contributory factor.   | No interacting effects were explored.   |
| Gyanfi <i>et al.</i> , (2016)   | Noise Exposure and hearing capabilities of quarry workers in Ghana: A cross-sectionals study.             | Age, duration of exposure, ear plug usage. | Sound level meter, structured questionnaires, audiometry, Logistic regression.       | Machine used at the quarry sites produced noise beyond permissible exposure limit, usage of the PPE reduced the development of NIHL   | Effect of noise level on age not considered.  |



**Table A1 (Continued): Previous Work on Effect of Noise on Hearing Threshold**

| <b>Author</b>                | <b>Work</b>  | <b>Factors Considered</b>   | <b>Method</b>  | <b>Result</b>   | <b>Limitation</b>  |
|------------------------------|--|---|--|---|--|
| Tripathy and Rao (2017)      | Assessment of Noise Induced Hearing Loss (NIHL) of mine workers in a Bauxite mine using fuzzy logic. | Age, exposure, noise level and frequency.                                   | Digital audiometer, SPSS design.   | 2.3% of the miners (38-55 years of age) were NIHL affected.   | Lack of modelling equation for prediction at a particular frequency with the factors considered. |
| Akanbi <i>et al.</i> (2021). | Models for estimating the hearing threshold of quarry workers at high frequencies                    | Age, years of exposure, noise level, main factors and interactions effects. | Age, years of exposure, noise level measurement, audiometry, SPSS statistical design, ANOVA. Considered only 3, 4, 6 and 8kHz frequency. | Predicted that noise levels have highest contribution and age has the least prediction ability in hearing threshold of workers. Age, years of exposure and noise level independently predicted the hearing threshold at frequency 4 and 6kHz; years of exposure, noise level independently predicted the hearing threshold at frequency 3kHz; and only noise level independently predicted hearing threshold at frequency 6kHz. No interactive factors predictors at the high frequencies considered. All predicted models were in linear form. | Not specified the age, or years at which factors interaction influences the hearing threshold.   |

## APPENDIX B

### CONSENT AND VOLUNTARY PARTICIPATION FORM

#### INTRODUCTION

I-----have been invited to participate in this research study which has been explained to me by Oriolowo Kolawole Taofik. This research is being conducted by Engr. Oriolowo Kolawole Taofik to fulfil the requirements for a Ph.D. thesis in Industrial and Production Engineering Department in the University of Ibadan.

**PURPOSE:** The purpose of this study is to conduct research on my occupation with regards to my hearing capabilities

**PROCEDURES:** (1) Practical consultation of quarry workers, (2) medical investigation on hearing capabilities (Audiogram) and (3) a questionnaire asking about my work history.

**RISKS AND DISCOMFORTS:** The procedure involved in conducting research will not create any risk or discomfort to me during and after the research other than the situation occurrence during a normal day's work.

**CONTACT PERSON:** Oriolowo Kolawole Taofik on 08027347109, or his supervisor, Prof. O.G. Akanbi on 08023387396, can be contacted for more information regarding my rights as a subject.

**CONFIDENTIALITY:** Any information about me obtained when participating in this research will be kept as secret and confidential. Also my research records may be subpoenaed by court order or be inspected by federal regulatory authorities. In case of any publication that results from this research, none of my personal identification information will be published without my consent.

**VOLUNTARY PARTICIPATION:** I am participating in this study voluntarily. My consent can be withdrawn at any time if I wish. I understand that it is not compulsory for

me to answer all questions in the questionnaire if I do not wish to do so, which attract no penalty. I had asked question about the research, which had been answered adequately concerning areas which I did not understand before signing this form. I voluntarily participated in this research.

Subject's Name ..... Signature ..... Time .....

Investigator's Name ..... Signature ..... Time ...

**APPENDIX C**  
**QUESTIONNAIRE ON HEARING THRESHOLD FOR THE QUARRY**  
**WORKERS**

**UNIVERSITY OF IBADAN**  
**FACULTY OF TECHNOLOGY**  
**INDUSTRIAL & PRODUCTION ENGINEERING DEPARTMENT**

**Research Questionnaire**

Subject Number \_\_\_\_\_

The following questions request you to provide information about yourself. Your responses to these questions will be kept confidential. Your honest response is needed as possible throughout. The information provided is only for research purpose.

- 1) Age:
- 2) Gender (Circle one): Male Female
- 3) Years of experience
- 4) Job position:
- 5) Do you operate machine? yes (  ) No (  )
- 6) If yes type of machine
- 7) Have you ever sustained any injury which resulted to the hearing problem? Yes / No  
a) If “Yes,” please describe the injury and estimate the approximate injury period.
- 8) Please circle any of the following specific illnesses or conditions, either if you presently have, or if you had the illness/condition in the past.  
(a) Tuberculosis (b) Ulcer (c) Diabetes (d) Hearing problems (e) Sight problems (f) Hypertension (g) Specify Others. ....

**APPENDIX D**  
**2018 EXPERIMENT**

**Table D1: Age, Years of Exposure, Noise level and Hearing Threshold of the Quarry Workers in the year 2018**

| NO  | Factors |    |       | Hearing threshold |       |      |      |      |      |      |      |
|-----|---------|----|-------|-------------------|-------|------|------|------|------|------|------|
|     | AG      | YE | NL    | 250Hz             | 500Hz | 1kHz | 2kHz | 3kHz | 4kHz | 6kHz | 8kHz |
| 1.  | 52      | 26 | 115   | 36                | 48    | 55   | 58   | 60   | 84   | 73   | 74   |
| 2.  | 56      | 33 | 115   | 33                | 48    | 65   | 68   | 70   | 94   | 76   | 72   |
| 3.  | 56      | 26 | 115   | 30                | 45    | 48   | 59   | 70   | 90   | 69   | 71   |
| 4.  | 50      | 19 | 115   | 27                | 35    | 40   | 42   | 48   | 60   | 55   | 58   |
| 5.  | 42      | 21 | 116.9 | 30                | 32    | 35   | 39   | 45   | 50   | 45   | 53   |
| 6.  | 55      | 27 | 116.9 | 32                | 47    | 50   | 61   | 72   | 89   | 67   | 73   |
| 7.  | 63      | 35 | 116.9 | 33                | 50    | 55   | 60   | 69   | 89   | 71   | 82   |
| 8.  | 49      | 22 | 116.9 | 32                | 33    | 35   | 37   | 40   | 60   | 50   | 57   |
| 9.  | 51      | 18 | 116.9 | 29                | 33    | 35   | 40   | 45   | 60   | 45   | 55   |
| 10. | 52      | 13 | 113.5 | 31                | 33    | 34   | 37   | 40   | 64   | 42   | 60   |
| 11. | 47      | 20 | 113.5 | 28                | 30    | 34   | 38   | 42   | 53   | 47   | 51   |
| 12. | 35      | 13 | 113.5 | 25                | 26    | 29   | 31   | 35   | 36   | 37   | 32   |
| 13. | 58      | 25 | 113.5 | 25                | 34    | 40   | 48   | 51   | 60   | 48   | 59   |
| 14. | 26      | 07 | 96    | 17                | 20    | 22   | 25   | 26   | 27   | 20   | 29   |
| 15. | 45      | 19 | 96    | 23                | 27    | 30   | 34   | 36   | 50   | 34   | 43   |

**Table D1 (Continued): Age, Years of Exposure, Noise level and Hearing Threshold of the Quarry Workers in the year 2018**

| NO | Factors |    |      | Hearing threshold |       |      |      |      |      |      |      |
|----|---------|----|------|-------------------|-------|------|------|------|------|------|------|
|    | AG      | YE | NL   | 250Hz             | 500Hz | 1kHz | 2kHz | 3kHz | 4kHz | 6kHz | 8kHz |
| 16 | 34      | 14 | 96   | 26                | 31    | 35   | 35   | 37   | 52   | 34   | 37   |
| 17 | 49      | 21 | 96   | 26                | 27    | 36   | 37   | 40   | 55   | 35   | 40   |
| 18 | 25      | 03 | 96   | 16                | 21    | 23   | 26   | 27   | 28   | 29   | 30   |
| 19 | 40      | 19 | 94.4 | 25                | 30    | 36   | 40   | 43   | 55   | 39   | 44   |
| 20 | 30      | 10 | 94.4 | 24                | 27    | 29   | 30   | 30   | 31   | 25   | 30   |
| 21 | 43      | 20 | 94.4 | 25                | 30    | 38   | 40   | 45   | 55   | 33   | 44   |
| 22 | 27      | 06 | 94.4 | 17                | 21    | 23   | 26   | 28   | 31   | 24   | 30   |
| 23 | 39      | 14 | 94.4 | 20                | 24    | 27   | 27   | 30   | 53   | 36   | 50   |
| 24 | 43      | 21 | 94.4 | 23                | 26    | 34   | 38   | 40   | 58   | 36   | 39   |
| 25 | 38      | 19 | 94.4 | 22                | 29    | 29   | 35   | 39   | 53   | 38   | 40   |
| 26 | 32      | 11 | 93.1 | 23                | 25    | 34   | 35   | 36   | 50   | 28   | 30   |
| 27 | 36      | 25 | 93.1 | 23                | 28    | 30   | 37   | 40   | 45   | 40   | 44   |
| 28 | 44      | 24 | 93.1 | 28                | 33    | 34   | 36   | 45   | 50   | 39   | 41   |
| 29 | 41      | 19 | 93.1 | 27                | 27    | 30   | 35   | 39   | 58   | 44   | 53   |
| 30 | 42      | 20 | 93.1 | 27                | 29    | 30   | 35   | 38   | 58   | 47   | 59   |
| 31 | 54      | 23 | 93.1 | 34                | 37    | 45   | 50   | 65   | 90   | 70   | 81   |
| 32 | 48      | 20 | 93.1 | 29                | 31    | 35   | 43   | 50   | 66   | 44   | 59   |
| 33 | 24      | 06 | 93.0 | 14                | 19    | 22   | 25   | 29   | 28   | 23   | 26   |
| 34 | 37      | 14 | 93.0 | 23                | 25    | 26   | 30   | 31   | 35   | 29   | 31   |

**Table D1 (Continued): Age, Years of Exposure, Noise level and Hearing Threshold of the Quarry Workers in the year 2018**

| NO  | Factors |    |       | Hearing threshold |       |      |      |      |      |      |      |
|-----|---------|----|-------|-------------------|-------|------|------|------|------|------|------|
|     | AG      | YE | NL    | 250Hz             | 500Hz | 1kHz | 2kHz | 3kHz | 4kHz | 6kHz | 8kHz |
| 35  | 37      | 18 | 93.0  | 23                | 25    | 27   | 30   | 31   | 37   | 29   | 33   |
| 36  | 54      | 29 | 88.3  | 29                | 31    | 38   | 41   | 50   | 90   | 71   | 62   |
| 37  | 45      | 20 | 88.3  | 29                | 38    | 40   | 42   | 48   | 62   | 55   | 60   |
| 38  | 60      | 35 | 97.3  | 33                | 36    | 43   | 45   | 53   | 91   | 89   | 71   |
| 39  | 21      | 03 | 45    | 20                | 22    | 22   | 23   | 23   | 24   | 20   | 21   |
| 40  | 21      | 04 | 45    | 21                | 24    | 25   | 25   | 25   | 27   | 21   | 23   |
| 41  | 25      | 07 | 112.3 | 21                | 24    | 26   | 27   | 28   | 29   | 26   | 30   |
| 42. | 36      | 13 | 112.3 | 21                | 23    | 28   | 32   | 34   | 36   | 28   | 33   |
| 43. | 30      | 08 | 112.3 | 22                | 24    | 26   | 27   | 28   | 33   | 25   | 28   |
| 44. | 31      | 13 | 112.3 | 22                | 23    | 25   | 27   | 29   | 33   | 31   | 32   |
| 45. | 47      | 25 | 112.3 | 30                | 32    | 35   | 40   | 42   | 50   | 38   | 45   |
| 46. | 51      | 26 | 112.3 | 26                | 30    | 38   | 42   | 45   | 70   | 63   | 65   |
| 47. | 53      | 30 | 112.3 | 27                | 30    | 35   | 39   | 43   | 85   | 56   | 61   |
| 48. | 35      | 13 | 108.3 | 22                | 25    | 31   | 38   | 41   | 44   | 37   | 40   |
| 49. | 21      | 03 | 108.3 | 18                | 21    | 23   | 26   | 28   | 28   | 24   | 29   |
| 50. | 27      | 06 | 108.3 | 21                | 23    | 26   | 28   | 28   | 30   | 24   | 29   |
| 51. | 51      | 24 | 94.5  | 32                | 35    | 40   | 45   | 50   | 89   | 50   | 60   |
| 52. | 48      | 23 | 94.5  | 26                | 30    | 35   | 41   | 47   | 65   | 41   | 49   |
| 53. | 43      | 19 | 94.5  | 29                | 30    | 41   | 43   | 50   | 62   | 42   | 51   |

**Table D1 (Continued): Age, Years of Exposure, Noise level and Hearing Threshold of the Quarry Workers in the year 2018**

| NO  | Factors |    |      | Hearing threshold |       |      |      |      |      |      |      |
|-----|---------|----|------|-------------------|-------|------|------|------|------|------|------|
|     | AG      | YE | NL   | 250Hz             | 500Hz | 1kHz | 2kHz | 3kHz | 4kHz | 6kHz | 8kHz |
| 54. | 41      | 20 | 94.5 | 23                | 25    | 30   | 43   | 47   | 61   | 44   | 46   |
| 55. | 24      | 06 | 94.5 | 21                | 22    | 23   | 24   | 25   | 27   | 24   | 26   |
| 56. | 35      | 12 | 91.1 | 22                | 24    | 25   | 28   | 32   | 35   | 27   | 29   |
| 57. | 29      | 07 | 91.1 | 23                | 24    | 25   | 26   | 28   | 29   | 26   | 28   |
| 58. | 30      | 12 | 91.1 | 23                | 24    | 27   | 28   | 30   | 31   | 30   | 31   |
| 59. | 34      | 14 | 91.1 | 25                | 29    | 30   | 35   | 35   | 39   | 33   | 30   |
| 60. | 28      | 10 | 91.1 | 17                | 20    | 22   | 24   | 27   | 28   | 25   | 27   |
| 61. | 52      | 29 | 91.1 | 30                | 32    | 40   | 48   | 50   | 77   | 46   | 68   |
| 62. | 34      | 13 | 91.5 | 20                | 22    | 25   | 25   | 27   | 30   | 24   | 29   |
| 63. | 20      | 02 | 91.5 | 16                | 18    | 22   | 23   | 25   | 27   | 23   | 24   |
| 64. | 34      | 13 | 91.5 | 22                | 23    | 23   | 25   | 27   | 29   | 24   | 27   |
| 65. | 50      | 24 | 91.5 | 30                | 33    | 40   | 41   | 51   | 65   | 45   | 60   |
| 66. | 47      | 26 | 91.5 | 28                | 30    | 39   | 43   | 48   | 75   | 55   | 65   |
| 67. | 52      | 29 | 91.5 | 30                | 33    | 35   | 42   | 47   | 81   | 69   | 74   |
| 68  | 48      | 22 | 91.5 | 35                | 37    | 43   | 48   | 55   | 66   | 47   | 59   |
| 69  | 40      | 20 | 97.2 | 23                | 37    | 40   | 50   | 53   | 60   | 51   | 58   |
| 70  | 45      | 19 | 97.2 | 28                | 35    | 43   | 45   | 50   | 65   | 43   | 61   |
| 71  | 34      | 12 | 97.2 | 21                | 24    | 26   | 29   | 30   | 32   | 25   | 30   |
| 72  | 50      | 28 | 97.2 | 29                | 30    | 38   | 49   | 65   | 70   | 63   | 69   |



**Table D1 (Continued): Age, Years of Exposure, Noise level and Hearing Threshold of the Quarry Workers in the year 2018**

| NO | Factors |    |       | Hearing threshold |       |      |      |      |      |      |      |
|----|---------|----|-------|-------------------|-------|------|------|------|------|------|------|
|    | AG      | YE | NL    | 250Hz             | 500Hz | 1kHz | 2kHz | 3kHz | 4kHz | 6kHz | 8kHz |
| 73 | 48      | 21 | 87.3  | 25                | 30    | 31   | 40   | 50   | 73   | 61   | 69   |
| 74 | 40      | 14 | 87.3  | 22                | 25    | 29   | 30   | 39   | 45   | 42   | 44   |
| 75 | 29      | 06 | 87.3  | 20                | 22    | 27   | 28   | 30   | 31   | 25   | 31   |
| 76 | 51      | 28 | 87.3  | 30                | 35    | 45   | 49   | 69   | 80   | 70   | 72   |
| 77 | 52      | 33 | 93.2  | 32                | 38    | 40   | 50   | 55   | 88   | 63   | 78   |
| 78 | 33      | 12 | 93.2  | 20                | 20    | 26   | 28   | 30   | 32   | 29   | 33   |
| 79 | 35      | 14 | 93.2  | 20                | 23    | 26   | 28   | 30   | 34   | 30   | 32   |
| 80 | 38      | 13 | 30.2  | 21                | 22    | 24   | 25   | 27   | 30   | 25   | 28   |
| 81 | 41      | 11 | 37.8  | 22                | 23    | 24   | 34   | 36   | 40   | 26   | 38   |
| 82 | 37      | 12 | 44.3  | 20                | 21    | 23   | 25   | 27   | 31   | 26   | 29   |
| 83 | 37      | 15 | 49.3  | 20                | 25    | 26   | 28   | 32   | 33   | 25   | 28   |
| 84 | 34      | 18 | 28.4  | 24                | 27    | 28   | 30   | 31   | 35   | 33   | 29   |
| 85 | 35      | 10 | 38.4  | 20                | 21    | 22   | 23   | 25   | 30   | 26   | 28   |
| 86 | 29      | 10 | 50.0  | 20                | 21    | 23   | 25   | 30   | 32   | 28   | 30   |
| 87 | 34      | 15 | 114.3 | 25                | 25    | 27   | 28   | 30   | 32   | 28   | 30   |
| 88 | 35      | 12 | 114.3 | 21                | 23    | 27   | 28   | 30   | 31   | 27   | 30   |
| 89 | 53      | 21 | 114.3 | 32                | 39    | 47   | 51   | 55   | 61   | 37   | 59   |
| 90 | 32      | 06 | 114.3 | 21                | 23    | 25   | 27   | 29   | 30   | 23   | 28   |
| 91 | 38      | 19 | 114.3 | 21                | 25    | 28   | 30   | 31   | 30   | 30   | 34   |

**Table D1 (Continued): Age, Years of Exposure, Noise level and Hearing Threshold of the Quarry Workers in the year 2018**

| NO  | Factors |    |       | Hearing threshold |       |      |      |      |      |      |      |
|-----|---------|----|-------|-------------------|-------|------|------|------|------|------|------|
|     | AG      | YE | NL    | 250Hz             | 500Hz | 1kHz | 2kHz | 3kHz | 4kHz | 6kHz | 8kHz |
| 92  | 51      | 22 | 114.3 | 30                | 43    | 53   | 55   | 60   | 65   | 52   | 64   |
| 93  | 38      | 07 | 114.9 | 21                | 22    | 23   | 24   | 26   | 28   | 23   | 28   |
| 94  | 59      | 23 | 114.9 | 29                | 36    | 43   | 54   | 59   | 68   | 43   | 56   |
| 95  | 18      | 03 | 114.9 | 20                | 22    | 24   | 26   | 29   | 30   | 24   | 26   |
| 96  | 44      | 12 | 114.9 | 25                | 28    | 28   | 26   | 28   | 35   | 28   | 33   |
| 97  | 39      | 14 | 114.9 | 27                | 30    | 32   | 36   | 38   | 42   | 39   | 41   |
| 98  | 41      | 19 | 113   | 20                | 22    | 40   | 43   | 51   | 65   | 43   | 61   |
| 99  | 36      | 17 | 113   | 20                | 24    | 27   | 27   | 28   | 29   | 24   | 28   |
| 100 | 34      | 19 | 113   | 22                | 26    | 28   | 30   | 32   | 31   | 26   | 29   |
| 101 | 44      | 20 | 113   | 27                | 30    | 32   | 33   | 35   | 47   | 27   | 36   |
| 102 | 39      | 14 | 113   | 27                | 32    | 33   | 36   | 35   | 37   | 29   | 33   |
| 103 | 41      | 21 | 113   | 26                | 30    | 32   | 35   | 37   | 41   | 35   | 37   |
| 104 | 51      | 24 | 113   | 28                | 30    | 33   | 39   | 50   | 65   | 43   | 55   |
| 105 | 27      | 09 | 113   | 20                | 22    | 23   | 27   | 28   | 35   | 27   | 29   |
| 106 | 36      | 19 | 92.8  | 26                | 28    | 30   | 35   | 40   | 44   | 41   | 40   |
| 107 | 59      | 34 | 92.8  | 27                | 31    | 30   | 35   | 44   | 72   | 48   | 63   |
| 108 | 55      | 34 | 92.8  | 31                | 33    | 37   | 47   | 50   | 62   | 49   | 58   |
| 109 | 31      | 13 | 92.8  | 20                | 22    | 24   | 27   | 30   | 31   | 28   | 31   |
| 110 | 46      | 23 | 92.8  | 20                | 25    | 33   | 39   | 50   | 65   | 49   | 60   |

**Table D1 (Continued): Age, Years of Exposure, Noise level and Hearing Threshold of the Quarry Workers in the year 2018**

| NO  | Factors |    |      | Hearing threshold |       |      |      |      |      |      |      |
|-----|---------|----|------|-------------------|-------|------|------|------|------|------|------|
|     | AG      | YE | NL   | 250Hz             | 500Hz | 1kHz | 2kHz | 3kHz | 4kHz | 6kHz | 8kHz |
| 111 | 47      | 22 | 92.8 | 30                | 32    | 39   | 45   | 51   | 60   | 49   | 44   |
| 112 | 45      | 25 | 92.8 | 25                | 29    | 30   | 35   | 42   | 68   | 43   | 58   |
| 113 | 37      | 15 | 92.8 | 20                | 21    | 23   | 24   | 26   | 33   | 25   | 31   |
| 114 | 47      | 22 | 92.8 | 35                | 37    | 41   | 45   | 60   | 65   | 45   | 52   |
| 115 | 46      | 27 | 92.8 | 28                | 31    | 36   | 42   | 50   | 60   | 51   | 54   |
| 116 | 36      | 18 | 92.3 | 30                | 33    | 37   | 39   | 40   | 50   | 38   | 40   |
| 117 | 58      | 33 | 92.3 | 30                | 36    | 40   | 50   | 51   | 65   | 45   | 60   |
| 118 | 68      | 37 | 92.3 | 35                | 42    | 49   | 57   | 59   | 72   | 54   | 69   |
| 119 | 32      | 13 | 92.3 | 21                | 24    | 26   | 29   | 30   | 35   | 25   | 30   |
| 120 | 29      | 07 | 92.3 | 20                | 21    | 23   | 25   | 27   | 30   | 25   | 26   |
| 121 | 43      | 22 | 92.3 | 28                | 34    | 39   | 46   | 53   | 59   | 30   | 48   |
| 122 | 46      | 22 | 92.3 | 30                | 35    | 39   | 43   | 54   | 58   | 35   | 47   |
| 123 | 36      | 12 | 92.3 | 25                | 25    | 27   | 35   | 37   | 39   | 20   | 29   |
| 124 | 34      | 11 | 92.3 | 20                | 22    | 24   | 25   | 28   | 35   | 22   | 27   |
| 125 | 39      | 10 | 92.3 | 23                | 25    | 27   | 30   | 32   | 37   | 24   | 30   |
| 126 | 42      | 13 | 92.3 | 25                | 28    | 31   | 33   | 35   | 37   | 30   | 33   |
| 127 | 49      | 20 | 92.8 | 31                | 36    | 40   | 49   | 55   | 64   | 41   | 55   |
| 128 | 55      | 12 | 92.3 | 26                | 38    | 47   | 50   | 58   | 67   | 30   | 59   |
| 129 | 44      | 25 | 92.8 | 34                | 35    | 40   | 49   | 50   | 64   | 42   | 47   |

**Table D1 (Continued): Age, Years of Exposure, Noise level and Hearing Threshold of the Quarry Workers in the year 2018**

| NO  | Factors |    |       | Hearing threshold |       |      |      |      |      |      |      |
|-----|---------|----|-------|-------------------|-------|------|------|------|------|------|------|
|     | AG      | YE | NL    | 250Hz             | 500Hz | 1kHz | 2kHz | 3kHz | 4kHz | 6kHz | 8kHz |
| 130 | 49      | 20 | 92.8  | 33                | 36    | 40   | 48   | 52   | 70   | 45   | 58   |
| 131 | 45      | 20 | 92.8  | 30                | 35    | 38   | 43   | 50   | 60   | 34   | 41   |
| 132 | 44      | 19 | 92.8  | 29                | 33    | 40   | 48   | 51   | 63   | 40   | 52   |
| 133 | 47      | 16 | 92.8  | 30                | 34    | 40   | 51   | 53   | 68   | 40   | 53   |
| 134 | 37      | 17 | 92.8  | 23                | 27    | 33   | 41   | 50   | 60   | 32   | 43   |
| 135 | 41      | 22 | 92.8  | 26                | 30    | 40   | 43   | 50   | 66   | 28   | 49   |
| 136 | 38      | 17 | 97.0  | 20                | 22    | 23   | 30   | 33   | 45   | 28   | 39   |
| 137 | 35      | 15 | 97.0  | 25                | 27    | 29   | 31   | 33   | 45   | 33   | 42   |
| 138 | 39      | 10 | 97.0  | 23                | 25    | 27   | 30   | 32   | 37   | 24   | 30   |
| 139 | 52      | 29 | 97.0  | 29                | 31    | 35   | 41   | 52   | 72   | 54   | 69   |
| 140 | 51      | 33 | 97.0  | 30                | 33    | 37   | 40   | 50   | 75   | 49   | 70   |
| 141 | 39      | 16 | 97.0  | 28                | 32    | 34   | 41   | 45   | 65   | 49   | 61   |
| 142 | 40      | 15 | 59.0  | 26                | 28    | 30   | 35   | 40   | 52   | 35   | 43   |
| 143 | 48      | 24 | 60.4  | 27                | 31    | 35   | 41   | 49   | 66   | 41   | 51   |
| 144 | 50      | 29 | 40.6  | 26                | 31    | 34   | 40   | 48   | 67   | 30   | 53   |
| 145 | 35      | 13 | 114.5 | 23                | 24    | 24   | 25   | 29   | 31   | 21   | 22   |
| 146 | 51      | 31 | 114.5 | 24                | 30    | 38   | 47   | 52   | 63   | 39   | 55   |
| 147 | 49      | 20 | 114.5 | 27                | 31    | 35   | 40   | 49   | 61   | 43   | 45   |
| 148 | 39      | 10 | 114.5 | 24                | 25    | 27   | 30   | 35   | 37   | 24   | 34   |

**Table D1 (Continued): Age, Years of Exposure, Noise level and Hearing Threshold of the Quarry Workers in the year 2018**

| NO  | Factors |    |       | Hearing threshold |       |      |      |           |           |      |      |
|-----|---------|----|-------|-------------------|-------|------|------|-----------|-----------|------|------|
|     | AG      | YE | NL    | 250Hz             | 500Hz | 1kHz | 2kHz | 3kHz      | 4kHz      | 6kHz | 8kHz |
| 149 | 40      | 17 | 112.2 | 23                | 29    | 36   | 40   | 49        | 57        | 31   | 52   |
| 150 | 52      | 27 | 112.2 | 27                | 30    | 39   | 42   | <b>50</b> | 87        | 47   | 62   |
| 151 | 53      | 32 | 112.2 | 29                | 32    | 39   | 44   | 56        | 73        | 52   | 69   |
| 152 | 34      | 13 | 112.2 | 22                | 23    | 25   | 26   | 28        | 30        | 28   | 27   |
| 153 | 30      | 14 | 112.2 | 20                | 22    | 23   | 25   | 30        | 35        | 28   | 28   |
| 154 | 39      | 18 | 101.7 | 25                | 27    | 30   | 33   | 35        | 45        | 31   | 38   |
| 155 | 42      | 20 | 101.7 | 27                | 32    | 35   | 39   | 43        | 70        | 33   | 45   |
| 156 | 38      | 16 | 101.7 | 20                | 25    | 27   | 30   | 32        | 45        | 28   | 30   |
| 157 | 48      | 16 | 101.7 | 28                | 32    | 39   | 44   | 51        | <b>63</b> | 43   | 52   |
| 158 | 29      | 10 | 101.7 | 23                | 25    | 27   | 30   | 32        | 37        | 29   | 30   |
| 159 | 46      | 21 | 96.5  | 27                | 30    | 33   | 39   | 42        | 56        | 35   | 53   |
| 160 | 30      | 11 | 96.5  | 19                | 22    | 25   | 29   | 30        | 32        | 27   | 29   |
| 161 | 51      | 31 | 96.5  | 30                | 38    | 45   | 51   | 59        | 69        | 40   | 59   |
| 162 | 35      | 13 | 96.5  | 20                | 23    | 25   | 27   | 30        | 38        | 30   | 25   |
| 163 | 29      | 07 | 96.5  | 20                | 23    | 23   | 26   | 27        | 29        | 24   | 27   |
| 164 | 41      | 17 | 96.5  | 25                | 28    | 30   | 39   | 43        | 71        | 39   | . 62 |
| 165 | 55      | 33 | 96.5  | 30                | 39    | 44   | 50   | 57        | 82        | 59   | 73   |
| 166 | 56      | 36 | 98.1  | 31                | 36    | 43   | 50   | 56        | 72        | 40   | 58   |
| 167 | 20      | 01 | 98.1  | 19                | 22    | 24   | 27   | 28        | 30        | 25   | 23   |

**Table D1 (Continued): Age, Years of Exposure, Noise level and Hearing Threshold of the Quarry Workers in the year 2018**

| NO  | Factors |    |      | Hearing threshold |       |      |      |      |      |      |      |
|-----|---------|----|------|-------------------|-------|------|------|------|------|------|------|
|     | AG      | YE | NL   | 250Hz             | 500Hz | 1kHz | 2kHz | 3kHz | 4kHz | 6kHz | 8kHz |
| 168 | 43      | 22 | 98.1 | 24                | 29    | 33   | 42   | 51   | 56   | 34   | 43   |
| 169 | 35      | 18 | 98.1 | 20                | 22    | 23   | 25   | 26   | 30   | 24   | 27   |
| 170 | 49      | 21 | 98.1 | 21                | 24    | 27   | 30   | 35   | 57   | 43   | 47   |
| 171 | 45      | 20 | 98.1 | 23                | 25    | 34   | 39   | 44   | 59   | 30   | 41   |
| 172 | 39      | 08 | 92.3 | 23                | 25    | 27   | 30   | 32   | 37   | 24   | 30   |
| 173 | 33      | 12 | 93.3 | 22                | 24    | 26   | 27   | 28   | 30   | 23   | 28   |
| 174 | 49      | 23 | 93.3 | 29                | 38    | 37   | 41   | 53   | 78   | 38   | 50   |
| 175 | 60      | 37 | 93.3 | 30                | 35    | 41   | 46   | 50   | 74   | 47   | 65   |
| 176 | 50      | 26 | 93.3 | 26                | 32    | 37   | 42   | 51   | 64   | 37   | 56   |
| 177 | 39      | 10 | 93.3 | 23                | 25    | 27   | 30   | 32   | 37   | 24   | 30   |
| 178 | 38      | 19 | 90.2 | 23                | 25    | 29   | 30   | 32   | 34   | 28   | 30   |
| 179 | 43      | 22 | 90.2 | 25                | 28    | 36   | 42   | 49   | 61   | 38   | 59   |
| 180 | 39      | 11 | 88.2 | 21                | 23    | 26   | 28   | 29   | 30   | 25   | 29   |
| 181 | 36      | 15 | 88.2 | 20                | 23    | 26   | 28   | 30   | 36   | 27   | 28   |
| 182 | 46      | 19 | 88.2 | 24                | 29    | 35   | 39   | 43   | 61   | 37   | 50   |
| 183 | 30      | 11 | 88.2 | 22                | 25    | 28   | 30   | 31   | 32   | 26   | 29   |
| 184 | 40      | 19 | 95.4 | 26                | 31    | 35   | 40   | 45   | 55   | 31   | 35   |
| 185 | 50      | 22 | 95.4 | 25                | 31    | 35   | 40   | 47   | 68   | 37   | 59   |
| 186 | 54      | 31 | 95.4 | 35                | 44    | 49   | 52   | 55   | 79   | 44   | 59   |

**Table D1 (Continued): Age, Years of Exposure, Noise level and Hearing Threshold of the Quarry Workers in the year 2018**

| NO  | Factors |    |      | Hearing threshold |       |      |      |      |      |      |      |
|-----|---------|----|------|-------------------|-------|------|------|------|------|------|------|
|     | AG      | YE | NL   | 250Hz             | 500Hz | 1kHz | 2kHz | 3kHz | 4kHz | 6kHz | 8kHz |
| 187 | 49      | 22 | 58.4 | 25                | 30    | 32   | 35   | 40   | 50   | 29   | 39   |
| 188 | 34      | 13 | 49.5 | 18                | 24    | 26   | 27   | 28   | 34   | 29   | 27   |
| 189 | 39      | 10 | 92.3 | 23                | 25    | 27   | 30   | 32   | 37   | 24   | 30   |
| 190 | 26      | 05 | 80.0 | 18                | 22    | 23   | 27   | 29   | 30   | 24   | 25   |
| 191 | 36      | 14 | 55.0 | 21                | 24    | 25   | 26   | 28   | 30   | 28   | 29   |
| 192 | 58      | 29 | 90   | 28                | 32    | 36   | 40   | 45   | 64   | 47   | 58   |
| 193 | 35      | 17 | 56.0 | 20                | 21    | 24   | 25   | 28   | 32   | 27   | 27   |
| 194 | 59      | 20 | 93.3 | 32                | 37    | 42   | 49   | 57   | 75   | 39   | 64   |
| 195 | 61      | 35 | 93.3 | 34                | 41    | 45   | 50   | 58   | 79   | 46   | 69   |
| 196 | 53      | 26 | 93.3 | 30                | 39    | 41   | 49   | 52   | 67   | 43   | 62   |
| 197 | 44      | 15 | 90.2 | 28                | 33    | 39   | 47   | 54   | 65   | 56   | 55   |
| 198 | 45      | 20 | 90.2 | 27                | 33    | 34   | 37   | 45   | 65   | 46   | 55   |
| 199 | 46      | 21 | 90.2 | 26                | 29    | 30   | 32   | 48   | 64   | 46   | 60   |
| 200 | 37      | 10 | 88.2 | 21                | 22    | 27   | 27   | 27   | 35   | 24   | 30   |
| 201 | 35      | 15 | 88.2 | 22                | 25    | 27   | 29   | 29   | 34   | 23   | 32   |
| 202 | 28      | 08 | 88.2 | 21                | 23    | 25   | 27   | 27   | 29   | 20   | 26   |
| 203 | 32      | 09 | 88.2 | 23                | 24    | 26   | 27   | 28   | 30   | 21   | 22   |
| 204 | 43      | 16 | 88.2 | 27                | 29    | 33   | 38   | 40   | 48   | 34   | 39   |

**AG = Age (years); YE = Years of exposure (years); NL = Noise level (dB)**

## DAILY EQUIVALENT NOISE LEVEL OF MACHINE AT THE QUARRIES

**Table D2: Noise level of machine at the quarry 1 [Q1]**

| <b>Day 1</b>             | <b>9am-<br/>10am</b> | <b>10am-<br/>11am</b> | <b>11am-<br/>12noon</b> | <b>12noon-<br/>1pm</b> | <b>1pm-<br/>2pm</b> | <b>2pm-<br/>3pm</b> | <b>3pm-<br/>4pm</b> | <b>4pm-<br/>5pm</b> |
|--------------------------|----------------------|-----------------------|-------------------------|------------------------|---------------------|---------------------|---------------------|---------------------|
| <b>Noise Level (dBA)</b> |                      |                       |                         |                        |                     |                     |                     |                     |
| Generator                | 96                   | 96                    | 96                      | 96                     | 96                  | 96                  | 96                  | 96                  |
| Primary Crusher          | 115                  | 115                   | 116                     | 117                    | 117                 | 117                 | 117                 | 117                 |
| Secondary Crusher        | 118                  | 118                   | 117                     | 116                    | 117                 | 117                 | 118                 | 118                 |
| Dumper                   | 96                   | 96                    | 96                      | 96                     | 96                  | 96                  | 96                  | 96                  |
| Compressor               | 112                  | 112                   | 114                     | 114                    | 114                 |                     |                     |                     |
| Wagon Drilling           | 95                   | 95                    | 95                      | 94                     | 94                  |                     |                     |                     |
| Pay loader               | 93                   | 94                    | 95                      | 95                     | 95                  | 95                  | 95                  | 95                  |
| Drilling Machine         | 89.4                 | 89.4                  | 89.5                    | 89.5                   | 89.6                | 89.2                | 89.4                | 89.4                |
| Lathe Machine            | 87.6                 | 87.4                  | 87.5                    | 87.4                   | 87.5                | 87.6                | 87.4                | 87.4                |
| Excavator                | 97.1                 | 97.1                  | 97.1                    | 97.5                   | 97.5                | 97.5                | 97.6                | 97.5                |
| <b>Leq</b>               | 120.5                | 120.5                 | 120.6                   | 120.7                  | 121.0               | 120.1               | 120.1               | 120.1               |
| <b>Day 2</b>             |                      |                       |                         |                        |                     |                     |                     |                     |
| Generator                | 95                   | 95                    | 95                      | 95                     | 95                  | 95                  | 95                  | 95                  |
| Primary Crusher          | 115                  | 115                   | 116                     | 116                    | 117                 | 117                 | 116                 | 117                 |
| Secondary Crusher        | 118                  | 118                   | 117                     | 117                    | 116                 | 117                 | 117                 | 118                 |
| Compressor               | 112                  | 112                   | 113                     | 114                    | 114                 | 114                 | 114                 | 114                 |
| Wagon Drilling           | 95                   | 95                    | 95                      | 94                     | 94                  | 95                  | 95                  | 95                  |
| Pay loader               | 92                   | 93                    | 93                      | 93                     | 94                  | 95                  | 95                  | 95                  |
| Drilling Machine         | 97.0                 | 97.0                  | 97.0                    | 97.3                   | 97.3                | 97.2                | 97.2                | 97.2                |
| Lathe Machine            | 88.1                 | 88.0                  | 88.1                    | 88.5                   | 88.5                | 88.5                | 88.6                | 88.5                |



|                   |       |       |       |       |       |       |       |       |
|-------------------|-------|-------|-------|-------|-------|-------|-------|-------|
| Excavator Machine | 97.0  | 97.0  | 97.1  | 97.2  | 97.2  | 97.5  | 97.4  | 97.5  |
| Leq               | 120.5 | 120.5 | 120.5 | 120.6 | 120.7 | 121.0 | 121.0 | 121.5 |

---

**Table D2 (Continued): Noise level of machine at the quarry 1 [Q1]**

|                   | <b>9am-<br/>10am</b>     | <b>10am-<br/>11am</b> | <b>11am-<br/>12noon</b> | <b>12noon-<br/>1pm</b> | <b>1pm-<br/>2pm</b> | <b>2pm-<br/>3pm</b> | <b>3pm-<br/>4pm</b> | <b>4pm-<br/>5pm</b> |
|-------------------|--------------------------|-----------------------|-------------------------|------------------------|---------------------|---------------------|---------------------|---------------------|
| <b>Day 3</b>      |                          |                       |                         |                        |                     |                     |                     |                     |
|                   | <b>Noise Level (dBA)</b> |                       |                         |                        |                     |                     |                     |                     |
| Generator         | 94                       | 94                    | 94                      | 95                     | 95                  | 95                  | 95                  | 95                  |
| Primary Crusher   | 114                      | 114                   | 115                     | 115                    | 115                 | 115                 | 115                 | 115                 |
| Secondary Crusher | 117                      | 117                   | 117                     | 117                    | 117                 | 118                 | 118                 | 118                 |
| Dumper            | 96                       | 96                    | 96                      | 96                     | 96                  | 96                  | 96                  | 96                  |
| Compressor        | 113                      | 113                   | 114                     | 114                    | 114                 | 114                 | 114                 | 114                 |
| Wagon Drilling    | 94                       | 94                    | 94                      | 94                     | 94                  | 94                  | 94                  | 94                  |
| Pay loader        | 92                       | 93                    | 93                      | 93                     | 94                  | 95                  | 95                  | 95                  |
| Drilling Machine  | 96.9                     | 96.9                  | 96.9                    | 97.0                   | 97.0                | 97.0                | 97.1                | 97.2                |
| Lathe Machine     | 87.5                     | 87.5                  | 87.5                    | 87.6                   | 87.6                | 87.7                | 87.7                | 87.7                |
| Excavator         | 97.1                     | 97.1                  | 97.1                    | 97.5                   | 97.5                | 97.5                | 97.6                | 97.6                |
| Leq               | 119.8                    | 119.8                 | 120.3                   | 120.3                  | 120.3               | 120.8               | 120.8               | 120.8               |
| <b>Day 4</b>      |                          |                       |                         |                        |                     |                     |                     |                     |
| Generator         | 92                       | 93                    | 93                      | 93                     | 93                  | 94                  | 94                  | 94                  |
| Primary Crusher   | 114                      | 114                   | 113                     | 114                    | 115                 | 115                 | 115                 | 115                 |
| Secondary Crusher | 116                      | 116                   | 117                     | 116                    | 117                 | 117                 | 117                 | 117                 |
| Dumper            | 94                       | 95                    | 95                      | 95                     | 94                  | 95                  | 95                  | 95                  |

|                  |       |       |       |       |       |       |       |       |
|------------------|-------|-------|-------|-------|-------|-------|-------|-------|
| Compressor       | 113   | 113   | 114   | 114   | 114   | 114   |       |       |
| Wagon Drilling   | 95    | 95    | 95    | 95    | 95    | 95    |       |       |
| Pay loader       | 91    | 91    | 91    | 92    | 93    | 93    | 94    | 94    |
| Drilling Machine | 97.0  | 97.0  | 97.0  | 97.0  | 97.0  | 97.0  | 97.0  | 97.0  |
| Lathe Machine    | 87.5  | 87.6  | 87.6  | 87.7  | 87.7  | 87.7  | 87.7  | 87.7  |
| Excavator        | 97.2  | 97.3  | 97.3  | 97.3  | 97.5  | 97.5  | 97.5  | 97.5  |
| Leq              | 119.3 | 119.3 | 119.8 | 119.6 | 120.3 | 120.3 | 119.2 | 119.2 |

---

**Table D2 (Continued): Noise level of machine at the quarry 1 [Q1]**

|                   | <b>9am-<br/>10am</b>     | <b>10am-<br/>11am</b> | <b>11am-<br/>12noon</b> | <b>12noon-<br/>1pm</b> | <b>1pm-<br/>2pm</b> | <b>2pm-<br/>3pm</b> | <b>3pm-<br/>4pm</b> | <b>4pm-<br/>5pm</b> |
|-------------------|--------------------------|-----------------------|-------------------------|------------------------|---------------------|---------------------|---------------------|---------------------|
| <b>Day 5</b>      | <b>Noise Level (dBA)</b> |                       |                         |                        |                     |                     |                     |                     |
| Generator         | 91                       | 92                    | 93                      | 93                     | 93                  | 93                  | 93                  | 93                  |
| Primary Crusher   | 113                      | 111                   | 112                     | 113                    | 114                 | 114                 | 114                 | 114                 |
| Secondary Crusher | 115                      | 115                   | 115                     | 116                    | 116                 | 117                 | 117                 | 117                 |
| Dumper            | 95                       | 95                    | 95                      | 95                     | 95                  | 95                  | 95                  | 95                  |
| Compressor        | 114                      | 113                   | 114                     | 113                    |                     |                     | 114                 | 114                 |
| Wagon Drilling    | 94                       | 93                    | 94                      | 94                     |                     |                     | 94                  | 94                  |
| Pay loader        | 90                       | 90                    | 89                      | 91                     | 91                  | 91                  |                     | 93                  |
| Drilling Machine  | 97.0                     | 97.0                  | 97.0                    | 97.1                   | 97.2                | 97.2                | 97.2                | 97.2                |
| Lathe Machine     | 87.1                     | 87.1                  | 87.2                    | 87.2                   | 87.3                | 87.3                | 87.3                | 87.3                |
| Excavator         | 97.2                     | 97.2                  | 97.3                    | 97.3                   | 97.3                | 97.3                | 97.3                | 97.3                |
| Leq               | 118.9                    | 118.1                 | 118.7                   | 119.1                  | 118.2               | 118.2               | 118.2               | 120.1               |

**Table D3: Noise level of machine at the quarry 2 [Q2]**

|                   | 9am-<br>10am             | 10am-<br>11am | 11am-<br>12noon | 12noon-<br>1pm | 1pm-<br>2pm | 2pm-<br>3pm | 3pm-<br>4pm | 4pm-<br>5pm |
|-------------------|--------------------------|---------------|-----------------|----------------|-------------|-------------|-------------|-------------|
| <b>Day 1</b>      | <b>Noise Level (dBA)</b> |               |                 |                |             |             |             |             |
| Generator         | 95                       | 95            | 96              | 96             | 99          | 98          | 99          | 93          |
| Primary Crusher   | 108                      | 108           | 111             | 111            | 112         | 113         | 113         | 113         |
| Secondary Crusher | 105                      | 105           | 106             | 107            | 107         | 108         | 108         | 108         |
| Dumper            | 94                       | 94            | 94              | 95             | 95          | 96          | 95          | 96          |
| Compressor        | 108                      | 109           | 108             |                | 108         |             | 109         | 108         |
| Wagon Drilling    | 90                       | 90            | 93              |                | 92          |             | 93          | 93          |
| Pay loader        | 89                       | 89            | 91              | 93             | 93          | 93          | 93          | 93          |
| Drilling Machine  | 97.1                     | 97.1          | 97.1            | 97.3           | 97.3        | 97.3        | 97.3        | 97.3        |
| Lathe Machine     | 86.5                     | 86.5          | 87.1            | 87.4           | 87.4        | 87.5        | 87.5        | 87.5        |
| Excavator         | 96.5                     | 96.5          | 97.1            | 97.2           | 97.2        | 97.2        | 97.2        | 97.2        |
| Leq               | 112.2                    | 112.2         | 113.8           | 112.7          | 114.6       | 114.4       | 115.5       | 115.3       |
| <b>Day 2</b>      |                          |               |                 |                |             |             |             |             |
| Generator         | 96                       | 96            | 97              | 97             | 97          | 98          | 99          | 99          |
| Primary Crusher   | 108                      | 107           | 109             | 109            | 111         | 110         | 112         | 112         |
| Secondary Crusher | 106                      | 106           | 107             | 108            | 108         | 109         | 109         | 109         |
| Dumper            | 94                       | 94            | 94              | 95             | 95          | 95          | 95          | 95          |
| Compressor        | 108                      | 108           | 108             | 108            | 108         | 108         | 109         | 109         |
| Wagon Drilling    | 90                       | 89            | 91              | 92             | 92          | 93          | 93          | 94          |

---

|                   |       |       |       |       |       |       |       |       |
|-------------------|-------|-------|-------|-------|-------|-------|-------|-------|
| Pay loader        | 89    | 89    | 91    | 93    | 92    | 93    | 93    | 93    |
| Drilling Machine  | 96.0  | 96.2  | 96.5  | 97.0  | 97.0  | 97.0  | 97.0  | 97.0  |
| Lathe Machine     | 87.4  | 87.4  | 87.5  | 87.5  | 87.5  | 87.5  | 87.5  | 87.5  |
| Excavator Machine | 96.8  | 96.7  | 96.8  | 97.1  | 97.1  | 97.1  | 97.1  | 97.1  |
| Leq               | 112.4 | 112.2 | 113.8 | 112.7 | 114.6 | 114.4 | 115.5 | 115.3 |

---

**Table D3 (Continued): Noise level of machine at the quarry 2 [Q2]**

|                   | <b>9am-<br/>10am</b>     | <b>10am-<br/>11am</b> | <b>11am-<br/>12noon</b> | <b>12noon-<br/>1pm</b> | <b>1pm-<br/>2pm</b> | <b>2pm-<br/>3pm</b> | <b>3pm-<br/>4pm</b> | <b>4pm-<br/>5pm</b> |
|-------------------|--------------------------|-----------------------|-------------------------|------------------------|---------------------|---------------------|---------------------|---------------------|
| <b>Day 3</b>      | <b>Noise Level (dBA)</b> |                       |                         |                        |                     |                     |                     |                     |
| Generator         | 98                       | 98                    | 98                      | 97                     | 97                  | 97                  | 98                  | 98                  |
| Primary Crusher   | 112                      | 112                   | 112                     | 112                    | 113                 | 113                 | 113                 | 113                 |
| Secondary Crusher | 107                      | 108                   | 108                     | 109                    | 110                 | 110                 | 111                 | 111                 |
| Dumper            | 94                       | 94                    | 93                      | 94                     | 93                  | 95                  | 96                  | 95                  |
| Compressor        | 108                      | 108                   |                         | 108                    | 109                 |                     | 108                 | 109                 |
| Wagon Drilling    | 90                       | 91                    |                         | 90                     | 91                  |                     | 92                  | 93                  |
| Pay loader        | 90                       | 90                    | 90                      | 93                     | 93                  | 92                  | 93                  | 92                  |
| Drilling Machine  | 97.0                     | 97.2                  | 97.2                    | 97.2                   | 97.2                | 97.2                | 97.2                | 97.2                |
| Lathe Machine     | 87.0                     | 87.2                  | 87.2                    | 87.2                   | 87.2                | 87.2                | 87.2                | 87.2                |
| Excavator Machine | 95.9                     | 95.9                  | 95.9                    | 95.9                   | 95.9                | 96.0                | 96.0                | 96.0                |
| Leq               | 114.5                    | 114.7                 | 113.6                   | 114.9                  | 115.9               | 114.9               | 116.0               | 116.2               |
| <b>Day 4</b>      |                          |                       |                         |                        |                     |                     |                     |                     |
| Generator         | 98                       | 98                    | 98                      | 97                     | 97                  | 97                  | 98                  | 98                  |
| Primary Crusher   | 113                      | 113                   | 114                     | 115                    | 115                 | 115                 | 115                 | 115                 |
| Secondary Crusher | 109                      | 108                   | 108                     | 110                    | 109                 | 110                 | 110                 | 110                 |
| Dumper            | 93                       | 93                    | 93                      | 94                     | 95                  | 95                  | 95                  | 95                  |
| Compressor        | 107                      | 108                   | 108                     | 108                    | 109                 | 109                 |                     |                     |
| Wagon Drilling    | 90                       | 90                    | 89                      | 90                     | 91                  | 92                  |                     |                     |

---

|                   |       |       |       |       |       |       |       |       |
|-------------------|-------|-------|-------|-------|-------|-------|-------|-------|
| Pay loader        | 91    | 90    | 90    | 90    | 92    | 93    | 93    | 92    |
| Drilling Machine  | 89.4  | 89.4  | 89.5  | 90.0  | 90.0  | 90.0  | 90.0  | 90.0  |
| Lathe Machine     | 87.0  | 87.5  | 87.5  | 87.5  | 87.5  | 87.5  | 87.5  | 87.5  |
| Excavator Machine | 97.0  | 97.1  | 97.1  | 97.1  | 97.1  | 97.1  | 97.1  | 97.1  |
| Leq               | 115.3 | 115.2 | 115.9 | 116.9 | 116.9 | 117.1 | 116.3 | 116.3 |

---



**Table D3 (Continued): Noise level of machine at the quarry 2 [Q2]**

|                   | <b>9am-<br/>10am</b>     | <b>10am-<br/>11am</b> | <b>11am-<br/>12noon</b> | <b>12noon-<br/>1pm</b> | <b>1pm-<br/>2pm</b> | <b>2pm-<br/>3pm</b> | <b>3pm-<br/>4pm</b> | <b>4pm-<br/>5pm</b> |
|-------------------|--------------------------|-----------------------|-------------------------|------------------------|---------------------|---------------------|---------------------|---------------------|
| <b>Day 5</b>      | <b>Noise Level (dBA)</b> |                       |                         |                        |                     |                     |                     |                     |
| Generator         | 97                       | 96                    | 97                      | 97                     | 96                  | 97                  | 97                  | 96                  |
| Primary Crusher   | 112                      | 113                   | 113                     | 114                    | 114                 | 115                 | 115                 | 114                 |
| Secondary Crusher | 109                      | 108                   | 108                     | 110                    | 111                 | 112                 | 113                 | 113                 |
| Dumper            | 94                       | 94                    | 95                      | 94                     | 94                  | 95                  | 95                  | 95                  |
| Compressor        | 108                      | 108                   | 108                     | 109                    | 109                 | 109                 | 109                 | 109                 |
| Wagon Drilling    | 90                       | 91                    | 89                      | 91                     | 90                  | 91                  | 91                  | 91                  |
| Pay loader        | 89                       | 88                    | 90                      | 92                     | 92                  | 92                  | 92                  | 92                  |
| Drilling Machine  | 96.8                     | 97.1                  | 97.0                    | 97.0                   | 97.1                | 97.1                | 97.0                | 97.0                |
| Lathe Machine     | 87.0                     | 87.1                  | 87.0                    | 87.0                   | 87.0                | 87.0                | 87.0                | 87.0                |
| Excavator         | 94.5                     | 94.5                  | 94.5                    | 95.0                   | 95.0                | 95.2                | 95.4                | 95.6                |
| Leq               | 114.9                    | 115.2                 | 115.3                   | 116.4                  | 116.7               | 117.5               | 117.8               | 117.3               |

**Table D4: Noise level of machine at the quarry 3 [Q3]**

|                   | <b>9am-<br/>10am</b>     | <b>10am-<br/>11am</b> | <b>11am-<br/>12noon</b> | <b>12noon-<br/>1pm</b> | <b>1pm-<br/>2pm</b> | <b>2pm-<br/>3pm</b> | <b>3pm-<br/>4pm</b> | <b>4pm-<br/>5pm</b> |
|-------------------|--------------------------|-----------------------|-------------------------|------------------------|---------------------|---------------------|---------------------|---------------------|
| <b>Day 1</b>      | <b>Noise Level (dBA)</b> |                       |                         |                        |                     |                     |                     |                     |
| Generator         | 91                       | 91                    | 92                      | 93                     | 93                  | 93                  | 92                  | 93                  |
| Primary Crusher   | 112                      | 112                   | 111                     | 112                    | 112                 | 114                 | 114                 | 114                 |
| Secondary Crusher | 114                      | 115                   | 114                     | 115                    | 114                 | 115                 | 115                 | 115                 |
| Dumper            | 93                       | 93                    | 93                      | 95                     | 95                  | 95                  | 94                  | 95                  |
| Compressor        | 112                      | 113                   | 112                     | 113                    | 112                 | 113                 | 113                 | 113                 |
| Wagon Drilling    | 93                       | 93                    | 92                      | 93                     | 93                  | 93                  | 93                  | 93                  |
| Pay loader        | 89                       | 91                    | 91                      | 92                     | 92                  | 92                  | 92                  | 93                  |
| Drilling Machine  | 97.8                     | 97.8                  | 97.8                    | 98.0                   | 98.0                | 98.0                | 98.0                | 98.0                |
| Lathe Machine     | 89.0                     | 89.0                  | 89.0                    | 89.0                   | 89.0                | 89.0                | 89.0                | 89.0                |
| Excavator         | 98.0                     | 98.0                  | 98.0                    | 98.0                   | 98.0                | 98.0                | 98.0                | 98.0                |
| Leq               | 117.6                    | 118.3                 | 117.3                   | 118.3                  | 117.6               | 118.9               | 118.9               | 118.9               |
| <b>Day 2</b>      |                          |                       |                         |                        |                     |                     |                     |                     |
| Generator         | 90                       | 91                    | 91                      | 92                     | 93                  | 92                  | 93                  | 93                  |
| Primary Crusher   | 111                      | 111                   | 111                     | 111                    | 113                 | 113                 | 114                 | 114                 |
| Secondary Crusher | 115                      | 115                   | 115                     | 115                    | 115                 | 115                 | 115                 | 115                 |
| Dumper            | 92                       | 92                    | 93                      | 94                     | 95                  | 95                  | 95                  | 95                  |
| Compressor        | 112                      | 112                   | 112                     | 113                    | 113                 | 113                 | 114                 | 113                 |
| Wagon Drilling    | 92                       | 92                    | 92                      | 92                     | 93                  | 93                  | 93                  | 93                  |

---

|                   |       |       |       |       |       |       |       |       |
|-------------------|-------|-------|-------|-------|-------|-------|-------|-------|
| Pay loader        | 90    | 92    | 93    | 93    | 93    | 93    | 93    | 93    |
| Drilling Machine  | 97.0  | 97.0  | 97.0  | 97.0  | 97.0  | 97.0  | 97.0  | 97.0  |
| Lathe Machine     | 88.0  | 88.0  | 88.0  | 88.0  | 88.0  | 88.0  | 88.0  | 88.0  |
| Excavator Machine | 97.3  | 97.3  | 97.3  | 97.5  | 97.5  | 97.5  | 97.5  | 97.5  |
| Leq               | 117.8 | 117.8 | 117.8 | 118.1 | 118.6 | 118.6 | 119.2 | 119.2 |

---

**Table D4 (Continued): Noise level of machine at the quarry 3 [Q3]**

|                   | <b>9am-<br/>10am</b>     | <b>10am-<br/>11am</b> | <b>11am-<br/>12noon</b> | <b>12noon-<br/>1pm</b> | <b>1pm-<br/>2pm</b> | <b>2pm-<br/>3pm</b> | <b>3pm-<br/>4pm</b> | <b>4pm-<br/>5pm</b> |
|-------------------|--------------------------|-----------------------|-------------------------|------------------------|---------------------|---------------------|---------------------|---------------------|
| <b>Day 3</b>      | <b>Noise Level (dBA)</b> |                       |                         |                        |                     |                     |                     |                     |
| Generator         | 96                       | 96                    | 97                      | 97                     | 97                  | 98                  | 99                  | 99                  |
| Primary Crusher   | 114                      | 114                   | 115                     | 115                    | 115                 | 115                 | 115                 | 115                 |
| Secondary Crusher | 116                      | 116                   | 116                     | 114                    | 114                 | 115                 | 115                 | 115                 |
| Dumper            | 93                       | 93                    | 93                      | 95                     | 95                  | 95                  | 95                  | 95                  |
| Compressor        | 113                      | 113                   | 113                     | 114                    | 114                 | 114                 | 114                 | 114                 |
| Wagon Drilling    | 92                       | 92                    | 92                      | 92                     | 92                  | 93                  | 93                  | 93                  |
| Pay loader        | 90                       | 93                    | 94                      | 94                     | 95                  | 95                  | 95                  | 95                  |
| Drilling Machine  | 97.0                     | 97.0                  | 97.0                    | 97.0                   | 97.0                | 97.0                | 97.0                | 97.0                |
| Lathe Machine     | 88.0                     | 88.0                  | 88.2                    | 88.2                   | 88.5                | 88.5                | 88.5                | 88.5                |
| Excavator Machine | 97.1                     | 97.1                  | 97.1                    | 97.1                   | 97.1                | 97.1                | 97.1                | 97.1                |
| Leq               | 119.3                    | 119.3                 | 119.6                   | 119.2                  | 119.2               | 119.5               | 119.5               | 119.5               |
| <b>Day 4</b>      |                          |                       |                         |                        |                     |                     |                     |                     |
| Generator         | 92                       | 92                    | 92                      | 94                     | 95                  | 95                  | 96                  | 96                  |
| Primary Crusher   | 114                      | 114                   | 115                     | 116                    | 116                 | 116                 | 116                 | 116                 |
| Secondary Crusher | 115                      | 115                   | 115                     | 115                    | 115                 | 115                 | 115                 | 115                 |
| Dumper            | 92                       | 92                    | 93                      | 93                     | 94                  | 93                  | 93                  | 93                  |
| Compressor        | 112                      | 112                   | 112                     | 113                    | 114                 | 113                 | 113                 | 114                 |
| Wagon Drilling    | 90                       | 92                    | 93                      | 92                     | 93                  | 93                  | 93                  | 93                  |

---

|                   |       |       |       |       |       |       |       |       |
|-------------------|-------|-------|-------|-------|-------|-------|-------|-------|
| Pay loader        | 90    | 90    | 90    | 94    | 95    | 95    | 95    | 95    |
| Drilling Machine  | 97.0  | 97.1  | 97.1  | 97.1  | 97.1  | 97.1  | 97.1  | 97.1  |
| Lathe Machine     | 87.5  | 87.5  | 87.5  | 87.5  | 87.5  | 87.5  | 87.5  | 87.5  |
| Excavator Machine | 97.0  | 97.0  | 97.0  | 97.0  | 97.0  | 97.0  | 97.0  | 97.0  |
| Leq               | 118.6 | 118.6 | 119.0 | 119.6 | 119.9 | 119.7 | 119.7 | 119.7 |

---

**Table D4 (Continued): Noise level of machine at the quarry 3 [Q3]**

|                   | <b>9am-<br/>10am</b>     | <b>10am-<br/>11am</b> | <b>11am-<br/>12noon</b> | <b>12noon-<br/>1pm</b> | <b>1pm-<br/>2pm</b> | <b>2pm-<br/>3pm</b> | <b>3pm-<br/>4pm</b> | <b>4pm-<br/>5pm</b> |
|-------------------|--------------------------|-----------------------|-------------------------|------------------------|---------------------|---------------------|---------------------|---------------------|
| <b>Day 5</b>      | <b>Noise Level (dBA)</b> |                       |                         |                        |                     |                     |                     |                     |
| Generator         | 90                       | 93                    | 95                      | 95                     | 96                  | 96                  | 97                  | 98                  |
| Primary Crusher   | 116                      | 116                   | 116                     | 117                    | 117                 | 117                 | 117                 | 117                 |
| Secondary Crusher | 115                      | 114                   | 115                     | 115                    | 115                 | 115                 | 115                 | 115                 |
| Dumper            | 94                       | 94                    | 94                      | 94                     | 95                  | 95                  | 95                  | 94                  |
| Compressor        | 110                      | 112                   | 113                     | 112                    | 114                 | 114                 | 115                 | 115                 |
| Wagon Drilling    | 90                       | 92                    | 93                      | 92                     | 90                  | 91                  | 92                  | 91                  |
| Pay loader        | 90                       | 90                    | 94                      | 94                     | 94                  | 94                  | 95                  | 95                  |
| Drilling Machine  | 97.0                     | 97.0                  | 97.0                    | 97.0                   | 97.1                | 97.1                | 97.1                | 97.1                |
| Lathe Machine     | 87.5                     | 87.5                  | 87.5                    | 87.5                   | 87.5                | 87.5                | 87.5                | 87.5                |
| Excavator         | 97.0                     | 97.0                  | 97.0                    | 97.0                   | 97.0                | 97.0                | 97.0                | 97.0                |
| Leq               | 119.1                    | 119.1                 | 119.7                   | 119.9                  | 120.3               | 120.3               | 120.6               | 120.6               |

**Table D5: Noise level of machine at the quarry 4 [Q4]**

|                   | <b>9am-<br/>10am</b>     | <b>10am-<br/>11am</b> | <b>11am-<br/>12noon</b> | <b>12noon-<br/>1pm</b> | <b>1pm-<br/>2pm</b> | <b>2pm-<br/>3pm</b> | <b>3pm-<br/>4pm</b> | <b>4pm-<br/>5pm</b> |
|-------------------|--------------------------|-----------------------|-------------------------|------------------------|---------------------|---------------------|---------------------|---------------------|
| <b>Day 1</b>      | <b>Noise Level (dBA)</b> |                       |                         |                        |                     |                     |                     |                     |
| Generator         | 97                       | 99                    | 100                     | 102                    | 101                 | 102                 | 103                 | 103                 |
| Primary Crusher   | 113                      | 114                   | 114                     | 115                    | 115                 | 115                 | 116                 | 115                 |
| Secondary Crusher | 110                      | 112                   | 112                     | 113                    | 114                 | 113                 | 112                 | 113                 |
| Dumper            | 97                       | 97                    | 97                      | 97                     | 97                  | 97                  | 97                  | 97                  |
| Compressor        | 100                      | 100                   | 102                     | 102                    | 103                 | 103                 | 102                 | 102                 |
| Wagon Drilling    | 88                       | 89                    | 99                      | 98                     | 99                  | 100                 | 100                 | 101                 |
| Pay loader        | 90                       | 92                    | 92                      | 93                     | 94                  | 94                  | 96                  | 99                  |
| Drilling Machine  | 90.1                     | 90.2                  | 90.2                    | 90.2                   | 90.2                | 90.2                | 90.2                | 90.2                |
| Lathe Machine     | 87.4                     | 87.4                  | 87.4                    | 87.4                   | 87.4                | 87.4                | 87.4                | 87.4                |
| Excavator         | 95.0                     | 95.2                  | 95.2                    | 95.2                   | 95.2                | 95.2                | 95.2                | 95.2                |
| Leq               | 115.1                    | 116.4                 | 116.5                   | 117.5                  | 117.9               | 117.6               | 117.9               | 117.6               |
| <b>Day 2</b>      |                          |                       |                         |                        |                     |                     |                     |                     |
| Generator         | 98                       | 100                   | 100                     | 101                    | 103                 | 103                 | 102                 | 103                 |
| Primary Crusher   | 114                      | 115                   | 114                     | 116                    | 115                 | 116                 | 114                 | 115                 |
| Secondary Crusher | 110                      | 112                   | 112                     | 113                    | 112                 | 113                 | 112                 | 113                 |
| Dumper            | 96                       | 96                    | 97                      | 97                     | 96                  | 96                  | 97                  | 97                  |
| Compressor        | 99                       | 100                   | 102                     | 102                    | 103                 | 102                 | 102                 | 102                 |
| Wagon Drilling    | 87                       | 99                    | 98                      | 99                     | 100                 | 99                  | 100                 | 99                  |

---

|                   |       |       |       |       |       |       |       |       |
|-------------------|-------|-------|-------|-------|-------|-------|-------|-------|
| Pay loader        | 89    | 90    | 94    | 96    | 98    | 94    | 96    | 99    |
| Drilling Machine  | 90.2  | 90.2  | 90.2  | 90.2  | 90.2  | 90.2  | 90.2  | 90.2  |
| Lathe Machine     | 87.5  | 87.5  | 87.5  | 87.5  | 87.5  | 87.6  | 87.6  | 87.6  |
| Excavator Machine | 95.0  | 95.2  | 95.2  | 95.2  | 95.2  | 95.2  | 95.2  | 95.2  |
| Leq               | 115.7 | 117.7 | 116.5 | 118.1 | 117.3 | 118.1 | 116.6 | 117.6 |

---



**Table D5 (Continued): Noise level of machine at the quarry 4 [Q4]**

|                   | <b>9am-<br/>10am</b>     | <b>10am-<br/>11am</b> | <b>11am-<br/>12noon</b> | <b>12noon-<br/>1pm</b> | <b>1pm-<br/>2pm</b> | <b>2pm-<br/>3pm</b> | <b>3pm-<br/>4pm</b> | <b>4pm-<br/>5pm</b> |
|-------------------|--------------------------|-----------------------|-------------------------|------------------------|---------------------|---------------------|---------------------|---------------------|
| <b>Day 3</b>      | <b>Noise Level (dBA)</b> |                       |                         |                        |                     |                     |                     |                     |
| Generator         | 98                       | 100                   | 100                     | 101                    | 102                 | 102                 | 101                 | 101                 |
| Primary Crusher   | 113                      | 113                   | 113                     | 114                    | 115                 | 116                 | 113                 | 113                 |
| Secondary Crusher | 111                      | 111                   | 111                     | 111                    | 112                 | 113                 | 114                 | 114                 |
| Dumper            | 95                       | 96                    | 96                      | 96                     | 96                  | 96                  | 96                  | 97                  |
| Compressor        | 101                      | 101                   | 101                     | 101                    | 102                 | 102                 | 101                 | 102                 |
| Wagon Drilling    | 88                       | 98                    | 98                      | 99                     | 100                 | 102                 | 102                 | 102                 |
| Pay loader        | 90                       | 92                    | 92                      | 92                     | 93                  | 93                  | 94                  | 94                  |
| Drilling Machine  | 90.2                     | 90.2                  | 90.2                    | 90.2                   | 90.2                | 90.2                | 90.2                | 90.2                |
| Lathe Machine     | 87.5                     | 87.5                  | 87.5                    | 87.5                   | 87.5                | 87.5                | 87.5                | 87.5                |
| Excavator Machine | 95.0                     | 95.0                  | 95.0                    | 95.0                   | 95.0                | 95.0                | 95.0                | 95.0                |
| Leq               | 115.4                    | 115.6                 | 115.6                   | 116.2                  | 117.2               | 118.1               | 117.0               | 117.0               |
| <b>Day 4</b>      |                          |                       |                         |                        |                     |                     |                     |                     |
| Generator         | 98                       | 100                   | 101                     | 102                    | 104                 | 104                 | 103                 | 102                 |
| Primary Crusher   | 112                      | 112                   | 114                     | 115                    | 115                 | 114                 | 115                 | 114                 |
| Secondary Crusher | 110                      | 110                   | 112                     | 113                    | 114                 | 115                 | 112                 | 113                 |
| Dumper            | 96                       | 96                    | 96                      | 96                     | 97                  | 96                  | 97                  | 96                  |
| Compressor        | 100                      | 99                    | 101                     | 101                    | 103                 | 103                 | 103                 | 103                 |
| Wagon Drilling    | 87                       | 98                    | 98                      | 98                     | 100                 | 102                 | 101                 | 102                 |

---

|                   |       |       |       |       |       |       |       |       |
|-------------------|-------|-------|-------|-------|-------|-------|-------|-------|
| Pay loader        | 90    | 91    | 89    | 94    | 90    | 88    | 94    | 94    |
| Drilling Machine  | 89.2  | 89.2  | 90.1  | 90.2  | 90.2  | 90.2  | 90.2  | 90.2  |
| Lathe Machine     | 88.0  | 88.0  | 88.1  | 88.1  | 88.1  | 88.1  | 88.1  | 88.2  |
| Excavator Machine | 95.0  | 95.0  | 95.0  | 95.0  | 95.0  | 95.0  | 95.0  | 95.0  |
| Leq               | 114.5 | 114.6 | 116.5 | 117.5 | 118.0 | 118.0 | 117.3 | 117.1 |

---

**Table D5 (Continued): Noise level of machine at the quarry 4 [Q4]**

|                   | <b>9am-<br/>10am</b>     | <b>10am-<br/>11am</b> | <b>11am-<br/>12noon</b> | <b>12noon-<br/>1pm</b> | <b>1pm-<br/>2pm</b> | <b>2pm-<br/>3pm</b> | <b>3pm-<br/>4pm</b> | <b>4pm-<br/>5pm</b> |
|-------------------|--------------------------|-----------------------|-------------------------|------------------------|---------------------|---------------------|---------------------|---------------------|
| <b>Day 5</b>      | <b>Noise Level (dBA)</b> |                       |                         |                        |                     |                     |                     |                     |
| Generator         | 99                       | 100                   | 101                     | 101                    | 104                 | 104                 | 103                 | 103                 |
| Primary Crusher   | 114                      | 115                   | 116                     | 115                    | 116                 | 116                 | 114                 | 115                 |
| Secondary Crusher | 111                      | 111                   | 112                     | 112                    | 113                 | 113                 | 112                 | 112                 |
| Dumper            | 97                       | 97                    | 97                      | 97                     | 97                  | 96                  | 96                  | 96                  |
| Compressor        | 99                       | 100                   | 102                     | 103                    | 103                 | 103                 | 103                 | 103                 |
| Wagon Drilling    | 88                       | 99                    | 99                      | 100                    | 102                 | 101                 | 104                 | 99                  |
| Pay loader        | 89                       | 91                    | 94                      | 96                     | 97                  | 94                  | 96                  | 99                  |
| Drilling Machine  | 89                       | 89                    | 89                      | 90                     | 90                  | 90                  | 90                  | 90                  |
| Lathe Machine     | 88.5                     | 88.5                  | 88.5                    | 88.5                   | 88.5                | 88.5                | 86.0                | 86.0                |
| Excavator         | 97.1                     | 97.1                  | 97.1                    | 97.1                   | 97.5                | 97.5                | 97.5                | 97.5                |
| Leq               | 116.0                    | 116.8                 | 117.8                   | 117.2                  | 118.3               | 118.2               | 116.8               | 117.3               |

## SUMMARY OF THE AVERAGE NOISE LEVEL IN THE QUARRIES

**Table D6: Summary of the Average Noise Level in Q1**

| <b>Days</b>             | <b>L<sub>eq</sub> (dB)</b> |
|-------------------------|----------------------------|
| 1                       | 120.3                      |
| 2                       | 120.8                      |
| 3                       | 120.4                      |
| 4                       | 119.6                      |
| 5                       | 118.9                      |
| Average L <sub>eq</sub> | 120.0                      |

**Table D7: Summary of the Average Noise Level in Q2**

| <b>Days</b>             | <b>L<sub>eq</sub> (dB)</b> |
|-------------------------|----------------------------|
| 1                       | 113.8                      |
| 2                       | 113.7                      |
| 3                       | 115.1                      |
| 4                       | 116.2                      |
| 5                       | 116.4                      |
| Average L <sub>eq</sub> | 115.0                      |

**Table D8: Summary of the Average Noise Level in Q3**

| <b>Days</b>             | <b>L<sub>eq</sub> (dB)</b> |
|-------------------------|----------------------------|
| 1                       | 118.2                      |
| 2                       | 118.4                      |
| 3                       | 119.4                      |
| 4                       | 119.4                      |
| 5                       | 120.0                      |
| Average L <sub>eq</sub> | 119.1                      |

**Table D9: Summary of the Average Noise Level in Q4**

| <b>Days</b>             | <b>L<sub>eq</sub> (dB)</b> |
|-------------------------|----------------------------|
| 1                       | 117.1                      |
| 2                       | 117.2                      |
| 3                       | 116.5                      |
| 4                       | 116.7                      |
| 5                       | 117.3                      |
| Average L <sub>eq</sub> | 117.0                      |

**APPENDIX E**  
**2019 EXPERIMENT**

**Table E1: Age, Years of Exposure, Noise level and Hearing Threshold of the Quarry Workers in the year 2019.**

| No         | FACTORS |    |       | HEARING THRESHOLD (dB) |       |      |      |      |      |      |      |
|------------|---------|----|-------|------------------------|-------|------|------|------|------|------|------|
|            | AG      | YE | NL    | 250Hz                  | 500Hz | 1kHz | 2kHz | 3kHz | 4kHz | 6kHz | 8kHz |
| 1.         | 53      | 27 | 115   | 38                     | 49    | 57   | 60   | 64   | 86   | 75   | 77   |
| 2.         | 57      | 34 | 115   | 36                     | 51    | 69   | 70   | 71   | 95   | 79   | 77   |
| 3.         | 57      | 27 | 115   | 35                     | 49    | 50   | 64   | 77   | 94   | 75   | 79   |
| 4.         | 51      | 20 | 115   | 29                     | 42    | 43   | 44   | 50   | 68   | 51   | 65   |
| 5.         | 43      | 22 | 116.6 | 34                     | 36    | 37   | 41   | 50   | 57   | 47   | 60   |
| <b>*6.</b> |         |    |       |                        |       |      |      |      |      |      |      |
| 7.         | 64      | 36 | 116.9 | 36                     | 57    | 60   | 69   | 74   | 95   | 71   | 82   |
| 8.         | 50      | 23 | 116.6 | 30                     | 34    | 35   | 38   | 47   | 69   | 53   | 67   |
| 9.         | 52      | 19 | 116.9 | 31                     | 38    | 39   | 45   | 48   | 65   | 50   | 60   |
| 10.        | 53      | 14 | 113.5 | 33                     | 35    | 35   | 38   | 42   | 68   | 46   | 65   |
| 11.        | 48      | 21 | 113.5 | 31                     | 32    | 39   | 43   | 44   | 55   | 57   | 62   |
| 12.        | 36      | 14 | 113.5 | 26                     | 26    | 29   | 31   | 37   | 38   | 39   | 42   |
| 13.        | 59      | 26 | 113.5 | 29                     | 36    | 43   | 53   | 61   | 69   | 50   | 64   |
| 14.        | 27      | 08 | 96    | 19                     | 21    | 22   | 25   | 27   | 28   | 25   | 30   |
| 15.        | 46      | 20 | 96    | 25                     | 30    | 34   | 35   | 36   | 57   | 39   | 45   |
| 16.        | 35      | 16 | 96    | 26                     | 31    | 35   | 35   | 38   | 54   | 36   | 39   |
| 17.        | 50      | 23 | 96    | 28                     | 27    | 36   | 39   | 42   | 59   | 40   | 43   |
| <b>*18</b> |         |    |       |                        |       |      |      |      |      |      |      |
| 19.        | 41      | 21 | 94.4  | 27                     | 31    | 39   | 44   | 46   | 60   | 44   | 48   |
| 20.        | 31      | 12 | 94.4  | 24                     | 27    | 29   | 30   | 31   | 32   | 27   | 34   |
| <b>*21</b> |         |    |       |                        |       |      |      |      |      |      |      |
| 22.        | 28      | 07 | 94.4  | 17                     | 21    | 23   | 29   | 31   | 32   | 26   | 31   |
| 23.        | 40      | 15 | 94.4  | 23                     | 25    | 29   | 29   | 33   | 59   | 36   | 38   |
| 24.        | 44      | 22 | 94.4  | 26                     | 29    | 39   | 42   | 44   | 60   | 37   | 41   |
| 25.        | 39      | 20 | 94.4  | 24                     | 31    | 33   | 37   | 44   | 54   | 40   | 43   |
| 26.        | 33      | 12 | 93.1  | 25                     | 28    | 34   | 35   | 37   | 56   | 31   | 35   |

**Table E1 (Continued): Age, Years of Exposure, Noise level and Hearing Threshold of the Quarry Workers in the year 2019.**

| No          | FACTORS |    |       | HEARING THRESHOLD (dB) |       |      |      |      |      |      |      |
|-------------|---------|----|-------|------------------------|-------|------|------|------|------|------|------|
|             | AG      | YE | NL    | 250Hz                  | 500Hz | 1kHz | 2kHz | 3kHz | 4kHz | 6kHz | 8kHz |
| 27          | 37      | 26 | 93.1  | 25                     | 31    | 36   | 37   | 45   | 57   | 61   | 56   |
| 28          | 45      | 25 | 93.1  | 28                     | 33    | 34   | 38   | 51   | 53   | 40   | 45   |
| 29          | 42      | 20 | 93.1  | 29                     | 29    | 35   | 39   | 42   | 63   | 47   | 64   |
| <b>*30</b>  |         |    |       |                        |       |      |      |      |      |      |      |
| 31          | 55      | 24 | 93.1  | 37                     | 39    | 48   | 53   | 67   | 96   | 77   | 86   |
| 32          | 49      | 21 | 93.1  | 33                     | 34    | 37   | 43   | 57   | 70   | 49   | 64   |
| 33          | 25      | 07 | 93.0  | 19                     | 22    | 25   | 27   | 29   | 29   | 26   | 30   |
| 34          | 38      | 15 | 93.0  | 23                     | 25    | 26   | 31   | 33   | 37   | 32   | 33   |
| <b>*35</b>  |         |    |       |                        |       |      |      |      |      |      |      |
| 36          | 55      | 30 | 88.3  | 32                     | 38    | 42   | 48   | 59   | 98   | 79   | 67   |
| 37          | 46      | 20 | 88.3  | 33                     | 41    | 42   | 46   | 53   | 69   | 59   | 65   |
| 38          | 61      | 36 | 97.3  | 36                     | 39    | 45   | 47   | 55   | 94   | 84   | 77   |
| 39          | 22      | 04 | 45    | 25                     | 22    | 22   | 23   | 23   | 25   | 22   | 23   |
| <b>*40</b>  |         |    |       |                        |       |      |      |      |      |      |      |
| 41          | 26      | 08 | 112.3 | 24                     | 25    | 26   | 27   | 29   | 30   | 28   | 31   |
| 42.         | 37      | 14 | 112.3 | 21                     | 23    | 28   | 32   | 36   | 39   | 36   | 36   |
| 43.         | 31      | 09 | 112.3 | 23                     | 25    | 26   | 27   | 28   | 39   | 28   | 31   |
| 44.         | 32      | 14 | 112.3 | 24                     | 25    | 29   | 29   | 30   | 35   | 33   | 32   |
| 45.         | 48      | 26 | 112.3 | 35                     | 36    | 40   | 45   | 49   | 68   | 68   | 40   |
| 46.         | 52      | 27 | 112.3 | 28                     | 34    | 43   | 49   | 59   | 77   | 72   | 66   |
| 47.         | 54      | 31 | 112.3 | 28                     | 33    | 44   | 47   | 53   | 95   | 61   | 64   |
| 48.         | 36      | 14 | 108.3 | 22                     | 26    | 34   | 43   | 45   | 46   | 41   | 42   |
| 49.         | 22      | 04 | 108.3 | 18                     | 21    | 23   | 26   | 28   | 30   | 24   | 29   |
| <b>*50.</b> |         |    |       |                        |       |      |      |      |      |      |      |
| 51.         | 52      | 25 | 94.5  | 34                     | 38    | 43   | 48   | 58   | 92   | 58   | 64   |
| 52.         | 49      | 24 | 94.5  | 28                     | 36    | 40   | 47   | 51   | 70   | 45   | 51   |
| 53.         | 44      | 20 | 94.5  | 34                     | 33    | 57   | 47   | 59   | 67   | 48   | 53   |
| 54.         | 42      | 21 | 94.5  | 28                     | 29    | 35   | 47   | 51   | 71   | 54   | 49   |
| 55.         | 25      | 07 | 94.5  | 21                     | 22    | 23   | 24   | 27   | 29   | 26   | 29   |



**Table E1 (Continued): Age, Years of Exposure, Noise level and Hearing Threshold of the Quarry Workers in the year 2019.**

| No  | FACTORS |    |      | HEARING THRESHOLD (dB) |       |      |      |      |      |      |      |
|-----|---------|----|------|------------------------|-------|------|------|------|------|------|------|
|     | AG      | YE | NL   | 250Hz                  | 500Hz | 1kHz | 2kHz | 3kHz | 4kHz | 6kHz | 8kHz |
| 56. | 36      | 13 | 91.1 | 24                     | 26    | 27   | 31   | 36   | 54   | 39   | 30   |
| 57. | 30      | 08 | 91.1 | 23                     | 24    | 25   | 26   | 28   | 29   | 26   | 28   |
| 58. | 31      | 13 | 91.1 | 23                     | 24    | 27   | 29   | 31   | 31   | 30   | 31   |
| 59. | 35      | 15 | 91.1 | 29                     | 32    | 34   | 39   | 37   | 41   | 35   | 31   |
| 60. | 29      | 11 | 91.1 | 20                     | 23    | 25   | 26   | 28   | 29   | 27   | 28   |
| 61. | 53      | 30 | 91.1 | 32                     | 34    | 44   | 50   | 54   | 80   | 51   | 73   |
| 62. | 35      | 14 | 91.5 | 23                     | 24    | 26   | 26   | 28   | 31   | 28   | 31   |
| 63. | 21      | 03 | 91.5 | 18                     | 20    | 22   | 23   | 26   | 29   | 25   | 27   |
| 64. | 35      | 14 | 91.5 | 22                     | 23    | 23   | 27   | 29   | 31   | 28   | 32   |
| 65. | 51      | 25 | 91.5 | 36                     | 37    | 44   | 45   | 57   | 70   | 49   | 64   |
| 66. | 48      | 27 | 91.5 | 30                     | 32    | 40   | 45   | 53   | 79   | 59   | 75   |
| 67. | 53      | 30 | 91.5 | 34                     | 37    | 39   | 50   | 57   | 88   | 71   | 76   |
| 68  | 49      | 23 | 91.5 | 36                     | 37    | 43   | 51   | 59   | 68   | 57   | 61   |
| 69  | 41      | 21 | 97.2 | 24                     | 41    | 45   | 52   | 57   | 67   | 56   | 60   |
| 70  | 46      | 20 | 97.2 | 30                     | 38    | 41   | 48   | 59   | 71   | 48   | 66   |
| 71  | 35      | 13 | 97.2 | 23                     | 25    | 28   | 30   | 31   | 33   | 27   | 31   |
| 72  | 51      | 29 | 97.2 | 31                     | 37    | 43   | 56   | 70   | 75   | 65   | 72   |
| 73  | 49      | 22 | 87.3 | 28                     | 33    | 38   | 45   | 57   | 79   | 65   | 73   |
| 74  | 41      | 15 | 87.3 | 27                     | 30    | 34   | 37   | 43   | 58   | 52   | 56   |
| 75  | 30      | 07 | 87.3 | 24                     | 26    | 27   | 28   | 35   | 36   | 28   | 33   |
| 76  | 52      | 29 | 87.3 | 37                     | 41    | 45   | 51   | 70   | 90   | 77   | 82   |
| 77  | 53      | 34 | 93.2 | 38                     | 44    | 49   | 55   | 60   | 98   | 67   | 83   |
| 78  | 34      | 13 | 93.2 | 22                     | 24    | 26   | 29   | 30   | 33   | 31   | 34   |
| 79  | 36      | 15 | 93.2 | 21                     | 25    | 29   | 30   | 31   | 36   | 34   | 35   |
| 80  | 39      | 14 | 30.2 | 22                     | 23    | 26   | 28   | 29   | 31   | 27   | 30   |
| 81  | 42      | 12 | 37.8 | 24                     | 23    | 24   | 36   | 37   | 42   | 28   | 40   |
| 82  | 38      | 13 | 44.3 | 22                     | 23    | 25   | 27   | 28   | 32   | 28   | 31   |
| 83  | 38      | 16 | 49.3 | 23                     | 25    | 26   | 28   | 34   | 35   | 27   | 31   |

**Table E1 (Continued): Age, Years of Exposure, Noise level and Hearing Threshold of the Quarry Workers in the year 2019.**

| No          | FACTORS |    |       | HEARING THRESHOLD (dB) |       |      |      |      |      |      |      |
|-------------|---------|----|-------|------------------------|-------|------|------|------|------|------|------|
|             | AG      | YE | NL    | 250Hz                  | 500Hz | 1kHz | 2kHz | 3kHz | 4kHz | 6kHz | 8kHz |
| 84          | 35      | 19 | 28.4  | 24                     | 27    | 29   | 32   | 33   | 38   | 33   | 32   |
| 85          | 36      | 11 | 38.4  | 22                     | 23    | 24   | 26   | 29   | 32   | 28   | 30   |
| 86          | 30      | 11 | 50.0  | 24                     | 23    | 27   | 29   | 34   | 36   | 32   | 33   |
| 87          | 35      | 16 | 114.3 | 27                     | 27    | 28   | 29   | 33   | 34   | 30   | 32   |
| 88          | 36      | 13 | 114.3 | 24                     | 26    | 27   | 28   | 32   | 33   | 30   | 33   |
| <b>*89</b>  |         |    |       |                        |       |      |      |      |      |      |      |
| 90          | 33      | 07 | 114.3 | 23                     | 24    | 25   | 27   | 29   | 31   | 27   | 30   |
| 91          | 39      | 20 | 114.3 | 22                     | 25    | 32   | 32   | 33   | 37   | 30   | 34   |
| 92          | 52      | 23 | 114.3 | 39                     | 45    | 49   | 57   | 63   | 87   | 62   | 84   |
| 93          | 39      | 08 | 114.9 | 22                     | 23    | 25   | 26   | 27   | 28   | 25   | 29   |
| <b>*94</b>  |         |    |       |                        |       |      |      |      |      |      |      |
| 95          | 19      | 04 | 114.9 | 20                     | 22    | 24   | 26   | 30   | 33   | 29   | 31   |
| 96          | 45      | 13 | 114.9 | 26                     | 29    | 29   | 27   | 29   | 34   | 30   | 35   |
| 97          | 40      | 15 | 114.9 | 27                     | 33    | 35   | 38   | 40   | 46   | 44   | 49   |
| 98          | 42      | 20 | 113   | 24                     | 27    | 46   | 48   | 60   | 71   | 48   | 66   |
| 99          | 37      | 18 | 113   | 20                     | 24    | 27   | 27   | 31   | 30   | 29   | 32   |
| <b>*100</b> |         |    |       |                        |       |      |      |      |      |      |      |
| 101         | 45      | 21 | 113   | 29                     | 33    | 35   | 35   | 36   | 40   | 32   | 38   |
| 102         | 40      | 15 | 113   | 28                     | 32    | 33   | 36   | 37   | 40   | 39   | 43   |
| 103         | 42      | 22 | 113   | 29                     | 33    | 35   | 37   | 38   | 42   | 38   | 40   |
| 104         | 52      | 25 | 113   | 30                     | 32    | 36   | 43   | 55   | 68   | 46   | 59   |
| 105         | 28      | 10 | 113   | 20                     | 22    | 25   | 28   | 29   | 37   | 33   | 34   |
| 106         | 37      | 20 | 92.8  | 28                     | 32    | 38   | 43   | 43   | 48   | 45   | 43   |
| 107         | 60      | 35 | 92.8  | 29                     | 33    | 34   | 41   | 48   | 81   | 58   | 73   |
| 108         | 56      | 35 | 92.8  | 34                     | 37    | 43   | 51   | 53   | 72   | 58   | 68   |
| 109         | 32      | 14 | 92.8  | 22                     | 24    | 26   | 28   | 30   | 33   | 30   | 32   |
| 110         | 47      | 24 | 92.8  | 22                     | 30    | 36   | 45   | 59   | 73   | 56   | 70   |
| 111         | 48      | 23 | 92.8  | 31                     | 37    | 42   | 50   | 57   | 69   | 58   | 64   |

**Table E1 (Continued): Age, Years of Exposure, Noise level and Hearing Threshold of the Quarry Workers in the year 2019.**

| No          | FACTORS |    |      | HEARING THRESHOLD (dB) |       |      |      |      |      |      |      |
|-------------|---------|----|------|------------------------|-------|------|------|------|------|------|------|
|             | AG      | YE | NL   | 250Hz                  | 500Hz | 1kHz | 2kHz | 3kHz | 4kHz | 6kHz | 8kHz |
| 112         | 46      | 26 | 92.8 | 30                     | 34    | 40   | 45   | 52   | 70   | 50   | 68   |
| 113         | 38      | 16 | 92.8 | 21                     | 21    | 23   | 24   | 26   | 37   | 28   | 34   |
| 114         | 48      | 23 | 92.8 | 38                     | 40    | 47   | 53   | 67   | 72   | 50   | 62   |
| 115         | 47      | 28 | 92.8 | 32                     | 36    | 39   | 48   | 57   | 67   | 60   | 64   |
| 116         | 37      | 19 | 92.3 | 31                     | 33    | 37   | 40   | 46   | 54   | 42   | 49   |
| 117         | 59      | 34 | 92.3 | 36                     | 41    | 46   | 53   | 59   | 69   | 51   | 70   |
| <b>*118</b> |         |    |      |                        |       |      |      |      |      |      |      |
| 119         | 33      | 14 | 92.3 | 24                     | 27    | 28   | 29   | 30   | 39   | 28   | 32   |
| 120         | 30      | 08 | 92.3 | 22                     | 24    | 25   | 27   | 28   | 32   | 28   | 29   |
| 121         | 44      | 23 | 92.3 | 29                     | 36    | 41   | 48   | 58   | 61   | 43   | 58   |
| 122         | 47      | 23 | 92.3 | 32                     | 41    | 42   | 47   | 55   | 60   | 43   | 55   |
| 123         | 37      | 13 | 92.3 | 25                     | 25    | 27   | 35   | 38   | 41   | 29   | 33   |
| 124         | 35      | 12 | 92.3 | 24                     | 25    | 25   | 27   | 31   | 37   | 24   | 29   |
| 125         | 40      | 11 | 92.3 | 23                     | 25    | 27   | 33   | 33   | 39   | 27   | 37   |
| <b>*126</b> |         |    |      |                        |       |      |      |      |      |      |      |
| 127         | 50      | 21 | 92.8 | 34                     | 38    | 44   | 51   | 57   | 69   | 50   | 60   |
| <b>*128</b> |         |    |      |                        |       |      |      |      |      |      |      |
| 129         | 45      | 26 | 92.8 | 36                     | 40    | 44   | 59   | 60   | 73   | 46   | 57   |
| 130         | 50      | 21 | 92.8 | 35                     | 39    | 49   | 54   | 62   | 73   | 50   | 60   |
| 131         | 46      | 21 | 92.8 | 33                     | 39    | 41   | 51   | 57   | 63   | 44   | 48   |
| 132         | 45      | 20 | 92.8 | 34                     | 35    | 45   | 50   | 58   | 66   | 49   | 55   |
| 133         | 48      | 17 | 92.8 | 35                     | 40    | 43   | 54   | 59   | 72   | 45   | 56   |
| 134         | 38      | 18 | 92.8 | 24                     | 29    | 37   | 46   | 55   | 65   | 35   | 47   |
| 135         | 42      | 23 | 92.8 | 29                     | 35    | 42   | 49   | 59   | 67   | 40   | 51   |
| 136         | 39      | 18 | 97.0 | 24                     | 26    | 29   | 32   | 37   | 47   | 33   | 44   |
| 137         | 36      | 16 | 97.0 | 28                     | 29    | 30   | 34   | 36   | 48   | 39   | 45   |
| <b>*138</b> |         |    |      |                        |       |      |      |      |      |      |      |
| 139         | 53      | 30 | 88.0 | 33                     | 36    | 40   | 48   | 57   | 82   | 64   | 80   |
| 140         | 52      | 34 | 97.0 | 34                     | 37    | 40   | 47   | 55   | 85   | 61   | 80   |

**Table E1 (Continued): Age, Years of Exposure, Noise level and Hearing Threshold of the Quarry Workers in the yearr 2019.**

| No          | FACTORS |    |       | HEARING THRESHOLD (dB) |       |      |      |           |      |      |      |
|-------------|---------|----|-------|------------------------|-------|------|------|-----------|------|------|------|
|             | AG      | YE | NL    | 250Hz                  | 500Hz | 1kHz | 2kHz | 3kHz      | 4kHz | 6kHz | 8kHz |
| 141         | 40      | 17 | 97.0  | 30                     | 34    | 36   | 44   | 53        | 71   | 57   | 78   |
| 142         | 41      | 16 | 59.0  | 28                     | 30    | 34   | 40   | 46        | 58   | 45   | 53   |
| 143         | 49      | 25 | 60.4  | 29                     | 33    | 40   | 47   | 57        | 70   | 51   | 64   |
| 144         | 51      | 30 | 40.6  | 29                     | 33    | 39   | 48   | 53        | 76   | 40   | 73   |
| 145         | 36      | 14 | 114.5 | 24                     | 27    | 29   | 30   | 31        | 41   | 28   | 39   |
| 146         | 52      | 32 | 114.5 | 27                     | 39    | 48   | 50   | 56        | 73   | 47   | 71   |
| 147         | 50      | 21 | 114.5 | 28                     | 34    | 39   | 43   | 59        | 71   | 53   | 61   |
| <b>*148</b> |         |    |       |                        |       |      |      |           |      |      |      |
| 149         | 41      | 18 | 112.2 | 23                     | 29    | 36   | 45   | 54        | 69   | 41   | 55   |
| 150         | 53      | 28 | 112.2 | 30                     | 40    | 47   | 52   | <b>60</b> | 93   | 57   | 72   |
| 151         | 54      | 33 | 112.2 | 34                     | 42    | 49   | 52   | 64        | 85   | 61   | 69   |
| 152         | 35      | 14 | 112.2 | 22                     | 23    | 25   | 26   | 29        | 34   | 32   | 37   |
| 153         | 31      | 15 | 112.2 | 22                     | 24    | 24   | 26   | 34        | 40   | 36   | 35   |
| 154         | 40      | 19 | 101.7 | 26                     | 30    | 33   | 36   | 40        | 53   | 41   | 47   |
| 155         | 43      | 21 | 101.7 | 29                     | 37    | 45   | 49   | 49        | 78   | 40   | 54   |
| 156         | 39      | 17 | 101.7 | 25                     | 27    | 29   | 31   | 33        | 40   | 35   | 37   |
| 157         | 49      | 17 | 101.7 | 35                     | 39    | 43   | 48   | 59        | 72   | 51   | 61   |
| <b>*158</b> |         |    |       |                        |       |      |      |           |      |      |      |
| 159         | 47      | 22 | 96.5  | 33                     | 38    | 42   | 46   | 56        | 63   | 44   | 69   |
| 160         | 31      | 12 | 96.5  | 22                     | 24    | 27   | 30   | 32        | 40   | 34   | 33   |
| 161         | 52      | 32 | 96.5  | 35                     | 40    | 47   | 53   | 62        | 79   | 47   | 73   |
| 162         | 36      | 14 | 96.5  | 21                     | 23    | 25   | 27   | 30        | 40   | 34   | 35   |
| 163         | 30      | 08 | 96.5  | 20                     | 23    | 23   | 26   | 27        | 30   | 28   | 29   |
| 164         | 42      | 18 | 96.5  | 29                     | 30    | 37   | 46   | 54        | 77   | 50   | . 70 |
| 165         | 56      | 34 | 96.5  | 35                     | 48    | 53   | 54   | 68        | 99   | 68   | 84   |
| 166         | 57      | 37 | 98.1  | 39                     | 47    | 52   | 57   | 58        | 80   | 50   | 72   |
| 167         | 21      | 02 | 98.1  | 23                     | 25    | 26   | 28   | 29        | 30   | 27   | 29   |
| 168         | 44      | 23 | 98.1  | 27                     | 35    | 40   | 44   | 55        | 67   | 43   | 52   |
| 169         | 36      | 19 | 98.1  | 24                     | 24    | 25   | 26   | 28        | 35   | 27   | 30   |

**Table E1 (Continued): Age, Years of Exposure, Noise level and Hearing Threshold of the Quarry Workers in the year 2019.**

| No          | FACTORS |    |      | HEARING THRESHOLD (dB) |       |      |      |      |      |      |      |
|-------------|---------|----|------|------------------------|-------|------|------|------|------|------|------|
|             | AG      | YE | NL   | 250Hz                  | 500Hz | 1kHz | 2kHz | 3kHz | 4kHz | 6kHz | 8kHz |
| 170         | 50      | 22 | 98.1 | 21                     | 24    | 27   | 30   | 39   | 64   | 53   | 57   |
| 171         | 46      | 21 | 98.1 | 25                     | 26    | 38   | 40   | 50   | 66   | 37   | 50   |
| <b>*172</b> |         |    |      |                        |       |      |      |      |      |      |      |
| 173         | 34      | 13 | 93.3 | 22                     | 24    | 26   | 27   | 28   | 37   | 25   | 33   |
| 174         | 50      | 24 | 93.3 | 36                     | 40    | 42   | 49   | 61   | 89   | 49   | 60   |
| 175         | 61      | 38 | 93.3 | 33                     | 40    | 44   | 50   | 59   | 80   | 59   | 75   |
| 176         | 51      | 27 | 93.3 | 31                     | 39    | 41   | 48   | 63   | 69   | 48   | 67   |
| <b>*177</b> |         |    |      |                        |       |      |      |      |      |      |      |
| 178         | 39      | 20 | 90.2 | 25                     | 27    | 29   | 30   | 32   | 39   | 32   | 35   |
| 179         | 44      | 23 | 90.2 | 27                     | 32    | 40   | 48   | 59   | 70   | 50   | 62   |
| 180         | 40      | 12 | 88.2 | 23                     | 25    | 27   | 28   | 29   | 33   | 28   | 33   |
| 181         | 37      | 16 | 88.2 | 23                     | 25    | 27   | 29   | 33   | 39   | 30   | 36   |
| 182         | 47      | 20 | 88.2 | 28                     | 32    | 38   | 40   | 45   | 72   | 49   | 68   |
| 183         | 31      | 12 | 88.2 | 24                     | 27    | 28   | 30   | 31   | 33   | 28   | 31   |
| 184         | 41      | 20 | 95.4 | 29                     | 34    | 36   | 44   | 57   | 63   | 36   | 42   |

**AG = Age (years)**

**YE = Years of exposure (years)**

**NL = Noise level (dB)**

**Subject Numbers 6, 18, 21, 30, 35, 40, 50, 89, 94, 100, 118, 126, 128, 138, 148, 158, 172, 177 and 189 that partake during 2018 Experiment, were not available during 2019 experiment..**

### **DAILY EQUIVALENT NOISE LEVEL OF MACHINE AT THE QUARRIES**

**Table E2: Noise level of machine at the quarry 1 [Q1]**

|                   | 9am- 10am                | 10am- 11am | 11am-12noon | 12noon- 1pm | 1pm- 2pm | 2pm- 3pm | 3pm- 4pm | 4pm- 5pm |
|-------------------|--------------------------|------------|-------------|-------------|----------|----------|----------|----------|
| <b>Day 1</b>      | <b>Noise Level (dBA)</b> |            |             |             |          |          |          |          |
| Generator         | 96                       | 96         | 96          | 96          | 96       | 96       | 96       | 96       |
| Primary Crusher   | 115                      | 115        | 116         | 117         | 117      | 117      | 117      | 117      |
| Secondary Crusher | 118                      | 118        | 117         | 116         | 117      | 117      | 118      | 118      |
| Dumper            | 96                       | 96         | 96          | 96          | 96       | 96       | 96       | 96       |
| Compressor        | 112                      | 112        | 114         | 114         | 114      |          |          |          |
| Wagon Drilling    | 95                       | 95         | 95          | 94          | 94       |          |          |          |
| Pay loader        | 93                       | 94         | 95          | 95          | 95       | 95       | 95       | 95       |
| Drilling Machine  | 89.4                     | 89.4       | 89.5        | 89.5        | 89.6     | 89.2     | 89.4     | 89.4     |
| Lathe Machine     | 87.6                     | 87.4       | 87.5        | 87.4        | 87.5     | 87.6     | 87.4     | 87.4     |
| Excavator         | 97.1                     | 97.1       | 97.1        | 97.5        | 97.5     | 97.5     | 97.6     | 97.5     |
| Leq               | 120.5                    | 120.5      | 120.6       | 120.7       | 121.0    | 120.1    | 120.1    | 120.1    |

**Table E2 (Continued): Noise level of machine at the quarry 1 [Q1]**

|                          | 9am- 10am | 10am- 11am | 11am- 12noon | 12noon- 1pm | 1pm- 2pm | 2pm- 3pm | 3pm- 4pm | 4pm- 5pm |
|--------------------------|-----------|------------|--------------|-------------|----------|----------|----------|----------|
| <b>Day 2</b>             |           |            |              |             |          |          |          |          |
| <b>Noise Level (dBA)</b> |           |            |              |             |          |          |          |          |
| Generator                | 95        | 95         | 95           | 95          | 95       | 95       | 95       | 95       |
| Primary Crusher          | 115       | 115        | 116          | 116         | 117      | 117      | 116      | 117      |
| Secondary Crusher        | 118       | 118        | 117          | 117         | 116      | 117      | 117      | 118      |
| Dumper                   | 96        | 96         | 96           | 96          | 96       | 96       | 96       | 96       |
| Compressor               | 112       | 112        | 113          | 114         | 114      | 114      | 114      | 114      |
| Wagon Drilling           | 95        | 95         | 95           | 94          | 94       | 95       | 95       | 95       |
| Pay loader               | 92        | 93         | 93           | 93          | 94       | 95       | 95       | 95       |
| Drilling Machine         | 97.0      | 97.0       | 97.0         | 97.3        | 97.3     | 97.2     | 97.2     | 97.2     |
| Lathe Machine            | 88.1      | 88.0       | 88.1         | 88.5        | 88.5     | 88.5     | 88.6     | 88.5     |
| Excavator Machine        | 97.0      | 97.0       | 97.1         | 97.2        | 97.2     | 97.5     | 97.4     | 97.5     |
| Leq                      | 120.5     | 120.5      | 120.5        | 120.6       | 120.7    | 121.0    | 121.0    | 121.5    |
| <b>Day 3</b>             |           |            |              |             |          |          |          |          |
| Generator                | 94        | 94         | 94           | 95          | 95       | 95       | 95       | 95       |
| Primary Crusher          | 114       | 114        | 115          | 115         | 115      | 115      | 115      | 115      |
| Secondary Crusher        | 117       | 117        | 117          | 117         | 117      | 118      | 118      | 118      |
| Dumper                   | 96        | 96         | 96           | 96          | 96       | 96       | 96       | 96       |
| Compressor               | 113       | 113        | 114          | 114         | 114      | 114      | 114      | 114      |
| Wagon Drilling           | 94        | 94         | 94           | 94          | 94       | 94       | 94       | 94       |
| Pay loader               | 92        | 93         | 93           | 93          | 94       | 95       | 95       | 95       |
| Drilling Machine         | 96.9      | 96.9       | 96.9         | 97.0        | 97.0     | 97.0     | 97.1     | 97.2     |
| Lathe Machine            | 87.5      | 87.5       | 87.5         | 87.6        | 87.6     | 87.7     | 87.7     | 87.7     |
| Excavator                | 97.1      | 97.1       | 97.1         | 97.5        | 97.5     | 97.5     | 97.6     | 97.6     |
| Leq                      | 119.8     | 119.8      | 120.3        | 120.3       | 120.3    | 120.8    | 120.8    | 120.8    |

**Table E2 (Continued): Noise level of machine at the quarry 1 [Q1]**

|                   | <b>9am-<br/>10am</b>     | <b>10am-<br/>11am</b> | <b>11am-<br/>12noon</b> | <b>12noon-<br/>1pm</b> | <b>1pm-<br/>2pm</b> | <b>2pm-<br/>3pm</b> | <b>3pm-<br/>4pm</b> | <b>4pm-<br/>5pm</b> |
|-------------------|--------------------------|-----------------------|-------------------------|------------------------|---------------------|---------------------|---------------------|---------------------|
| <b>Day 4</b>      |                          |                       |                         |                        |                     |                     |                     |                     |
|                   | <b>Noise Level (dBA)</b> |                       |                         |                        |                     |                     |                     |                     |
| Generator         | 92                       | 93                    | 93                      | 93                     | 94                  | 94                  | 94                  | 94                  |
| Primary Crusher   | 114                      | 114                   | 113                     | 114                    | 115                 | 115                 | 115                 | 115                 |
| Secondary Crusher | 116                      | 116                   | 117                     | 116                    | 117                 | 117                 | 117                 | 117                 |
| Dumper            | 94                       | 95                    | 95                      | 95                     | 94                  | 95                  | 95                  | 95                  |
| Compressor        | 113                      | 113                   | 114                     | 114                    | 114                 | 114                 |                     |                     |
| Wagon Drilling    | 95                       | 95                    | 95                      | 95                     | 95                  | 95                  |                     |                     |
| Pay loader        | 91                       | 91                    | 91                      | 92                     | 93                  | 93                  | 94                  | 94                  |
| Drilling Machine  | 97.0                     | 97.0                  | 97.0                    | 97.0                   | 97.0                | 97.0                | 97.0                | 97.0                |
| Lathe Machine     | 87.5                     | 87.6                  | 87.6                    | 87.7                   | 87.7                | 87.7                | 87.7                | 87.7                |
| Excavator         | 97.2                     | 97.3                  | 97.3                    | 97.3                   | 97.5                | 97.5                | 97.5                | 97.5                |
| Leq               | 119.3                    | 119.3                 | 119.8                   | 119.6                  | 120.3               | 120.3               | 119.2               | 119.2               |
| <b>Day 5</b>      |                          |                       |                         |                        |                     |                     |                     |                     |
| Generator         | 90                       | 91                    | 92                      | 93                     | 93                  | 93                  | 93                  | 93                  |
| Primary Crusher   | 113                      | 111                   | 112                     | 113                    | 114                 | 114                 | 114                 | 114                 |
| Secondary Crusher | 115                      | 115                   | 115                     | 116                    | 116                 | 117                 | 117                 | 117                 |
| Dumper            | 95                       | 95                    | 95                      | 95                     | 95                  | 95                  | 95                  | 95                  |
| Compressor        | 114                      | 113                   | 114                     | 113                    |                     |                     | 114                 | 114                 |
| Wagon Drilling    | 94                       | 93                    | 94                      | 94                     |                     |                     | 94                  | 94                  |
| Pay loader        | 90                       | 90                    | 89                      | 91                     | 91                  | 91                  |                     | 93                  |
| Drilling Machine  | 97.0                     | 97.0                  | 97.0                    | 97.1                   | 97.2                | 97.2                | 97.2                | 97.2                |
| Lathe Machine     | 87.1                     | 87.1                  | 87.2                    | 87.2                   | 87.3                | 87.3                | 87.3                | 87.3                |
| Excavator         | 97.2                     | 97.2                  | 97.3                    | 97.3                   | 97.3                | 97.3                | 97.3                | 97.3                |
| Leq               | 118.9                    | 118.1                 | 118.7                   | 119.1                  | 118.2               | 118.2               | 118.2               | 120.1               |



**Table E3: Noise level of machine at the quarry 2 [Q2]**

|                      | 9am-<br>10am             | 10am-<br>11am | 11am-<br>12noon | 12noon-<br>1pm | 1pm-<br>2pm | 2pm-<br>3pm | 3pm-<br>4pm | 4pm-<br>5pm |
|----------------------|--------------------------|---------------|-----------------|----------------|-------------|-------------|-------------|-------------|
| <b>Day 1</b>         | <b>Noise Level (dBA)</b> |               |                 |                |             |             |             |             |
| Generator            | 95                       | 95            | 96              | 96             | 99          | 98          | 99          | 93          |
| Primary Crusher      | 108                      | 108           | 111             | 111            | 112         | 113         | 113         | 113         |
| Secondary<br>Crusher | 105                      | 105           | 106             | 107            | 107         | 108         | 108         | 108         |
| Dumper               | 94                       | 94            | 94              | 95             | 95          | 96          | 95          | 96          |
| Compressor           | 108                      | 109           | 108             |                | 108         |             | 109         | 108         |
| Wagon Drilling       | 90                       | 90            | 93              |                | 92          |             | 93          | 93          |
| Pay loader           | 89                       | 89            | 91              | 93             | 93          | 93          | 93          | 93          |
| Drilling Machine     | 97.1                     | 97.1          | 97.1            | 97.3           | 97.3        | 97.3        | 97.3        | 97.3        |
| Lathe Machine        | 86.5                     | 86.5          | 87.1            | 87.4           | 87.4        | 87.5        | 87.5        | 87.5        |
| Excavator            | 96.5                     | 96.5          | 97.1            | 97.2           | 97.2        | 97.2        | 97.2        | 97.2        |
| Leq                  | 112.2                    | 112.2         | 113.8           | 112.7          | 114.6       | 114.4       | 115.5       | 115.3       |

**Day 2**

|                   |       |       |       |       |       |       |      |       |
|-------------------|-------|-------|-------|-------|-------|-------|------|-------|
| Generator         | 96    | 96    | 97    | 97    | 97    | 98    | 99   | 99    |
| Primary Crusher   | 108   | 107   | 109   | 109   | 111   | 110   | 112  | 112   |
| Secondary Crusher | 106   | 106   | 107   | 108   | 108   | 109   | 109  | 109   |
| Dumper            | 94    | 94    | 94    | 95    | 95    | 95    | 95   | 95    |
| Compressor        | 108   | 108   | 108   | 108   | 108   | 108   | 109  | 109   |
| Wagon Drilling    | 90    | 89    | 91    | 92    | 92    | 93    | 93   | 94    |
| Pay loader        | 89    | 89    | 91    | 93    | 92    | 93    | 93   | 93    |
| Drilling Machine  | 96.0  | 96.2  | 96.5  | 97.0  | 97.0  | 97.0  |      | 97.0  |
| Lathe Machine     | 87.4  | 87.4  | 87.5  | 87.5  | 87.5  | 87.5  | 97.0 | 87.5  |
| Excavator Machine | 96.8  | 96.7  | 96.8  | 97.1  | 97.1  | 97.1  | 87.5 | 97.1  |
| Leq               | 112.4 | 112.2 | 113.8 | 112.7 | 114.6 | 114.4 | 97.1 | 115.3 |

|                          | <b>9am-<br/>10am</b> | <b>10am-<br/>11am</b> | <b>11am-<br/>12noon</b> | <b>12noon-<br/>1pm</b> | <b>1pm-<br/>2pm</b> | <b>2pm-<br/>3pm</b> | <b>3pm-<br/>4pm</b> | <b>4pm-<br/>5pm</b> |
|--------------------------|----------------------|-----------------------|-------------------------|------------------------|---------------------|---------------------|---------------------|---------------------|
| <b>Noise Level (dBA)</b> |                      |                       |                         |                        |                     |                     |                     |                     |
| <b>Day 3</b>             |                      |                       |                         |                        |                     |                     |                     |                     |
| Generator                | 98                   | 98                    | 98                      | 97                     | 97                  | 97                  | 98                  | 98                  |
| Primary Crusher          | 112                  | 112                   | 112                     | 112                    | 113                 | 113                 | 113                 | 113                 |
| Secondary Crusher        | 107                  | 108                   | 108                     | 109                    | 110                 | 110                 | 111                 | 111                 |
| Dumper                   | 94                   | 94                    | 93                      | 94                     | 93                  | 95                  | 96                  | 95                  |
| Compressor               | 108                  | 108                   |                         | 108                    | 109                 |                     | 108                 | 109                 |
| Wagon Drilling           | 90                   | 91                    |                         | 90                     | 91                  |                     | 92                  | 93                  |
| Pay loader               | 90                   | 90                    | 90                      | 93                     | 93                  | 92                  | 93                  | 92                  |
| Drilling Machine         | 97.0                 | 97.2                  | 97.2                    | 97.2                   | 97.2                | 97.2                | 97.2                | 97.2                |
| Lathe Machine            | 87.0                 | 87.2                  | 87.2                    | 87.2                   | 87.2                | 87.2                | 87.2                | 87.2                |
| Excavator Machine        | 95.9                 | 95.9                  | 95.9                    | 95.9                   | 95.9                | 96.0                | 96.0                | 96.0                |
| Leq                      | 114.5                | 114.7                 | 113.6                   | 114.9                  | 115.9               | 114.9               | 116.0               | 116.2               |

**Table E3 (Continued): Noise level of machine at the quarry 2 [Q2]**

| <b>Day 4</b>      |       |       |       |       |       |       |       |       |
|-------------------|-------|-------|-------|-------|-------|-------|-------|-------|
| Generator         | 98    | 97    | 97    | 97    | 97    | 98    | 99    | 99    |
| Primary Crusher   | 113   | 113   | 114   | 115   | 115   | 115   | 115   | 115   |
| Secondary Crusher | 109   | 108   | 108   | 110   | 109   | 110   | 110   | 110   |
| Dumper            | 93    | 93    | 93    | 94    | 95    | 95    | 95    | 95    |
| Compressor        | 107   | 108   | 108   | 108   | 109   | 109   |       |       |
| Wagon Drilling    | 90    | 90    | 89    | 90    | 91    | 92    |       |       |
| Pay loader        | 91    | 90    | 90    | 90    | 92    | 93    | 93    | 92    |
| Drilling Machine  | 89.4  | 89.4  | 89.5  | 90.0  | 90.0  | 90.0  | 90.0  | 90.0  |
| Lathe Machine     | 87.0  | 87.5  | 87.5  | 87.5  | 87.5  | 87.5  | 87.5  | 87.5  |
| Excavator Machine | 97.0  | 97.1  | 97.1  | 97.1  | 97.1  | 97.1  | 97.1  | 97.1  |
| Leq               | 115.3 | 115.2 | 115.9 | 116.9 | 116.9 | 117.1 | 116.3 | 116.3 |

**Table E3 (Continued): Noise level of machine at the quarry 2 [Q2]**

|                          | <b>9am-<br/>10am</b> | <b>10am-<br/>11am</b> | <b>11am-<br/>12noon</b> | <b>12noon-<br/>1pm</b> | <b>1pm-<br/>2pm</b> | <b>2pm-<br/>3pm</b> | <b>3pm-<br/>4pm</b> | <b>4pm-<br/>5pm</b> |
|--------------------------|----------------------|-----------------------|-------------------------|------------------------|---------------------|---------------------|---------------------|---------------------|
| <b>Noise Level (dBA)</b> |                      |                       |                         |                        |                     |                     |                     |                     |
| <b>Day 5</b>             |                      |                       |                         |                        |                     |                     |                     |                     |
| Generator                | 97                   | 96                    | 97                      | 97                     | 96                  | 97                  | 97                  | 96                  |
| Primary Crusher          | 112                  | 113                   | 113                     | 114                    | 114                 | 115                 | 115                 | 114                 |
| Secondary Crusher        | 109                  | 108                   | 108                     | 110                    | 111                 | 112                 | 113                 | 113                 |
| Dumper                   | 94                   | 94                    | 95                      | 94                     | 94                  | 95                  | 95                  | 95                  |
| Compressor               | 108                  | 108                   | 108                     | 109                    | 109                 | 109                 | 109                 | 109                 |
| Wagon Drilling           | 90                   | 91                    | 89                      | 91                     | 90                  | 91                  | 91                  | 91                  |
| Pay loader               | 89                   | 88                    | 90                      | 92                     | 92                  | 92                  | 92                  | 92                  |
| Drilling Machine         | 96.8                 | 97.1                  | 97.0                    | 97.0                   | 97.1                | 97.1                | 97.0                | 97.0                |
| Lathe Machine            | 87.0                 | 87.1                  | 87.0                    | 87.0                   | 87.0                | 87.0                | 87.0                | 87.0                |
| Excavator Machine        | 94.5                 | 94.5                  | 94.5                    | 95.0                   | 95.0                | 95.2                | 95.4                | 95.6                |
| Leq                      | 114.9                | 115.2                 | 115.3                   | 116.4                  | 116.7               | 117.5               | 117.8               | 117.3               |

**Table E4: Noise level of machine at the quarry 3 [Q3]**

|                          | <b>9am-<br/>10am</b> | <b>10am-<br/>11am</b> | <b>11am-<br/>12noon</b> | <b>12noon-<br/>1pm</b> | <b>1pm-<br/>2pm</b> | <b>2pm-<br/>3pm</b> | <b>3pm-<br/>4pm</b> | <b>4pm-<br/>5pm</b> |       |
|--------------------------|----------------------|-----------------------|-------------------------|------------------------|---------------------|---------------------|---------------------|---------------------|-------|
| <b>Noise Level (dBA)</b> |                      |                       |                         |                        |                     |                     |                     |                     |       |
| <b>Day 1</b>             |                      |                       |                         |                        |                     |                     |                     |                     |       |
| Generator                |                      | 91                    | 91                      | 92                     | 93                  | 93                  | 92                  | 93                  | 93    |
| Primary Crusher          |                      | 112                   | 112                     | 111                    | 112                 | 112                 | 114                 | 114                 | 114   |
| Secondary Crusher        |                      | 114                   | 115                     | 114                    | 115                 | 114                 | 115                 | 115                 | 115   |
| Dumper                   |                      | 93                    | 93                      | 93                     | 95                  | 95                  | 95                  | 94                  | 95    |
| Compressor               |                      | 112                   | 113                     | 112                    | 113                 | 112                 | 113                 | 113                 | 113   |
| Wagon Drilling           |                      | 93                    | 93                      | 92                     | 93                  | 93                  | 93                  | 93                  | 93    |
| Pay loader               |                      | 89                    | 91                      | 91                     | 92                  | 92                  | 92                  | 92                  | 93    |
| Drilling Machine         |                      | 97.8                  | 97.8                    | 97.8                   | 98.0                | 98.0                | 98.0                | 98.0                | 98.0  |
| Lathe Machine            |                      | 89.0                  | 89.0                    | 89.0                   | 89.0                | 89.0                | 89.0                | 89.0                | 89.0  |
| Excavator Machine        |                      | 98.0                  | 98.0                    | 98.0                   | 98.0                | 98.0                | 98.0                | 98.0                | 98.0  |
| Leq                      |                      | 117.6                 | 118.3                   | 117.3                  | 118.3               | 117.6               | 118.9               | 118.9               | 118.9 |
| <b>Day 2</b>             |                      |                       |                         |                        |                     |                     |                     |                     |       |
| Generator                | 90                   | 91                    | 91                      | 92                     | 93                  | 92                  | 93                  | 93                  |       |
| Primary Crusher          | 111                  | 111                   | 111                     | 111                    | 113                 | 113                 | 114                 | 114                 |       |
| Secondary Crusher        | 115                  | 115                   | 115                     | 115                    | 115                 | 115                 | 115                 | 115                 |       |
| Dumper                   | 92                   | 92                    | 93                      | 94                     | 95                  | 95                  | 95                  | 95                  |       |
| Compressor               | 112                  | 112                   | 112                     | 113                    | 113                 | 113                 | 114                 | 113                 |       |
| Wagon Drilling           | 92                   | 92                    | 92                      | 92                     | 93                  | 93                  | 93                  | 93                  |       |
| Pay loader               | 90                   | 92                    | 93                      | 93                     | 93                  | 93                  | 93                  | 93                  |       |
| Drilling Machine         | 97.0                 | 97.0                  | 97.0                    | 97.0                   | 97.0                | 97.0                | 97.0                | 97.0                |       |
| Lathe Machine            | 88.0                 | 88.0                  | 88.0                    | 88.0                   | 88.0                | 88.0                | 88.0                | 88.0                |       |
| Excavator Machine        | 97.3                 | 97.3                  | 97.3                    | 97.5                   | 97.5                | 97.5                | 97.5                | 97.5                |       |
| Leq                      | 117.8                | 117.8                 | 117.8                   | 118.1                  | 118.6               | 118.6               | 119.2               | 119.2               |       |

**Table E4: Noise level of machine at the quarry 3 [Q3]**

|                   | <b>9am-<br/>10am</b>     | <b>10am-<br/>11am</b> | <b>11am-<br/>12noon</b> | <b>12noon-<br/>1pm</b> | <b>1pm-<br/>2pm</b> | <b>2pm-<br/>3pm</b> | <b>3pm-<br/>4pm</b> | <b>4pm-<br/>5pm</b> |
|-------------------|--------------------------|-----------------------|-------------------------|------------------------|---------------------|---------------------|---------------------|---------------------|
| <b>Day 3</b>      | <b>Noise Level (dBA)</b> |                       |                         |                        |                     |                     |                     |                     |
| Generator         | 92                       | 93                    | 93                      | 95                     | 95                  | 95                  | 96                  | 96                  |
| Primary Crusher   | 114                      | 114                   | 115                     | 115                    | 115                 | 115                 | 115                 | 115                 |
| Secondary Crusher | 116                      | 116                   | 116                     | 114                    | 114                 | 115                 | 115                 | 115                 |
| Dumper            | 93                       | 93                    | 93                      | 95                     | 95                  | 95                  | 95                  | 95                  |
| Compressor        | 113                      | 113                   | 113                     | 114                    | 114                 | 114                 | 114                 | 114                 |
| Wagon Drilling    | 92                       | 92                    | 92                      | 92                     | 92                  | 93                  | 93                  | 93                  |
| Pay loader        | 90                       | 93                    | 94                      | 94                     | 95                  | 95                  | 95                  | 95                  |
| Drilling Machine  | 97.0                     | 97.0                  | 97.0                    | 97.0                   | 97.0                | 97.0                | 97.0                | 97.0                |
| Lathe Machine     | 88.0                     | 88.0                  | 88.2                    | 88.2                   | 88.5                | 88.5                | 88.5                | 88.5                |
| Excavator Machine | 97.1                     | 97.1                  | 97.1                    | 97.1                   | 97.1                | 97.1                | 97.1                | 97.1                |
| Leq               | 119.3                    | 119.3                 | 119.6                   | 119.2                  | 119.2               | 119.5               | 119.5               | 119.5               |

**Day 4**

|                   |       |       |       |       |       |       |       |       |
|-------------------|-------|-------|-------|-------|-------|-------|-------|-------|
| Generator         | 92    | 92    | 92    | 94    | 95    | 95    | 96    | 96    |
| Primary Crusher   | 114   | 114   | 115   | 116   | 116   | 116   | 116   | 116   |
| Secondary Crusher | 115   | 115   | 115   | 115   | 115   | 115   | 115   | 115   |
| Dumper            | 92    | 92    | 93    | 93    | 94    | 93    | 93    | 93    |
| Compressor        | 112   | 112   | 112   | 113   | 114   | 113   | 113   | 114   |
| Wagon Drilling    | 90    | 92    | 93    | 92    | 93    | 93    | 93    | 93    |
| Pay loader        | 90    | 90    | 90    | 94    | 95    | 95    | 95    | 95    |
| Drilling Machine  | 97.0  | 97.1  | 97.1  | 97.1  | 97.1  | 97.1  | 97.1  | 97.1  |
| Lathe Machine     | 87.5  | 87.5  | 87.5  | 87.5  | 87.5  | 87.5  | 87.5  | 87.5  |
| Excavator Machine | 97.0  | 97.0  | 97.0  | 97.0  | 97.0  | 97.0  | 97.0  | 97.0  |
| Leq               | 118.6 | 118.6 | 119.0 | 119.6 | 119.9 | 119.7 | 119.7 | 119.7 |

|  | <b>9am-<br/>10am</b>     | <b>10am-<br/>11am</b> | <b>11am-<br/>12noon</b> | <b>12noon-<br/>1pm</b> | <b>1pm-<br/>2pm</b> | <b>2pm-<br/>3pm</b> | <b>3pm-<br/>4pm</b> | <b>4pm-<br/>5pm</b> |
|--|--------------------------|-----------------------|-------------------------|------------------------|---------------------|---------------------|---------------------|---------------------|
| <b>Day 5</b>   | <b>Noise Level (dBA)</b> |                       |                         |                        |                     |                     |                     |                     |
| <b>Table E4: Noise level of machine at the quarry 3 [Q3]</b> |                          |                       |                         |                        |                     |                     |                     |                     |
| Generator  | 90                       | 93                    | 95                      | 95                     | 96                  | 96                  | 97                  | 98                  |
| Primary Crusher  | 116                      | 116                   | 116                     | 117                    | 117                 | 117                 | 117                 | 117                 |
| Secondary Crusher  | 115                      | 114                   | 115                     | 115                    | 115                 | 115                 | 115                 | 115                 |
| Dumper   | 94                       | 94                    | 94                      | 94                     | 95                  | 95                  | 95                  | 94                  |
| Compressor   | 110                      | 112                   | 113                     | 112                    | 114                 | 114                 | 115                 | 115                 |
| Wagon Drilling   | 90                       | 92                    | 93                      | 92                     | 90                  | 91                  | 92                  | 91                  |
| Pay loader   | 90                       | 90                    | 94                      | 94                     | 94                  | 94                  | 95                  | 95                  |
| Drilling Machine   | 97.0                     | 97.0                  | 97.0                    | 97.0                   | 97.1                | 97.1                | 97.1                | 97.1                |
| Lathe Machine  | 87.5                     | 87.5                  | 87.5                    | 87.5                   | 87.5                | 87.5                | 87.5                | 87.5                |
| Excavator Machine  | 97.0                     | 97.0                  | 97.0                    | 97.0                   | 97.0                | 97.0                | 97.0                | 97.0                |
| Leq  | 119.1                    | 119.1                 | 119.7                   | 119.9                  | 120.3               | 120.3               | 120.6               | 120.6               |

**Table E5: Noise level of machine at the quarry 4 [Q4]**

|                          | <b>9am-<br/>10am</b> | <b>10am-<br/>11am</b> | <b>11am-<br/>12noon</b> | <b>12noon-<br/>1pm</b> | <b>1pm-<br/>2pm</b> | <b>2pm-<br/>3pm</b> | <b>3pm-<br/>4pm</b> | <b>4pm-<br/>5pm</b> |
|--------------------------|----------------------|-----------------------|-------------------------|------------------------|---------------------|---------------------|---------------------|---------------------|
| <b>Noise Level (dBA)</b> |                      |                       |                         |                        |                     |                     |                     |                     |
| <b>Day 1</b>             |                      |                       |                         |                        |                     |                     |                     |                     |
| Generator                | 97                   | 99                    | 100                     | 102                    | 101                 | 102                 | 103                 | 103                 |
| Primary Crusher          | 113                  | 114                   | 114                     | 115                    | 115                 | 115                 | 116                 | 115                 |
| Secondary Crusher        | 110                  | 112                   | 112                     | 113                    | 114                 | 113                 | 112                 | 113                 |
| Dumper                   | 97                   | 97                    | 97                      | 97                     | 97                  | 97                  | 97                  | 97                  |
| Compressor               | 100                  | 100                   | 102                     | 102                    | 103                 | 103                 | 102                 | 102                 |
| Wagon Drilling           | 88                   | 89                    | 99                      | 98                     | 99                  | 100                 | 100                 | 101                 |
| Pay loader               | 90                   | 92                    | 92                      | 93                     | 94                  | 94                  | 96                  | 99                  |
| Drilling Machine         | 90.1                 | 90.2                  | 90.2                    | 90.2                   | 90.2                | 90.2                | 90.2                | 90.2                |
| Lathe Machine            | 87.4                 | 87.4                  | 87.4                    | 87.4                   | 87.4                | 87.4                | 87.4                | 87.4                |
| Excavator Machine        | 95.0                 | 95.2                  | 95.2                    | 95.2                   | 95.2                | 95.2                | 95.2                | 95.2                |
| Leq                      | 115.1                | 116.4                 | 116.5                   | 117.5                  | 117.9               | 117.6               | 117.9               | 117.6               |

**Table E5 (Continued): Noise level of machine at the quarry 4 [Q4]**

|                   | <b>9am-<br/>10am</b>     | <b>10am-<br/>11am</b> | <b>11am-<br/>12noon</b> | <b>12noon-<br/>1pm</b> | <b>1pm-<br/>2pm</b> | <b>2pm-<br/>3pm</b> | <b>3pm-<br/>4pm</b> | <b>4pm-<br/>5pm</b> |
|-------------------|--------------------------|-----------------------|-------------------------|------------------------|---------------------|---------------------|---------------------|---------------------|
|                   | <b>Noise Level (dBA)</b> |                       |                         |                        |                     |                     |                     |                     |
| <b>Day 2</b>      |                          |                       |                         |                        |                     |                     |                     |                     |
| Generator         | 98                       | 100                   | 100                     | 101                    | 103                 | 103                 | 102                 | 103                 |
| Primary Crusher   | 114                      | 115                   | 114                     | 116                    | 115                 | 116                 | 114                 | 115                 |
| Secondary Crusher | 110                      | 112                   | 112                     | 113                    | 112                 | 113                 | 112                 | 113                 |
| Dumper            | 96                       | 96                    | 97                      | 97                     | 96                  | 96                  | 97                  | 97                  |
| Compressor        | 99                       | 100                   | 102                     | 102                    | 103                 | 102                 | 102                 | 102                 |
| Wagon Drilling    | 87                       | 99                    | 98                      | 99                     | 100                 | 99                  | 100                 | 99                  |
| Pay loader        | 89                       | 90                    | 94                      | 96                     | 98                  | 94                  | 96                  | 99                  |
| Drilling Machine  | 90.2                     | 90.2                  | 90.2                    | 90.2                   | 90.2                | 90.2                | 90.2                | 90.2                |
| Lathe Machine     | 87.5                     | 87.5                  | 87.5                    | 87.5                   | 87.5                | 87.6                | 87.6                | 87.6                |
| Excavator Machine | 95.0                     | 95.2                  | 95.2                    | 95.2                   | 95.2                | 95.2                | 95.2                | 95.2                |
| Leq               | 115.7                    | 117.7                 | 116.5                   | 118.1                  | 117.3               | 118.1               | 116.6               | 117.6               |



**Day 3**

---

|                   |       |       |       |       |       |       |       |       |
|-------------------|-------|-------|-------|-------|-------|-------|-------|-------|
| Generator         | 98    | 100   | 100   | 101   | 102   | 102   | 102   | 101   |
| Primary Crusher   | 113   | 113   | 113   | 114   | 115   | 116   | 113   | 113   |
| Secondary Crusher | 111   | 111   | 111   | 111   | 112   | 113   | 114   | 114   |
| Dumper            | 95    | 96    | 96    | 96    | 96    | 96    | 96    | 97    |
| Compressor        | 101   | 101   | 101   | 101   | 102   | 102   | 101   | 102   |
| Wagon Drilling    | 88    | 98    | 98    | 99    | 100   | 102   | 102   | 102   |
| Pay loader        | 90    | 92    | 92    | 92    | 93    | 93    | 94    | 94    |
| Drilling Machine  | 90.2  | 90.2  | 90.2  | 90.2  | 90.2  | 90.2  | 90.2  | 90.2  |
| Lathe Machine     | 87.5  | 87.5  | 87.5  | 87.5  | 87.5  | 87.5  | 87.5  | 87.5  |
| Excavator Machine | 95.0  | 95.0  | 95.0  | 95.0  | 95.0  | 95.0  | 95.0  | 95.0  |
| Leq               | 115.4 | 115.6 | 115.6 | 116.2 | 117.2 | 118.1 | 117.0 | 117.0 |

---

**Day 4**

---

|                   |       |       |       |       |       |       |       |       |
|-------------------|-------|-------|-------|-------|-------|-------|-------|-------|
| Generator         | 98    | 100   | 101   | 102   | 104   | 104   | 103   | 102   |
| Primary Crusher   | 112   | 112   | 114   | 115   | 115   | 114   | 115   | 114   |
| Secondary Crusher | 110   | 110   | 112   | 113   | 114   | 115   | 112   | 113   |
| Dumper            | 96    | 96    | 96    | 96    | 97    | 96    | 97    | 96    |
| Compressor        | 100   | 99    | 101   | 101   | 103   | 103   | 103   | 103   |
| Wagon Drilling    | 87    | 98    | 98    | 98    | 100   | 102   | 101   | 102   |
| Pay loader        | 90    | 91    | 89    | 94    | 90    | 88    | 94    | 94    |
| Drilling Machine  | 89.2  | 89.2  | 90.1  | 90.2  | 90.2  | 90.2  | 90.2  | 90.2  |
| Lathe Machine     | 88.0  | 88.0  | 88.1  | 88.1  | 88.1  | 88.1  | 88.1  | 88.2  |
| Excavator         | 95.0  | 95.0  | 95.0  | 95.0  | 95.0  | 95.0  | 95.0  | 95.0  |
| Machine           | 114.5 | 114.6 | 116.5 | 117.5 | 118.0 | 118.0 | 117.3 | 117.1 |

---

**Table E5: Noise level of machine at the quarry 4 [Q4]****Day 5**

|                   |       |       |       |       |       |       |       |       |
|-------------------|-------|-------|-------|-------|-------|-------|-------|-------|
| Generator         | 99    | 100   | 101   | 101   | 104   | 104   | 103   | 103   |
| Primary Crusher   | 114   | 115   | 116   | 115   | 116   | 116   | 114   | 115   |
| Secondary Crusher | 111   | 111   | 112   | 112   | 113   | 113   | 112   | 112   |
| Dumper            | 97    | 97    | 97    | 97    | 97    | 96    | 96    | 96    |
| Compressor        | 99    | 100   | 102   | 103   | 103   | 103   | 103   | 103   |
| Wagon Drilling    | 88    | 99    | 99    | 100   | 102   | 101   | 104   | 99    |
| Pay loader        | 89    | 91    | 94    | 96    | 97    | 94    | 96    | 99    |
| Drilling Machine  | 89    | 89    | 89    | 90    | 90    | 90    | 90    | 90    |
| Lathe Machine     | 88.5  | 88.5  | 88.5  | 88.5  | 88.5  | 88.5  | 86.0  | 86.0  |
| Excavator Machine | 97.1  | 97.1  | 97.1  | 97.1  | 97.5  | 97.5  | 97.5  | 97.5  |
| Leq               | 116.0 | 116.8 | 117.8 | 117.2 | 118.3 | 118.2 | 116.8 | 117.3 |

## SUMMARY OF THE AVERAGE NOISE LEVEL IN THE QUARRIES

**Table E6: Summary of the Average Noise Level in Q1**

| Days                    | L <sub>eq</sub> (dB) |
|-------------------------|----------------------|
| 1                       | 120.3                |
| 2                       | 120.8                |
| 3                       | 120.4                |
| 4                       | 119.6                |
| 5                       | 118.9                |
| Average L <sub>eq</sub> | 120.0                |

**Table E7: Summary of the Average Noise Level in Q2**

| Days                    | L <sub>eq</sub> (dB) |
|-------------------------|----------------------|
| 1                       | 113.8                |
| 2                       | 113.7                |
| 3                       | 115.1                |
| 4                       | 116.2                |
| 5                       | 116.4                |
| Average L <sub>eq</sub> | 115.0                |

**Table E8: Summary of the Average Noise Level in Q3**

| Days                    | L <sub>eq</sub> (dB) |
|-------------------------|----------------------|
| 1                       | 118.2                |
| 2                       | 118.4                |
| 3                       | 119.4                |
| 4                       | 119.4                |
| 5                       | 120.0                |
| Average L <sub>eq</sub> | 119.1                |

**Table E9: Summary of the Average Noise Level in Q4**

| <b>Days</b>             | <b>L<sub>eq</sub> (dB)</b> |
|-------------------------|----------------------------|
| 1                       | 117.1                      |
| 2                       | 117.2                      |
| 3                       | 116.5                      |
| 4                       | 116.7                      |
| 5                       | 117.3                      |
| Average L <sub>eq</sub> | 117.0                      |

**Table E11: Respondent in production section and non production section between the year 2018 and 2019.**

| <b>Quarry</b> | <b>2018</b>               |                               | <b>2019</b>               |                               |
|---------------|---------------------------|-------------------------------|---------------------------|-------------------------------|
|               | <b>Production section</b> | <b>Non-production section</b> | <b>Production section</b> | <b>Non-production section</b> |
| <b>1</b>      | 45                        | 07                            | 45                        | 05                            |
| <b>2</b>      | 49                        | 10                            | 49                        | 09                            |
| <b>3</b>      | 61                        | 11                            | 42                        | 10                            |
| <b>4</b>      | 49                        | 07                            | 49                        | 6                             |
| <b>TOTAL</b>  | 204                       | 35                            | 185                       | 30                            |

## APPENDIX F

### POPULATION SAMPLE

Generally the larger the population, the larger the sampling ratio needed for representativeness. For populations under 1000, a minimum ratio of 30% (300 individuals) is advisable to ensure representativeness of the sample. For larger populations, such as a population of 10000, a comparatively small minimum ratio of 10% (1000) is required for representativeness.

| <b>Quarry</b> | <b>No of quarry workers</b> | <b>2018 Sample</b> | <b>2019 Sample</b> |
|---------------|-----------------------------|--------------------|--------------------|
| Q1            | 62                          | 45 (72.58%)        | 41(66.13%)         |
| Q2            | 67                          | 49 (73.13%)        | 46(68.66%)         |
| Q3            | 79                          | 61 (77.22%)        | 58(73.42%)         |
| Q4            | 65                          | 49 (77.78%)        | 40(77.78%)         |
| Total         | 271                         | 204 (75.27%)       | 185(68.27%)        |

Of a total of 271 of quarry workers in the four sites 204 were sampled, representing 75.27% of the population of the quarry workers in the year 2018 and 185 out of the same 204 in the year 2018, were sampled in the year 2019, which is sufficient, (Suskie, 1996; Nardi, 2003; Neuman, 2007) recommended 30% for a population below 10000. Each site was represented a cluster of quarry workers which exhibited the characteristics of input variables. Within each cluster, a simple probabilistic sampling technique of casting lots was used to select the quarry workers used for the study.

## APPENDIX G

### Results of F Test of Variance Equality of Hearing Threshold of Baseline Year and a Subsequent Year at Different Frequencies

| Frequency | F value | p-value | Hearing Threshold Variance 1 (Year 2018) | Hearing Threshold Variance 2 (Year 2019) | Variance Ratio | Confidence Interval |           |
|-----------|---------|---------|--|--|----------------|---------------------|-----------|
| 250Hz     | 0.78235 | 0.08791 | 14.56627                                 | 18.61857                                 | 0.782352       | 0.5889462           | 1.0372038 |
| 500Hz     | 0.77075 | 0.07027 | 24.28018                                 | 31.50188                                 | 0.7707535      | 0.580215            | 1.021827  |
| 1kHz      | 0.97523 | 0.86    | 41.51171                                 | 42.56598                                 | 0.9752321      | 0.734144            | 1.2929148 |
| 2kHz      | 1.1535  | 0.3237  | 65.98964                                 | 57.20787                                 | 1.153506       | 0.8683471           | 1.5292619 |
| 3kHz      | 1.1377  | 0.3728  | 95.86349                                 | 84.26381                                 | 1.137659       | 0.8564176           | 1.5082526 |
| 4kHz      | 1.234   | 0.1463  | 233.5254                                 | 189.2402                                 | 1.234016       | 0.928954            | 1.635998  |
| 6kHz      | 0.89301 | 0.4307  | 141.7866                                 | 158.7743                                 | 0.8930076      | 0.6722465           | 1.1839056 |
| 8kHz      | 0.94078 | 0.6701  | 134.6766                                 | 143.1541                                 | 0.940781       | 0.7082098           | 1.2472412 |

F test of variance equality is an inferential statistical indicator to show whether there is significant difference in variances between two datasets. The test is a means of showing whether two datasets come from the same population even though a measurement from the population differs in time, such as in years, because it is expected that a measurement (a measurement of a variable) on a normal distribution should have approximately the same variance irrespective of the time the measurement is taken as long the experiment conditions are still valid. In the case of hearing threshold measurements for the base year (the first year) and second year, there are significant differences in hearing threshold values at experimental frequencies; because the measurements came from the hearing threshold of the same population of quarry workers, their variances should be approximately equal. F value is the variance ratio value.

The F values of variance equality at frequency 250 Hz, 500 Hz, 1 kHz, 2 kHz, 3 kHz, 4 kHz, 6 kHz and 8 kHz are not significant at the respective p-values as each of them is greater than alpha values of 0.05, thus suggest the acceptance of null hypothesis that the true variance ratio of hearing threshold at each frequency is equal to 1. The variance ratio is only equal to 1, when both variances of hearing threshold values of workers for two datasets are roughly equal. Each variance ratio is approximately 1. Conclusively, the datasets on hearing threshold came from the same population of quarry workers.

The confidence interval of 95% is a statistic that shows confidence in the estimate obtained. 95% confidence interval is the probability that out of 100 samples drawn from the population of quarry workers, there is confidence that 95% of those samples will contain the population's true variance ratio within the stated interval. Apparently, the variance ratio interval for each of hearing threshold is compact, as the upper and lower limits are closer to 1 than not.



**APPENDIX H**  
**Experimental Design**

**Table H: Experimental Design and its Response for the Hearing Threshold of the Quarry Workers.**

| Std | FACTORS |    |             | RESPONSES     |                        |                       |                       |                       |                       |                       |                       |
|-----|---------|----|-------------|---------------|------------------------|-----------------------|-----------------------|-----------------------|-----------------------|-----------------------|-----------------------|
|     | AG      | YE | NL<br>250Hz | Response<br>1 | 500Hz<br>Response<br>2 | 1kHz<br>Response<br>3 | 2kHz<br>Response<br>4 | 3kHz<br>Response<br>5 | 4kHz<br>Response<br>6 | 6kHz<br>Response<br>7 | 8kHz<br>Response<br>8 |
| 181 | 53      | 27 | 115         | 37.562        | 49.034                 | 57                    | 60.002                | 64.024                | 86.123                | 74.897                | 77.302                |
| 49  | 57      | 34 | 115         | 36.211        | 50.928                 | 69                    | 69.123                | 70.754                | 95.032                | 79                    | 76.678                |
| 10  | 57      | 27 | 115         | 35            | 48.879                 | 50                    | 63.896                | 77.032                | 94.003                | 74.945                | 78.932                |
| 55  | 51      | 20 | 115         | 29            | 42.126                 | 43                    | 44                    | 49.878                | 67.995                | 51.143                | 65.321                |
| 34  | 43      | 22 | 116.6       | 34            | 36.016                 | 37                    | 41                    | 50.023                | 57.351                | 46.981                | 60.002                |
| 36  | 64      | 36 | 116.9       | 36.036        | 57.344                 | 60                    | 68.763                | 73.562                | 94.999                | 70.9416               | 83.987                |
| 30  | 50      | 23 | 116.6       | 30.013        | 33.893                 | 35.023                | 38.003                | 46.923                | 69.321                | 53                    | 67                    |
| 1   | 52      | 19 | 116.9       | 31            | 38.041                 | 38.913                | 45.321                | 48.023                | 65.023                | 50.004                | 60.001                |
| 62  | 53      | 14 | 113.5       | 33            | 34.997                 | 34.926                | 38.325                | 42.001                | 67.945                | 46.123                | 65                    |
| 7   | 48      | 21 | 113.5       | 31            | 32                     | 39.028                | 42.765                | 44.086                | 55.043                | 57.012                | 62                    |
| 63  | 36      | 14 | 113.5       | 25.928        | 26                     | 29                    | 30.876                | 37.326                | 38                    | 38.683                | 42.223                |
| 72  | 59      | 26 | 113.5       | 28.956        | 36                     | 43                    | 53.134                | 60.765                | 69                    | 50.004                | 64.128                |
| 17  | 27      | 08 | 96          | 19.012        | 20.979                 | 22.032                | 25.043                | 27.012                | 28                    | 25.004                | 30.006                |
| 81  | 46      | 20 | 96          | 25            | 30.046                 | 34.236                | 35.233                | 35.666                | 57.001                | 39.023                | 44.861                |
| 54  | 35      | 16 | 96          | 25.993        | 31.024                 | 34.921                | 34.563                | 38.043                | 53.991                | 34.768                | 39.213                |
| 47  | 50      | 23 | 96          | 27.565        | 26.593                 | 36.001                | 38.871                | 41.999                | 59.301                | 40.005                | 43.005                |
| 14  | 41      | 21 | 94.4        | 27.033        | 30.999                 | 39                    | 44.002                | 46.124                | 60                    | 44.342                | 47.994                |
| 56  | 31      | 12 | 94.4        | 23.891        | 27.032                 | 29                    | 30.023                | 31.032                | 32.023                | 27                    | 33.786                |
| 173 | 28      | 07 | 94.4        | 16.895        | 21.002                 | 23.014                | 29.021                | 30.856                | 32.011                | 26.5131               | 31.218                |
| 111 | 40      | 15 | 94.4        | 23.246        | 25                     | 28.732                | 29.2                  | 33.444                | 59                    | 36                    | 38                    |
| 92  | 44      | 22 | 94.4        | 26.0124       | 29.076                 | 39.346                | 41.918                | 44                    | 60.3                  | 37.432                | 40.321                |
| 132 | 39      | 20 | 94.4        | 24.320        | 31.032                 | 33.004                | 37.673                | 43.993                | 54.342                | 39.543                | 43                    |
| 117 | 33      | 12 | 93.1        | 25            | 27.59                  | 34.006                | 35.02                 | 37.631                | 56.6                  | 30.5                  | 35                    |
| 51  | 37      | 26 | 93.1        | 25            | 31.007                 | 35.976                | 37.003                | 44.796                | 57.432                | 60.95                 | 56.543                |
| 142 | 45      | 25 | 93.1        | 27.005        | 33                     | 34.041                | 38.234                | 51.022                | 53.161                | 40.230                | 45.118                |
| 137 | 42      | 20 | 93.1        | 28.925        | 29.095                 | 35.005                | 39.052                | 41.654                | 63.002                | 47.1                  | 64                    |
| 31  | 55      | 24 | 93.1        | 37.005        | 39.002                 | 47.761                | 53.118                | 67.450                | 96.035                | 77.098                | 86.23                 |
| 133 | 49      | 21 | 93.1        | 33.303        | 34.005                 | 36.954                | 43.032                | 57                    | 70                    | 49.054                | 64.765                |
| 152 | 25      | 07 | 93.0        | 18.963        | 22.124                 | 25.304                | 27.775                | 29.8                  | 29.432                | 25.62                 | 30.043                |
| 185 | 38      | 15 | 93.0        | 23            | 25                     | 26.554                | 31                    | 33.015                | 37.271                | 32.842                | 33.717                |
| 163 | 55      | 30 | 88.3        | 32            | 38.004                 | 42.043                | 48.003                | 59.674                | 98.063                | 79.582                | 67.210                |
| 70  | 46      | 20 | 88.3        | 33.003        | 41.006                 | 42.757                | 45.161                | 53.502                | 68.321                | 59.231                | 64.321                |
| 5   | 61      | 36 | 97.3        | 35.986        | 39                     | 45.138                | 47.5                  | 55                    | 94                    | 83,654                | 76.032                |

|     |    |    |       |        |        |        |        |        |        |        |         |
|-----|----|----|-------|--------|--------|--------|--------|--------|--------|--------|---------|
| 139 | 22 | 04 | 45    | 25.777 | 22     | 22.271 | 23.4   | 23     | 25.052 | 22.321 | 23      |
| 99  | 26 | 08 | 112.3 | 24     | 24.987 | 26     | 27.985 | 28.903 | 30.965 | 28.964 | 31.765  |
| 159 | 37 | 14 | 112.3 | 21.453 | 23.677 | 27.963 | 31.453 | 36.654 | 39.764 | 36.375 | 36.094  |
| 95  | 31 | 09 | 112.3 | 23.231 | 25.055 | 26     | 27.547 | 28.432 | 39.889 | 28.021 | 30.965  |
| 107 | 32 | 14 | 112.3 | 24.642 | 25.137 | 29.325 | 29     | 30.069 | 34.234 | 33     | 32.874  |
| 23  | 48 | 26 | 112.3 | 35.531 | 36.78  | 40.903 | 45.328 | 49     | 68.765 | 68.975 | 40.653  |
| 168 | 52 | 27 | 112.3 | 28.847 | 33.976 | 43     | 48.943 | 59     | 77.054 | 72.007 | 66.532  |
| 68  | 54 | 31 | 112.3 | 28.784 | 33.696 | 44.324 | 47.012 | 53.001 | 94.324 | 61     | 64.236  |
| 120 | 36 | 14 | 108.3 | 22.206 | 26.345 | 34     | 43.643 | 45.275 | 46.654 | 41.065 | 41.654  |
| 128 | 22 | 04 | 108.3 | 18.456 | 21     | 23.987 | 26.001 | 27.128 | 29.345 | 24.765 | 29.005  |
| 91  | 52 | 25 | 94.5  | 34.719 | 38     | 43.643 | 47.385 | 58     | 92.023 | 58.067 | 64.076  |
| 130 | 49 | 24 | 94.5  | 27.563 | 35.853 | 40.998 | 47     | 51.564 | 70.326 | 45.765 | 50.671  |
| 106 | 44 | 20 | 94.5  | 34     | 33.855 | 57.354 | 47     | 59.087 | 67.987 | 48.643 | 53.8    |
| 141 | 42 | 21 | 94.5  | 28.986 | 29.076 | 35.759 | 47     | 50.986 | 71     | 53.042 | 49.3    |
| 86  | 25 | 07 | 94.5  | 20.543 | 22.859 | 23.543 | 24.394 | 26.852 | 29     | 26.653 | 29.065  |
| 156 | 36 | 13 | 91.1  | 24.895 | 26.743 | 27.408 | 31.001 | 36     | 54.875 | 38.532 | 30.120  |
| 82  | 30 | 08 | 91.1  | 23.026 | 24.987 | 25.453 | 26.478 | 28.067 | 29     | 26.654 | 27.5.09 |
| 158 | 31 | 13 | 91.1  | 23.317 | 24.821 | 27     | 29.543 | 31.084 | 31.074 | 29.054 | 31.107  |
| 21  | 35 | 15 | 91.1  | 29.095 | 32.042 | 34.341 | 39.006 | 37.701 | 41.054 | 35.321 | 31.982  |
| 60  | 29 | 11 | 91.1  | 21.562 | 23.876 | 25.976 | 26.324 | 28.678 | 29     | 27     | 28.876  |
| 165 | 53 | 30 | 91.1  | 32.654 | 34.567 | 44.065 | 50.876 | 54.097 | 80.532 | 51.654 | 73.987  |
| 41  | 35 | 14 | 91.5  | 23.987 | 24.975 | 26.342 | 26.964 | 28.1   | 31.098 | 28.987 | 31.654  |
| 102 | 21 | 03 | 91.5  | 18.876 | 20.909 | 22.876 | 22.654 | 26.763 | 29.202 | 25.3   | 27.984  |
| 27  | 35 | 14 | 91.5  | 22.548 | 23     | 23.764 | 27.054 | 28.986 | 31.345 | 28.876 | 32.098  |
| 100 | 51 | 25 | 91.5  | 36.007 | 37.965 | 44     | 45.5   | 57.965 | 70.980 | 49.987 | 64.999  |
| 76  | 48 | 27 | 91.5  | 30.123 | 32.968 | 40.327 | 45.732 | 53.542 | 78.329 | 59.001 | 75.587  |
| 145 | 53 | 30 | 91.5  | 34.998 | 37.6   | 39.096 | 50.868 | 57.006 | 88.765 | 71.945 | 76.776  |
| 169 | 49 | 23 | 91.5  | 36.987 | 37     | 43.234 | 51.065 | 59.320 | 68.654 | 57.432 | 61.543  |
| 114 | 41 | 21 | 97.2  | 24.654 | 41.675 | 45.876 | 52.001 | 57.5   | 67.432 | 56.976 | 61      |
| 25  | 46 | 20 | 97.2  | 30     | 38.765 | 41.532 | 48.762 | 58.543 | 71.092 | 48.654 | 67.984  |
| 8   | 35 | 13 | 97.2  | 23     | 25.01  | 28.065 | 30     | 31.987 | 33.112 | 27.968 | 39.654  |
| 75  | 51 | 29 | 97.2  | 31.987 | 37.43  | 43.006 | 56.033 | 70.321 | 75.654 | 65.438 | 72.568  |
| 143 | 49 | 22 | 87.3  | 28.435 | 33.654 | 38.843 | 45     | 57.654 | 79     | 65.349 | 73      |
| 154 | 41 | 15 | 87.3  | 27     | 30.04  | 34.764 | 37.654 | 43.23  | 58.023 | 52.654 | 56.432  |
| 53  | 30 | 07 | 87.3  | 24.965 | 26     | 26.976 | 28     | 35.3   | 36     | 28.659 | 34.075  |
| 172 | 52 | 29 | 87.3  | 37.975 | 41.654 | 45.123 | 51.987 | 70.997 | 90     | 77.3   | 82.275  |
| 183 | 53 | 34 | 93.2  | 38     | 44.013 | 48.975 | 55.654 | 60.034 | 98.007 | 67.634 | 83.001  |
| 97  | 34 | 13 | 93.2  | 22.1   | 24.876 | 26.877 | 29.543 | 30.543 | 33.496 | 31.549 | 34.956  |
| 180 | 36 | 15 | 93.2  | 21.849 | 24.866 | 29.654 | 30.543 | 31     | 36.654 | 33.764 | 35.987  |
| 129 | 39 | 14 | 30.2  | 22.854 | 23.543 | 26.879 | 28.764 | 29.9   | 31     | 27.890 | 29.999  |
| 36  | 42 | 12 | 37.8  | 24.453 | 23.875 | 24.098 | 36.548 | 37.872 | 42.836 | 28.099 | 40.543  |
| 2   | 38 | 13 | 44.3  | 22.761 | 23.438 | 25.765 | 27.02  | 28.438 | 32.556 | 28.126 | 31.007  |
| 164 | 38 | 16 | 49.3  | 23.432 | 25.980 | 26.087 | 28.075 | 33.965 | 35.009 | 27.682 | 31.879  |
| 19  | 35 | 19 | 28.4  | 24.765 | 27.799 | 29.543 | 32.987 | 33.117 | 38.765 | 33.432 | 32.259  |
| 147 | 36 | 11 | 38.4  | 22     | 23.432 | 24.543 | 26.3   | 29.088 | 32.665 | 28.608 | 29.764  |

|     |    |    |       |        |        |        |        |        |        |        |        |
|-----|----|----|-------|--------|--------|--------|--------|--------|--------|--------|--------|
| 177 | 30 | 11 | 50.0  | 24.854 | 23.334 | 27     | 29.004 | 34.237 | 36.896 | 32.956 | 33.326 |
| 80  | 35 | 16 | 114.3 | 27.543 | 27.654 | 28.6   | 29.653 | 33.432 | 34.453 | 30.118 | 32.754 |
| 90  | 36 | 13 | 114.3 | 24.701 | 26.865 | 27.4   | 28.601 | 31.554 | 33.987 | 29.874 | 33.760 |
| 48  | 33 | 07 | 114.3 | 23.987 | 24.7   | 25.762 | 27.07  | 29.536 | 31     | 27.638 | 29.176 |
| 166 | 39 | 20 | 114.3 | 22.083 | 25.873 | 32     | 32.098 | 33.385 | 37.432 | 30.549 | 34.964 |
| 157 | 52 | 23 | 114.3 | 39.6   | 45.769 | 49.754 | 57.958 | 63.549 | 87     | 62.376 | 84.749 |
| 109 | 39 | 08 | 114.9 | 22.065 | 23.658 | 25.098 | 26.076 | 27.001 | 28.547 | 25.773 | 29.064 |
| 3   | 19 | 04 | 114.9 | 20.105 | 22.743 | 23.864 | 26.665 | 30.988 | 33.658 | 29.911 | 31.237 |
| 46  | 45 | 13 | 114.9 | 26.001 | 29.055 | 29     | 27.902 | 29.342 | 34.036 | 30.457 | 35.471 |
| 122 | 40 | 15 | 114.9 | 27.986 | 33.345 | 35.4   | 38.432 | 40.654 | 46     | 44.551 | 49.091 |
| 101 | 42 | 20 | 113   | 24.986 | 27     | 46.864 | 48.875 | 60.987 | 71.984 | 48     | 66.765 |
| 89  | 37 | 18 | 113   | 20.862 | 24.874 | 27.543 | 27.985 | 31.506 | 30.675 | 29.849 | 32.990 |
| 20  | 45 | 21 | 113   | 28.531 | 33     | 35.969 | 35.987 | 36.987 | 40.598 | 32.984 | 38.665 |
| 64  | 40 | 15 | 113   | 28.845 | 32     | 33.987 | 36.765 | 37.654 | 40.867 | 39.432 | 43.887 |
| 105 | 42 | 22 | 113   | 28.654 | 33     | 35     | 37.765 | 38.986 | 42.569 | 38.908 | 40.897 |
| 136 | 52 | 25 | 113   | 29.674 | 31.986 | 36.765 | 43.598 | 55.765 | 68.398 | 46.653 | 59.445 |
| 170 | 28 | 10 | 113   | 20.674 | 22.875 | 25.974 | 28.349 | 29.657 | 37.654 | 33     | 34.827 |
| 6   | 37 | 20 | 92.8  | 27.976 | 32.190 | 38.986 | 43.543 | 43.797 | 48.397 | 45.987 | 43.865 |
| 171 | 60 | 35 | 92.8  | 29.730 | 33     | 34.690 | 41.654 | 48.598 | 81.965 | 58.657 | 73     |
| 39  | 56 | 35 | 92.8  | 34.383 | 36.439 | 43.986 | 51.980 | 53.271 | 72.654 | 58     | 68.654 |
| 162 | 32 | 14 | 92.8  | 22.597 | 24.670 | 26.658 | 28.976 | 30.374 | 33.654 | 30.768 | 32.666 |
| 108 | 47 | 24 | 92.8  | 22.965 | 30.418 | 36.976 | 45.569 | 59     | 73     | 56.988 | 70.756 |
| 175 | 48 | 23 | 92.8  | 31.714 | 37.717 | 42     | 50.598 | 57.654 | 69.543 | 58.977 | 64.987 |
| 30  | 46 | 26 | 92.8  | 30.054 | 34     | 40.654 | 45.943 | 52.101 | 70     | 50     | 68.954 |
| 184 | 38 | 16 | 92.8  | 21.999 | 21.984 | 23.875 | 24     | 26.768 | 37.865 | 28.966 | 34.624 |
| 126 | 48 | 23 | 92.8  | 38.887 | 40.997 | 47.876 | 53.876 | 67     | 72.513 | 50.606 | 62.954 |
| 112 | 47 | 28 | 92.8  | 32.986 | 36.096 | 39.654 | 48     | 57.765 | 67.985 | 60.374 | 64.597 |
| 135 | 37 | 19 | 92.3  | 31.486 | 33     | 37.763 | 40.543 | 46.896 | 54.876 | 42     | 49.640 |
| 104 | 59 | 34 | 92.3  | 36.964 | 41.876 | 46     | 53.765 | 59.985 | 69.654 | 51.970 | 70.543 |
| 98  | 33 | 14 | 92.3  | 24     | 27     | 28.654 | 29.387 | 30.886 | 39.768 | 28.329 | 31.866 |
| 125 | 30 | 08 | 92.3  | 22     | 24.982 | 25.876 | 27.176 | 27.986 | 32.987 | 28.965 | 29     |
| 131 | 44 | 23 | 92.3  | 29.653 | 36     | 41.785 | 48.407 | 58.648 | 61.765 | 43.419 | 58     |
| 40  | 47 | 23 | 92.3  | 32.734 | 41.438 | 42.674 | 47.781 | 55.765 | 60.342 | 43.765 | 55.765 |
| 61  | 37 | 13 | 92.3  | 25.965 | 25.965 | 27     | 35.964 | 37.559 | 41.848 | 29.876 | 34.987 |
| 65  | 35 | 12 | 92.3  | 24.543 | 25.326 | 25.027 | 27.489 | 31.765 | 37.865 | 24.654 | 29.542 |
| 178 | 40 | 11 | 92.3  | 23.654 | 25.964 | 27.098 | 33.827 | 33.698 | 39.654 | 27.397 | 37.980 |
| 138 | 50 | 21 | 92.8  | 34     | 38.745 | 44.365 | 51.656 | 57.987 | 69.359 | 50.493 | 60.654 |
| 59  | 45 | 26 | 92.8  | 36.543 | 40.543 | 44.654 | 59.271 | 60.547 | 73.987 | 45.983 | 57.964 |
| 52  | 50 | 21 | 92.8  | 35.985 | 39.988 | 49.986 | 54.659 | 62.984 | 73.659 | 50.328 | 60.386 |
| 174 | 46 | 21 | 92.8  | 33.436 | 39.943 | 41     | 51     | 57.786 | 63.973 | 43.643 | 48.342 |
| 37  | 45 | 20 | 92.8  | 34.765 | 35.643 | 45.653 | 50.644 | 58.524 | 66.248 | 49     | 55.965 |
| 88  | 48 | 17 | 92.8  | 34.876 | 40.487 | 42.876 | 53.976 | 59.863 | 72     | 45.438 | 56     |
| 176 | 38 | 18 | 92.8  | 24.754 | 29.974 | 37.295 | 45.548 | 55.432 | 65.543 | 35     | 47.879 |
| 140 | 42 | 23 | 92.8  | 29.651 | 35.985 | 42     | 49.597 | 59.653 | 67.430 | 40.111 | 51.887 |
| 4   | 39 | 18 | 97.0  | 24.439 | 26.377 | 29.934 | 32     | 37.098 | 47.321 | 33.532 | 44.774 |

|     |    |    |       |        |        |        |        |        |        |        |          |
|-----|----|----|-------|--------|--------|--------|--------|--------|--------|--------|----------|
| 146 | 36 | 16 | 97.0  | 28     | 29.543 | 30.853 | 34.728 | 36.543 | 48.875 | 39.877 | 45.435   |
| 179 | 53 | 30 | 88.0  | 33.266 | 36     | 40.228 | 48.674 | 57.654 | 82.595 | 64.074 | 79.654   |
| 153 | 52 | 34 | 97.0  | 33.964 | 37.853 | 40.214 | 47.193 | 55.384 | 85.923 | 61.998 | 80.923   |
| 73  | 40 | 17 | 97.0  | 30.781 | 34.876 | 36.193 | 44.653 | 53.736 | 71.656 | 57.432 | 78.576   |
| 110 | 41 | 16 | 59.0  | 28.643 | 30.096 | 34.387 | 40     | 46.392 | 58.183 | 45.418 | 53.717   |
| 11  | 49 | 25 | 60.4  | 28.364 | 33.507 | 40.530 | 47     | 57.977 | 70.386 | 51.629 | 63.765   |
| 84  | 51 | 30 | 40.6  | 29.142 | 33.654 | 39     | 48.607 | 53     | 76.636 | 40.507 | 73.418   |
| 150 | 36 | 14 | 114.5 | 24.762 | 27.447 | 29.754 | 30.927 | 34.008 | 41.210 | 28.923 | 39.532   |
| 161 | 52 | 32 | 114.5 | 27.543 | 39     | 48.209 | 50.523 | 56     | 73.392 | 47.507 | 71.654   |
| 151 | 50 | 21 | 114.5 | 28     | 34.965 | 39.932 | 43.764 | 59     | 71.141 | 53.521 | 61.654   |
| 79  | 41 | 18 | 112.2 | 23.954 | 29.876 | 36.210 | 45.154 | 54.362 | 69.653 | 41.543 | 55.876   |
| 155 | 53 | 28 | 112.2 | 30.864 | 40.507 | 47     | 52     | 60.354 | 93.876 | 57.965 | 72.765   |
| 182 | 54 | 33 | 112.2 | 34.005 | 42.876 | 49.015 | 52.321 | 64     | 85.927 | 61.764 | 69       |
| 66  | 35 | 14 | 112.2 | 22     | 23.003 | 25.239 | 26.054 | 29.832 | 34.965 | 32.098 | 37.543   |
| 58  | 31 | 15 | 112.2 | 22     | 24     | 24.762 | 26.085 | 34.503 | 40.654 | 36     | 35.543   |
| 9   | 40 | 19 | 101.7 | 26     | 30.297 | 33.653 | 36.543 | 40.605 | 53.543 | 41     | 47.976   |
| 26  | 43 | 21 | 101.7 | 29.784 | 37.735 | 45     | 48.432 | 49.891 | 78.439 | 40.985 | 54.798   |
| 22  | 39 | 17 | 101.7 | 25.141 | 27.760 | 29.001 | 31     | 33.548 | 40.764 | 35.456 | 37.964   |
| 29  | 49 | 17 | 101.7 | 35.445 | 39.328 | 43.097 | 48     | 59.476 | 72.42  | 50.475 | 61.654   |
| 12  | 47 | 22 | 96.5  | 33993  | 38.714 | 42.432 | 46.765 | 56.538 | 63.543 | 44.643 | 69.965   |
| 57  | 31 | 12 | 96.5  | 22.106 | 24.751 | 26.986 | 30.432 | 32.997 | 40.865 | 34.976 | 33.865   |
| 85  | 52 | 32 | 96.5  | 35.058 | 40.471 | 47.543 | 53.643 | 34.621 | 79.543 | 46,854 | 73.548   |
| 28  | 36 | 14 | 96.5  | 21.318 | 23.093 | 25.654 | 27.587 | 30.432 | 40.065 | 34.654 | 35.876   |
| 160 | 30 | 08 | 96.5  | 20.537 | 23.086 | 23.214 | 26.054 | 27.64  | 30.654 | 27,628 | 29.654   |
| 149 | 42 | 18 | 96.5  | 29.038 | 30     | 37.543 | 46.543 | 54.828 | 77.978 | 50.985 | 70.587   |
| 116 | 56 | 34 | 96.5  | 35.197 | 48     | 53.632 | 54.065 | 68.991 | 99.374 | 69.978 | 84.543   |
| 124 | 57 | 37 | 98.1  | 39.458 | 47     | 52.435 | 57.638 | 58.5   | 80.432 | 50.976 | 72.654   |
| 87  | 21 | 02 | 98.1  | 23.765 | 25.654 | 25.435 | 28.9   | 29.537 | 30.962 | 27.659 | 29.865   |
| 96  | 44 | 23 | 98.1  | 27.985 | 35.543 | 40.256 | 44.872 | 55.406 | 67.753 | 43.852 | 52.008   |
| 167 | 36 | 19 | 98.1  | 24.549 | 24.654 | 25.543 | 26.765 | 28.783 | 35.835 | 27.785 | 30.654   |
| 127 | 50 | 22 | 98.1  | 21.997 | 24.932 | 27.846 | 30.432 | 39.337 | 63.864 | 53.979 | 57.587.7 |
| 134 | 46 | 21 | 98.1  | 25.765 | 26     | 38.648 | 40.951 | 50.132 | 65.438 | 37.967 | 50.987   |
| 13  | 34 | 13 | 93.3  | 22.006 | 24     | 26.5   | 27.876 | 28     | 37.736 | 25.956 | 33.654   |
| 24  | 50 | 24 | 93.3  | 36.765 | 40.223 | 42     | 49.826 | 61.824 | 89.765 | 49.642 | 60       |
| 15  | 61 | 38 | 93.3  | 33     | 40     | 44.5   | 49.543 | 59.883 | 80.743 | 59.876 | 75.569   |
| 42  | 51 | 27 | 93.3  | 31.8   | 39784  | 41.4   | 48     | 63.438 | 69.985 | 48.436 | 67.953   |
| 148 | 39 | 20 | 90.2  | 25.764 | 27.764 | 29.9   | 30     | 32.365 | 39.777 | 32.658 | 35.783   |
| 118 | 44 | 23 | 90.2  | 27.654 | 32.843 | 40.3   | 48.865 | 59.9   | 70.547 | 50.541 | 62.629   |
| 144 | 40 | 12 | 88.2  | 23.654 | 25.385 | 27.5   | 28.763 | 29.653 | 33.558 | 28.854 | 33.432   |
| 67  | 37 | 16 | 88.2  | 23.876 | 25.695 | 27.7   | 29.865 | 33.62  | 39.749 | 30.65  | 36.743   |
| 71  | 47 | 20 | 88.2  | 28     | 32.843 | 38.6   | 40.674 | 45.4   | 71.997 | 49.762 | 68.865   |
| 16  | 31 | 12 | 88.2  | 24.654 | 27.432 | 28.4   | 30.639 | 31.619 | 33.984 | 28     | 31.725   |
| 94  | 41 | 20 | 95.4  | 29.864 | 34.654 | 36.9   | 44     | 57.538 | 63.548 | 36.43  | 42.387   |
| 123 | 51 | 23 | 95.4  | 33.765 | 39     | 48.5   | 55.58  | 58.7   | 79.634 | 48.39  | 65.815   |
| 93  | 55 | 32 | 95.4  | 39.964 | 49     | 51.6   | 54.962 | 60     | 88.839 | 54.964 | 69.926   |

|     |    |    |      |        |        |      |        |        |        |        |        |
|-----|----|----|------|--------|--------|------|--------|--------|--------|--------|--------|
| 78  | 50 | 23 | 58.4 | 28.987 | 33.988 | 35.9 | 40.643 | 44.612 | 57.564 | 41.654 | 45.965 |
| 43  | 35 | 14 | 49.5 | 20.775 | 24.765 | 26.4 | 27.659 | 28.7   | 37.954 | 34.592 | 30.763 |
| 77  | 27 | 10 | 80.0 | 20.760 | 2.098  | 23.9 | 27.547 | 29.734 | 31.695 | 28.776 | 29.957 |
| 83  | 37 | 15 | 55.0 | 23.975 | 24.854 | 25.9 | 26.985 | 28     | 35.985 | 30.978 | 32.754 |
| 113 | 59 | 30 | 90   | 33.987 | 36     | 38.9 | 43.769 | 47.6   | 72.542 | 54.652 | 69.438 |
| 119 | 36 | 18 | 56.0 | 22     | 23.868 | 25.6 | 27     | 30.924 | 35.954 | 31.434 | 33.748 |
| 121 | 60 | 21 | 93.3 | 38.696 | 47.876 | 52   | 59.859 | 67.974 | 93.976 | 51.747 | 73.176 |
| 45  | 62 | 36 | 93.3 | 37.654 | 46.953 | 49.9 | 50.654 | 68.983 | 85.654 | 54.87  | 80.809 |
| 115 | 54 | 27 | 93.3 | 33.904 | 42.975 | 45.7 | 52.876 | 60     | 82.963 | 60.654 | 74.876 |
| 103 | 45 | 16 | 90.2 | 30.976 | 38.631 | 44.7 | 50.754 | 63.947 | 70.954 | 59.454 | 65.520 |
| 44  | 46 | 21 | 90.2 | 30     | 34.7   | 35.6 | 40.658 | 60     | 72.658 | 52.765 | 68.738 |
| 50  | 47 | 22 | 90.2 | 30.549 | 31.537 | 32   | 33.543 | 60.396 | 73.987 | 56.645 | 69.967 |
| 34  | 38 | 11 | 88.2 | 23.375 | 24.432 | 27.6 | 27.677 | 27.828 | 37     | 30.764 | 33.865 |
| 38  | 36 | 16 | 88.2 | 24.643 | 27.564 | 28   | 29.653 | 30.5   | 37.543 | 28.886 | 35.444 |
| 32  | 29 | 09 | 88.2 | 22.391 | 23.052 | 25.6 | 27.763 | 28     | 30.438 | 29.982 | 30.986 |
| 69  | 33 | 10 | 88.2 | 24.653 | 25.437 | 26.3 | 28     | 29.784 | 32.7   | 28.658 | 29.654 |
| 33  | 45 | 17 | 88.2 | 30     | 32.453 | 34.7 | 38.609 | 41.484 | 50.657 | 47.655 | 49.761 |

---

## APPENDIX I

### Hearing Threshold levels among the Respondents in the Quarry.

**Table I1: Mean Hearing Threshold level in the quarry**

| Category of workers | Mean HTL (dBA) | HTL ≤ 25 dBA | HTL > 25 dBA       |
|---------------------|----------------|--------------|--------------------|
|                     |                | N (%)        | N (%)              |
| Q1                  | 40.48          | 14(31.1)     | 31(68.9)           |
| Q2                  | 46.75          | 15(30.6)     | 34(69.4) t = 8.486 |
| Q3                  | 47.92          | 17(40.5)     | 25(59.5) F= 49.513 |
| Q4                  | 47.51          | 14(28.6)     | 35(71.4)           |

Mean hearing threshold = 45.6dB

**Table I2: Ranges of Noise level, Hearing Threshold level of Respondent, Age and Years of exposure in each of the four quarries**

|                               | Q1       | Q2         | Q3         | Q4         |
|-------------------------------|----------|------------|------------|------------|
| Noise level (dBA)             | 38-116.7 | 28.4-108.3 | 40.6-114.9 | 49.0-114.5 |
| Hearing threshold level (dBA) | 09-91    | 11-78      | 11-78      | 15-79      |
| Age(years)                    | 21-65    | 19-52      | 18-58      | 19-60      |
| Years of exposure             | 05-37    | 02-32      | 02-33      | 01-37      |

**Table I3: Number of respondent in the quarries and their mean hearing threshold**

| Quarry | N   | Mean  |
|--------|-----|-------|
| Q1     | 45  | 40.48 |
| Q2     | 49  | 46.75 |
| Q3     | 42  | 47.92 |
| Q4     | 49  | 47.51 |
| Total  | 185 |       |

### One way ANOVA Test

**Table I4: Differences between the Mean values of Hearing Threshold Level of the Respondents of the Four Quarries.**

|                | Sum of Squares | df  | Mean Square | F     | Brown-Forsythe Sig. |
|----------------|----------------|-----|-------------|-------|---------------------|
| Between Groups | 184.278        | 3   | 61.426      | 1.068 | 0.364*              |
| Within Groups  | 11500.180      | 184 | 57.501      |       |                     |
| Total          | 11684.458      | 187 |             |       |                     |

\*Significant at  $p < 0.05$

According to one-way ANOVA test, the differences between the mean values of hearing threshold level of the respondent of the four quarries are not significant ( $F=1.068$ ,  $p = 0.364$ ). This indicates that the differences between the values are close zero; the hearing threshold values are more or less the same. Thus, the respondents at all the quarries were subjected to about the same working conditions and environmental noise. The Brown-Forsythe significant value is generated for data that fails normal distribution test (Karagoz and Saracbasi, 2016).

**APPENDIX J**

**2018 EXPERIMENT (CONTROL SUBJECTS)**

**Table J1: Age, Years of Exposure, Noise level and Hearing Threshold of the Quarry Workers (Control Subjects) in the year 2018**

| NO  | FACTORS |    |    | HEARING THRESHOLD |       |       |       |       |       |       |       |
|-----|---------|----|----|-------------------|-------|-------|-------|-------|-------|-------|-------|
|     | AG      | YE | NL | 250 Hz            | 500Hz | 1 kHz | 2 kHz | 3 kHz | 4 kHz | 6 kHz | 8 kHz |
| 1.  | 42      | 20 | 30 | 20                | 22    | 22    | 23    | 25    | 29    | 23    | 28    |
| 2.  | 49      | 13 | 30 | 25                | 28    | 30    | 32    | 33    | 37    | 34    | 36    |
| 3.  | 50      | 29 | 30 | 26                | 29    | 30    | 32    | 35    | 36    | 30    | 41    |
| 4.  | 27      | 09 | 30 | 23                | 25    | 27    | 27    | 28    | 30    | 26    | 38    |
| 5.  | 40      | 11 | 39 | 25                | 27    | 30    | 33    | 35    | 37    | 28    | 39    |
| 6.  | 45      | 17 | 39 | 32                | 36    | 38    | 40    | 41    | 47    | 37    | 50    |
| 7.  | 59      | 25 | 39 | 33                | 36    | 38    | 40    | 42    | 48    | 36    | 51    |
| 8.  | 49      | 23 | 29 | 28                | 30    | 31    | 33    | 37    | 42    | 35    | 44    |
| 9.  | 41      | 17 | 25 | 27                | 30    | 33    | 35    | 38    | 43    | 38    | 45    |
| 10. | 49      | 23 | 35 | 31                | 32    | 34    | 37    | 40    | 44    | 35    | 46    |
| 11. | 35      | 12 | 45 | 27                | 29    | 31    | 34    | 37    | 39    | 32    | 41    |
| 12. | 24      | 05 | 40 | 25                | 26    | 29    | 31    | 35    | 36    | 37    | 32    |
| 13. | 47      | 15 | 35 | 25                | 27    | 31    | 33    | 35    | 39    | 32    | 41    |
| 14. | 39      | 09 | 38 | 17                | 20    | 22    | 25    | 26    | 27    | 20    | 29    |
| 15. | 44      | 09 | 36 | 23                | 27    | 30    | 31    | 33    | 35    | 32    | 38    |
| 16. | 37      | 15 | 36 | 25                | 27    | 29    | 31    | 33    | 37    | 31    | 40    |



**Table J1 (Continued): Age, Years of Exposure, Noise level and Hearing Threshold of the Quarry Workers (Control Subjects) in the year 2018**

| NO | FACTORS |    |    | HEARING THRESHOLD |       |       |       |       |       |       |       |
|----|---------|----|----|-------------------|-------|-------|-------|-------|-------|-------|-------|
|    | AG      | YE | NL | 250 Hz            | 500Hz | 1 kHz | 2 kHz | 3 kHz | 4 kHz | 6 kHz | 8 kHz |
| 17 | 41      | 19 | 36 | 25                | 26    | 28    | 30    | 32    | 37    | 34    | 39    |
| 18 | 35      | 08 | 38 | 16                | 21    | 23    | 26    | 26    | 28    | 29    | 30    |
| 19 | 39      | 10 | 24 | 24                | 27    | 29    | 31    | 41    | 47    | 39    | 48    |
| 20 | 35      | 10 | 23 | 24                | 26    | 28    | 30    | 30    | 35    | 25    | 30    |
| 21 | 49      | 15 | 24 | 24                | 29    | 37    | 39    | 44    | 48    | 35    | 49    |
| 22 | 30      | 09 | 39 | 17                | 21    | 23    | 26    | 28    | 31    | 24    | 30    |
| 23 | 28      | 04 | 39 | 20                | 24    | 27    | 27    | 30    | 35    | 30    | 38    |
| 24 | 47      | 22 | 38 | 22                | 25    | 33    | 37    | 39    | 41    | 35    | 38    |
| 25 | 47      | 18 | 34 | 22                | 25    | 26    | 28    | 30    | 33    | 25    | 38    |
| 26 | 42      | 18 | 28 | 23                | 25    | 29    | 30    | 32    | 36    | 24    | 39    |
| 27 | 33      | 05 | 47 | 23                | 25    | 28    | 30    | 32    | 40    | 34    | 44    |
| 28 | 54      | 26 | 40 | 28                | 33    | 34    | 36    | 45    | 49    | 39    | 41    |
| 29 | 43      | 20 | 32 | 27                | 27    | 30    | 32    | 34    | 39    | 32    | 41    |
| 30 | 32      | 19 | 32 | 25                | 27    | 29    | 31    | 34    | 38    | 34    | 40    |
| 31 | 46      | 26 | 37 | 24                | 27    | 30    | 33    | 35    | 39    | 25    | 39    |
| 32 | 40      | 18 | 37 | 29                | 31    | 34    | 36    | 38    | 43    | 33    | 46    |
| 33 | 32      | 08 | 38 | 14                | 19    | 23    | 26    | 30    | 35    | 23    | 38    |

**Table J1 (Continued): Age, Years of Exposure, Noise level and Hearing Threshold of the Quarry Workers (Control Subjects) in the year 2018**

| <b>FACTORS</b> |           |           |           | <b>HEARING THRESHOLD</b> |              |              |              |              |              |              |              |
|----------------|-----------|-----------|-----------|--------------------------|--------------|--------------|--------------|--------------|--------------|--------------|--------------|
| <b>NO</b>      | <b>AG</b> | <b>YE</b> | <b>NL</b> | <b>250 Hz</b>            | <b>500Hz</b> | <b>1 kHz</b> | <b>2 kHz</b> | <b>3 kHz</b> | <b>4 kHz</b> | <b>6 kHz</b> | <b>8 kHz</b> |
| 34             | 34        | 12        | 36        | 23                       | 25           | 26           | 30           | 31           | 35           | 29           | 31           |
| 35             | 37        | 09        | 40        | 23                       | 25           | 27           | 30           | 31           | 37           | 29           | 33           |

**2019 EXPERIMENT (CONTROL SUBJECTS)**

**Table J2: Age, Years of Exposure, Noise level and Hearing Threshold of the Quarry Workers (Control Subjects) in the year 2019**

| NO   | FACTORS |    |    | HEARING THRESHOLD |       |       |       |       |       |       |       |
|------|---------|----|----|-------------------|-------|-------|-------|-------|-------|-------|-------|
|      | AG      | YE | NL | 250 Hz            | 500Hz | 1 kHz | 2 kHz | 3 kHz | 4 kHz | 6 kHz | 8 kHz |
| 1.   | 43      | 21 | 30 | 20                | 21    | 22    | 23    | 26    | 28    | 22    | 30    |
| 2.   | 50      | 14 | 30 | 26                | 28    | 30    | 32    | 33    | 37    | 35    | 38    |
| 3.   | 51      | 30 | 30 | 26                | 29    | 30    | 32    | 38    | 39    | 33    | 45    |
| 4.   | 28      | 10 | 30 | 23                | 26    | 27    | 28    | 29    | 33    | 27    | 40    |
| 5.   | 41      | 12 | 39 | 25                | 27    | 30    | 33    | 37    | 38    | 28    | 39    |
| 6    | 46      | 18 | 39 | 31                | 35    | 37    | 40    | 43    | 48    | 39    | 50    |
| 7.   | 60      | 26 | 39 | 35                | 38    | 42    | 43    | 45    | 48    | 38    | 50    |
| 8*.  |         |    |    |                   |       |       |       |       |       |       |       |
| 9.   | 42      | 18 | 25 | 28                | 31    | 33    | 36    | 40    | 44    | 38    | 47    |
| 10.  | 50      | 24 | 35 | 31                | 32    | 34    | 38    | 40    | 45    | 35    | 48    |
| 11.  | 36      | 13 | 45 | 27                | 29    | 32    | 34    | 38    | 40    | 32    | 42    |
| 12.  | 25      | 06 | 40 | 25                | 27    | 29    | 31    | 35    | 39    | 37    | 32    |
| 13*. |         |    |    |                   |       |       |       |       |       |       |       |
| 14   | 40      | 10 | 38 | 17                | 21    | 22    | 26    | 26    | 28    | 20    | 30    |
| 15   | 45      | 10 | 36 | 24                | 28    | 30    | 32    | 33    | 37    | 31    | 39    |

**Table J2 (Continued): Age, Years of Exposure, Noise level and Hearing Threshold of the Quarry Workers (Control**

**Subjects) in the year 2019**

| <b>FACTORS</b> |           |           |           | <b>HEARING THRESHOLD</b> |              |              |              |              |              |              |              |
|----------------|-----------|-----------|-----------|--------------------------|--------------|--------------|--------------|--------------|--------------|--------------|--------------|
| <b>NO</b>      | <b>AG</b> | <b>YE</b> | <b>NL</b> | <b>250 Hz</b>            | <b>500Hz</b> | <b>1 kHz</b> | <b>2 kHz</b> | <b>3 kHz</b> | <b>4 kHz</b> | <b>6 kHz</b> | <b>8 kHz</b> |
| 16             | 38        | 16        | 36        | 26                       | 27           | 30           | 32           | 33           | 39           | 33           | 41           |
| 17             | 42        | 20        | 36        | 26                       | 27           | 28           | 31           | 32           | 39           | 34           | 42           |
| 18             | 36        | 09        | 38        | 16                       | 21           | 23           | 26           | 27           | 29           | 28           | 30           |
| 19*            |           |           |           |                          |              |              |              |              |              |              |              |
| 20             | 36        | 11        | 23        | 25                       | 26           | 29           | 30           | 31           | 36           | 26           | 31           |
| 21             | 50        | 16        | 24        | 25                       | 30           | 39           | 40           | 44           | 50           | 37           | 51           |
| 22             | 31        | 10        | 39        | 18                       | 22           | 23           | 27           | 28           | 33           | 25           | 33           |
| 23             | 29        | 05        | 39        | 20                       | 24           | 27           | 27           | 30           | 36           | 30           | 39           |
| 24             | 48        | 23        | 38        | 23                       | 25           | 34           | 37           | 40           | 43           | 35           | 39           |
| 25             | 48        | 19        | 34        | 23                       | 26           | 27           | 28           | 30           | 33           | 25           | 39           |
| 26             | 43        | 20        | 28        | 24                       | 25           | 30           | 31           | 32           | 37           | 24           | 39           |
| 27             | 34        | 06        | 47        | 23                       | 25           | 28           | 30           | 32           | 41           | 35           | 46           |
| 28             | 55        | 27        | 40        | 28                       | 34           | 35           | 37           | 45           | 50           | 39           | 41           |
| 29*            |           |           |           |                          |              |              |              |              |              |              |              |
| 30             | 33        | 20        | 32        | 27                       | 29           | 30           | 31           | 35           | 41           | 35           | 43           |
| 31             | 47        | 27        | 37        | 25                       | 28           | 30           | 35           | 36           | 40           | 27           | 40           |
| 32             | 41        | 19        | 37        | 30                       | 32           | 34           | 36           | 39           | 45           | 34           | 47           |

**Table J2 (Continued): Age, Years of Exposure, Noise level and Hearing Threshold of the Quarry Workers (Control**

**Subjects) in the year 2019**

| <b>FACTORS</b> |           |           |           | <b>HEARING THRESHOLD</b> |              |              |              |              |              |              |              |
|----------------|-----------|-----------|-----------|--------------------------|--------------|--------------|--------------|--------------|--------------|--------------|--------------|
| <b>NO</b>      | <b>AG</b> | <b>YE</b> | <b>NL</b> | <b>250 Hz</b>            | <b>500Hz</b> | <b>1 kHz</b> | <b>2 kHz</b> | <b>3 kHz</b> | <b>4 kHz</b> | <b>6 kHz</b> | <b>8 kHz</b> |
| 33             | 33        | 09        | 38        | 16                       | 19           | 23           | 27           | 32           | 36           | 24           | 39           |
| 34             | 35        | 13        | 36        | 24                       | 26           | 27           | 30           | 31           | 36           | 29           | 33           |
| 35*            |           |           |           |                          |              |              |              |              |              |              |              |

**\*Absent Subjects in 2019 experiment.**

### Group Statistics of Hearing Threshold of Experimental and Control Groups

Table J3 displays the mean, standard deviation and standard error mean. The mean values of hearing threshold of experimental group at the varying frequencies which are quite higher than the mean values of the threshold of the control group.

**Table J3: Group Statistics of Hearing Threshold of Experimental and Control Groups**

| Hearing Threshold Frequency | Group      | N   | Mean  | Std. Deviation | Std. Error Mean |
|-----------------------------|------------|-----|-------|----------------|-----------------|
| 250 Hz                      | Experiment | 185 | 27.60 | 5.304          | 0.390           |
|                             | Control    | 30  | 24.57 | 4.415          | 0.806           |
| 500 Hz                      | Experiment | 185 | 31.43 | 7.362          | 0.541           |
|                             | Control    | 30  | 27.27 | 4.331          | 0.791           |
| 1 kHz                       | Experiment | 185 | 35.30 | 8.975          | 0.660           |
|                             | Control    | 30  | 29.83 | 4.843          | 0.884           |
| 2 kHz                       | Experiment | 185 | 39.38 | 10.634         | 0.782           |
|                             | Control    | 30  | 32.10 | 4.759          | 0.869           |
| 3 kHz                       | Experiment | 185 | 44.93 | 13.547         | 0.996           |
|                             | Control    | 30  | 34.67 | 5.561          | 1.015           |
| 4 kHz                       | Experiment | 185 | 56.82 | 20.504         | 1.507           |
|                             | Control    | 30  | 38.93 | 5.948          | 1.086           |
| 6 kHz                       | Experiment | 185 | 43.08 | 13.857         | 1.019           |
|                             | Control    | 30  | 31.17 | 5.434          | 0.992           |
| 8 kHz                       | Experiment | 185 | 50.28 | 17.416         | 1.280           |
|                             | Control    | 30  | 40.10 | 6.205          | 1.133           |

The significance of F for equality of variances of experimental group with control group are all less than 0.05. Thus, the null hypotheses that they are equal are rejected. For this reason, the t tests for non-assumption of variance equality were carried out and the results are as shown in the table J4.

**Table J4: Levene's Test for Equality of Variances**

| Hearing Threshold | F      | Significance |
|-------------------|--------|--------------|
| 250Hz             | 5.455  | 0.020        |
| 500Hz             | 14.301 | 0.000        |
| 1 kHz             | 17.951 | 0.000        |
| 2 kHz             | 34.245 | 0.000        |
| 3 kHz             | 49.463 | 0.000        |
| 4 kHz             | 60.333 | 0.000        |
| 6 kHz             | 24.941 | 0.000        |
| 8 kHz             | 60.670 | 0.000        |

**Table J5: T Test of Difference between Hearing Threshold of Experimental and Control Groups for Unequal Variances**

|                  | t     | df      | Sig. (2-tailed) | Mean<br>Difference | Std. Error<br>Difference | 95% Confidence Interval of<br>the Difference |         |
|------------------|-------|---------|-----------------|--------------------|--------------------------|--|---------|
|                  |       |         |                 |                    |                          | Lower  | Upper   |
| <b>Frequency</b> |       |         |                 |                    |                          |  |         |
| <b>250 Hz</b>    | 3.387 | 43.783  | .002            | 3.033              | .895                     | 1.228  | 4.8383  |
| <b>500 Hz</b>    | 4.348 | 60.461  | .000            | 4.166              | .958                     | 1.2283                                       | 6.0821  |
| <b>1 kHz</b>     | 4.953 | 67.019  | .000            | 5.464              | 1.103                    | 3.2619                                       | 7.6660  |
| <b>2 kHz</b>     | 6.232 | 86.090  | .000            | 7.284              | 1.169                    | 4.9603                                       | 9.6072  |
| <b>3 kHz</b>     | 7.216 | 97.461  | .000            | 10.263             | 1.422                    | 7.4405                                       | 13.0856 |
| <b>4 kHz</b>     | 9.626 | 156.735 | .000            | 17.883             | 1.858                    | 14.2132                                      | 21.5525 |
| <b>6 kHz</b>     | 8.375 | 104.173 | .000            | 11.909             | 1.422                    | 9.0892                                       | 14.7288 |
| <b>8 kHz</b>     | 5.955 | 119.636 | .000            | 10.181             | 1.710                    | 6.7959                                       | 13.5662 |

For each frequency in the table above the t value is significant at 0.05 alpha level. Therefore, the null hypotheses that the hearing thresholds of experimental group subjects are not different from the hearing thresholds of the control group subjects are rejected. The differences observed are as a result of relatively higher hearing thresholds of experimental group subjects ascribable to their exposure to noise.

T-TEST GROUPS=grouping\_var(1 2)

/MISSING=ANALYSIS

/VARIABLES=Fre\_250Hz Fre\_500Hz Fre\_1KHz Fre\_2KHz Fre\_3KHz Fre\_4KHz  
Fre\_6KHz Fre\_8KHz

/CRITERIA=CI(.95).

## T-Test

### Notes

|                        |                                   |  |
|------------------------|-----------------------------------|--|
| Output Created         | 13-MAR-2023 12:30:34              |  |
| Comments               |                                   |  |
| Input                  | Data                              | C:\Users\user\Desktop\GIANT\orry<br>JOHNSON\Data_2023.sav  |
|                        | Active Dataset                    | DataSet1   |
|                        | Filter                            | <none>   |
|                        | Weight                            | <none>   |
|                        | Split File                        | <none>   |
|                        | N of Rows in Working Data<br>File | 215  |
| Missing Value Handling | Definition of Missing             | User defined missing values are treated<br>as missing.   |
|                        | Cases Used                        | Statistics for each analysis are based<br>on the cases with no missing or out-of-<br>range data for any variable in the<br>analysis. |



|           |                |  |  |
|-----------|----------------|--|--|
| Syntax    |                | T-TEST GROUPS=grouping_var(1 2)  |  |
|           |                | /MISSING=ANALYSIS  |  |
|           |                | /VARIABLES=Fre_250Hz Fre_500Hz<br>Fre_1KHz Fre_2KHz Fre_3KHz<br>Fre_4KHz Fre_6KHz Fre_8KHz |  |
|           |                | /CRITERIA=CI(.95).   |  |
| Resources | Processor Time | 00:00:00.00  |  |
|           | Elapsed Time   | 00:00:00.03  |  |

### Group Statistics

|           | grouping_var | N   | Mean  | Std. Deviation | Std. Error Mean |
|-----------|--------------|-----|-------|----------------|-----------------|
| Fre_250Hz | 1            | 185 | 27.60 | 5.304          | .390            |
|           | 2            | 30  | 24.57 | 4.415          | .806            |
| Fre_500Hz | 1            | 185 | 31.43 | 7.362          | .541            |
|           | 2            | 30  | 27.27 | 4.331          | .791            |
| Fre_1KHz  | 1            | 185 | 35.30 | 8.975          | .660            |
|           | 2            | 30  | 29.83 | 4.843          | .884            |
| Fre_2KHz  | 1            | 185 | 39.38 | 10.634         | .782            |
|           | 2            | 30  | 32.10 | 4.759          | .869            |
| Fre_3KHz  | 1            | 185 | 44.93 | 13.547         | .996            |
|           | 2            | 30  | 34.67 | 5.561          | 1.015           |
| Fre_4KHz  | 1            | 185 | 56.82 | 20.504         | 1.507           |
|           | 2            | 30  | 38.93 | 5.948          | 1.086           |
| Fre_6KHz  | 1            | 185 | 43.08 | 13.857         | 1.019           |
|           | 2            | 30  | 31.17 | 5.434          | .992            |
| Fre_8KHz  | 1            | 185 | 50.28 | 17.416         | 1.280           |
|           | 2            | 30  | 40.10 | 6.205          | 1.133           |

**Independent Samples Test**

|               |                             | Levene's Test for Equality of Variances |      | t-test for Equality of Means |        |  |  |  |  |  |
|---------------|-----------------------------|---|------|------------------------------|--------|--|--|--|--|--|
|               |                             | F                                       | Sig. | t                            | df     |  |  |  |  |  |
| Fre_2<br>50Hz | Equal variances assumed     | 5.455                                   | .020 | 2.968                        | 213    |  |  |  |  |  |
|               | Equal variances not assumed |   |      | 3.387                        | 43.783 |  |  |  |  |  |
| Fre_5<br>00Hz | Equal variances assumed     | 14.301                                  | .000 | 3.012                        | 213    |  |  |  |  |  |
|               | Equal variances not assumed |   |      | 4.348                        | 60.461 |  |  |  |  |  |
| Fre_1<br>KHz  | Equal variances assumed     | 17.951                                  | .000 | 3.254                        | 213    |  |  |  |  |  |
|               | Equal variances not assumed |   |      | 4.953                        | 67.019 |  |  |  |  |  |
| Fre_2<br>KHz  | Equal variances assumed     | 34.245                                  | .000 | 3.686                        | 213    |  |  |  |  |  |
|               | Equal variances not assumed |   |      | 6.232                        | 86.090 |  |  |  |  |  |

|              |                                   |        |      |       |             |  |  |  |  |  |
|--------------|-----------------------------------|--------|------|-------|-------------|--|--|--|--|--|
| Fre_3<br>KHz | Equal<br>variances<br>assumed     | 49.463 | .000 | 4.087 | 213         |  |  |  |  |  |
|              | Equal<br>variances not<br>assumed |        |      | 7.216 | 97.46<br>1  |  |  |  |  |  |
| Fre_4<br>KHz | Equal<br>variances<br>assumed     | 60.333 | .000 | 4.736 | 213         |  |  |  |  |  |
|              | Equal<br>variances not<br>assumed |        |      | 9.626 | 156.7<br>35 |  |  |  |  |  |
| Fre_6<br>KHz | Equal<br>variances<br>assumed     | 24.941 | .000 | 4.642 | 213         |  |  |  |  |  |
|              | Equal<br>variances not<br>assumed |        |      | 8.375 | 104.1<br>73 |  |  |  |  |  |
| Fre_8<br>KHz | Equal<br>variances<br>assumed     | 60.670 | .000 | 3.164 | 213         |  |  |  |  |  |
|              | Equal<br>variances not<br>assumed |        |      | 5.955 | 119.6<br>36 |  |  |  |  |  |

#### Independent Samples Test

|           |                               |  | t-test for Equality of Means |                 |                       |   |
|-----------|-------------------------------|--|------------------------------|-----------------|-----------------------|---|
|           |                               |  | Sig. (2-tailed)              | Mean Difference | Std. Error Difference | 95% Confidence Interval of the Difference |
| Lower     |                               |  |                              |                 |                       |   |
| Fre_250Hz | Equal<br>variances<br>assumed |  | .003                         | 3.033           | 1.022                 | 1.019                                     |

|           |                             |      |        |       |        |  |
|-----------|-----------------------------|------|--------|-------|--------|--|
|           | Equal variances not assumed | .002 | 3.033  | .895  | 1.228  |  |
| Fre_500Hz | Equal variances assumed     | .003 | 4.166  | 1.383 | 1.440  |  |
|           | Equal variances not assumed | .000 | 4.166  | .958  | 2.249  |  |
| Fre_1KHz  | Equal variances assumed     | .001 | 5.464  | 1.679 | 2.154  |  |
|           | Equal variances not assumed | .000 | 5.464  | 1.103 | 3.262  |  |
| Fre_2KHz  | Equal variances assumed     | .000 | 7.284  | 1.976 | 3.389  |  |
|           | Equal variances not assumed | .000 | 7.284  | 1.169 | 4.960  |  |
| Fre_3KHz  | Equal variances assumed     | .000 | 10.263 | 2.511 | 5.314  |  |
|           | Equal variances not assumed | .000 | 10.263 | 1.422 | 7.441  |  |
| Fre_4KHz  | Equal variances assumed     | .000 | 17.883 | 3.776 | 10.441 |  |
|           | Equal variances not assumed | .000 | 17.883 | 1.858 | 14.213 |  |
| Fre_6KHz  | Equal variances assumed     | .000 | 11.909 | 2.565 | 6.852  |  |
|           | Equal variances not assumed | .000 | 11.909 | 1.422 | 9.089  |  |
| Fre_8KHz  | Equal variances assumed     | .002 | 10.181 | 3.218 | 3.839  |  |
|           | Equal variances not assumed | .000 | 10.181 | 1.710 | 6.796  |  |

**Independent Samples Test**

|  |                              |
|--|------------------------------|
|  | t-test for Equality of Means |
|--|------------------------------|

|           |                             | 95% Confidence Interval of the Difference |
|-----------|-----------------------------|---|
|           |                             | Upper                                     |
| Fre_250Hz | Equal variances assumed     | 5.048                                     |
|           | Equal variances not assumed | 4.838                                     |
| Fre_500Hz | Equal variances assumed     | 6.892                                     |
|           | Equal variances not assumed | 6.082                                     |
| Fre_1KHz  | Equal variances assumed     | 8.774                                     |
|           | Equal variances not assumed | 7.666                                     |
| Fre_2KHz  | Equal variances assumed     | 11.178                                    |
|           | Equal variances not assumed | 9.607                                     |
| Fre_3KHz  | Equal variances assumed     | 15.212                                    |
|           | Equal variances not assumed | 13.086                                    |
| Fre_4KHz  | Equal variances assumed     | 25.325                                    |
|           | Equal variances not assumed | 21.553                                    |
| Fre_6KHz  | Equal variances assumed     | 16.966                                    |
|           | Equal variances not assumed | 14.729                                    |
| Fre_8KHz  | Equal variances assumed     | 16.524                                    |
|           | Equal variances not assumed | 13.566                                    |

**APPENDIX J Continued**

**Control Experiment Data Analysis**

Response 1: Hearing Threshold at 250Hz

In Table J6, the Model F-value of 99.79 implies the model is significant. In this case A, B, C, AB, AC, BC, A<sup>2</sup>, B<sup>2</sup>, C<sup>2</sup> are significant model terms.

**Table J6: ANOVA for Quadratic model for the Hearing Threshold at 250 Hz**

| Source         | Sum of Squares | df | Mean Square | F-value | p-value |             |
|----------------|----------------|----|-------------|---------|---------|-------------|
| <b>Model</b>   | 48.59          | 9  | 5.40        | 99.79   | <0.0001 | significant |
| A-Age          | 2.88           | 1  | 2.88        | 53.23   | <0.0001 |             |
| B-Exposure     | 10.74          | 1  | 10.74       | 198.58  | <0.0001 |             |
| C-Noise Level  | 1.15           | 1  | 1.15        | 21.18   | <0.0001 |             |
| AB             | 1.52           | 1  | 1.52        | 28.06   | <0.0001 |             |
| AC             | 8.03           | 1  | 8.03        | 148.38  | <0.0001 |             |
| BC             | 4.99           | 1  | 4.99        | 92.29   | <0.0001 |             |
| A <sup>2</sup> | 6.87           | 1  | 6.87        | 126.95  | <0.0001 |             |
| B <sup>2</sup> | 0.2300         | 1  | 0.2300      | 4.25    | 0.0474  |             |
| C <sup>2</sup> | 3.22           | 1  | 3.22        | 59.50   | <0.0001 |             |
| Residual       | 1.73           | 32 | 0.0541      |         |         |             |
| Cor Total      | 50.32          | 41 |             |         |         |             |

**Table J7: Model Estimation for 250Hz Threshold**

|                  |        |                          |         |
|------------------|--------|--------------------------|---------|
| <b>Std. Dev.</b> | 0.2326 | <b>R<sup>2</sup></b>     | 0.9656  |
| Mean             | 22.82  | Adjusted R <sup>2</sup>  | 0.9559  |
| C.V. %           | 1.02   | Predicted R <sup>2</sup> | 0.8762  |
|                  |        | Adeq Precision           | 36.8155 |

Response 2: Hearing Threshold at 500 Hz

Table J8 shows that the Model F-value of 81.48 implies the model is significant. In this case A, B, C are significant model terms.

**Table J8: ANOVA for Quadratic model of Hearing Threshold at 500 Hz.**

| Source         | Sum of Squares | df | Mean Square | F-value | p-value |             |
|----------------|----------------|----|-------------|---------|---------|-------------|
| <b>Model</b>   | 53.28          | 9  | 5.92        | 81.48   | <0.0001 | significant |
| A-Age          | 3.84           | 1  | 3.84        | 52.91   | <0.0001 |             |
| B-Exposure     | 1.55           | 1  | 1.55        | 21.35   | <0.0001 |             |
| C-Noise Level  | 0.9363         | 1  | 0.9363      | 12.89   | 0.0011  |             |
| AB             | 0.0595         | 1  | 0.0595      | 0.8194  | 0.3721  |             |
| AC             | 0.0386         | 1  | 0.0386      | 0.5312  | 0.4714  |             |
| BC             | 0.1320         | 1  | 0.1320      | 1.82    | 0.1871  |             |
| A <sup>2</sup> | 0.0684         | 1  | 0.0684      | 0.9413  | 0.3392  |             |
| B <sup>2</sup> | 0.0920         | 1  | 0.0920      | 1.27    | 0.2688  |             |
| C <sup>2</sup> | 0.0276         | 1  | 0.0276      | 0.3796  | 0.5422  |             |
| Residual       | 2.32           | 32 | 0.0727      |         |         |             |
| Cor Total      | 55.60          | 41 |             |         |         |             |

**Table J9: Model Estimation**

|                  |        |                                |         |
|------------------|--------|--------------------------------|---------|
| <b>Std. Dev.</b> | 0.2695 | <b>R<sup>2</sup></b>           | 0.9582  |
| <b>Mean</b>      | 24.90  | <b>Adjusted R<sup>2</sup></b>  | 0.9464  |
| <b>C.V. %</b>    | 1.08   | <b>Predicted R<sup>2</sup></b> | 0.9109  |
|                  |        | <b>Adeq Precision</b>          | 37.2605 |

### Response 3: Hearing Threshold at 1 kHz

In Table J10, the Model F-value of 30.96 implies that the model is significant. In this case A, B, C, AB, AC, BC, A<sup>2</sup>, C<sup>2</sup> are significant model terms.

**Table J10: ANOVA for Quadratic model of Hearing Threshold at 1 kHz**

| Source         | Sum of Squares | df | Mean Square | F-value | p-value |             |
|----------------|----------------|----|-------------|---------|---------|-------------|
| <b>Model</b>   | 130.98         | 9  | 14.55       | 30.96   | <0.0001 | significant |
| A-Age          | 29.58          | 1  | 29.58       | 62.93   | <0.0001 |             |
| B-Exposure     | 8.56           | 1  | 8.56        | 18.22   | 0.0002  |             |
| C-Noise Level  | 17.33          | 1  | 17.33       | 36.86   | <0.0001 |             |
| AB             | 6.41           | 1  | 6.41        | 13.64   | 0.0008  |             |
| AC             | 3.85           | 1  | 3.85        | 8.20    | 0.0073  |             |
| BC             | 10.27          | 1  | 10.27       | 21.84   | <0.0001 |             |
| A <sup>2</sup> | 6.58           | 1  | 6.58        | 14.00   | 0.0007  |             |
| B <sup>2</sup> | 1.65           | 1  | 1.65        | 3.51    | 0.0700  |             |
| C <sup>2</sup> | 12.06          | 1  | 12.06       | 25.65   | <0.0001 |             |
| Residual       | 15.04          | 32 | 0.4701      |         |         |             |
| Cor Total      | 146.02         | 41 |             |         |         |             |

**Table J11: Model Evaluation Result**

|                  |        |                                |         |
|------------------|--------|--------------------------------|---------|
| <b>Std. Dev.</b> | 0.6856 | <b>R<sup>2</sup></b>           | 0.8970  |
| <b>Mean</b>      | 27.00  | <b>Adjusted R<sup>2</sup></b>  | 0.8680  |
| <b>C.V. %</b>    | 2.54   | <b>Predicted R<sup>2</sup></b> | 0.8246  |
|                  |        | <b>Adeq Precision</b>          | 33.0392 |



**Response 4: Hearing Threshold at 2 kHz.**

In Table J12, the Model F-value of 30.61 implies the model is significant. In this case A, AC are significant model terms.

**Table J12: ANOVA for Quadratic model of Hearing Threshold at 2 kHz**

| Source         | Sum of Squares | df | Mean Square | F-value | p-value |             |
|----------------|----------------|----|-------------|---------|---------|-------------|
| <b>Model</b>   | 140.83         | 9  | 15.65       | 30.61   | <0.0001 | significant |
| A-Age          | 42.50          | 1  | 42.50       | 83.13   | <0.0001 |             |
| B-Exposure     | 0.0699         | 1  | 0.0699      | 0.1367  | 0.7140  |             |
| C-Noise Level  | 0.9988         | 1  | 0.9988      | 1.95    | 0.1718  |             |
| AB             | 0.0470         | 1  | 0.0470      | 0.0919  | 0.7637  |             |
| AC             | 8.20           | 1  | 8.20        | 16.04   | 0.0003  |             |
| BC             | 0.1466         | 1  | 0.1466      | 0.2868  | 0.5960  |             |
| A <sup>2</sup> | 0.7368         | 1  | 0.7368      | 1.44    | 0.2387  |             |
| B <sup>2</sup> | 0.0496         | 1  | 0.0496      | 0.0971  | 0.7574  |             |
| C <sup>2</sup> | 0.4618         | 1  | 0.4618      | 0.9034  | 0.3490  |             |
| Residual       | 16.36          | 32 | 0.5112      |         |         |             |
| Cor Total      | 157.19         | 41 |             |         |         |             |

**Table J13: Model Estimation Result**

|           |        |                          |         |
|-----------|--------|--------------------------|---------|
| Std. Dev. | 0.7150 | R <sup>2</sup>           | 0.8959  |
| Mean      | 29.22  | Adjusted R <sup>2</sup>  | 0.8667  |
| C.V. %    | 2.45   | Predicted R <sup>2</sup> | 0.8021  |
|           |        | Adeq Precision           | 34.2971 |

### Response 5: Hearing Threshold at 3 kHz

Table J14 shows the Model F-value of 126.08, which implies that the model is significant. In this case A, C, AB, AC, BC, B<sup>2</sup>, C<sup>2</sup> are significant model terms.

**Table J14: ANOVA for Quadratic Model of Hearing Threshold at 3 kHz**

| Source         | Sum of Squares | df | Mean Square | F-value | p-value |             |
|----------------|----------------|----|-------------|---------|---------|-------------|
| <b>Model</b>   | 272.11         | 9  | 30.23       | 126.08  | <0.0001 | Significant |
| A-Age          | 83.23          | 1  | 83.23       | 347.06  | <0.0001 |             |
| B-Exposure     | 0.5165         | 1  | 0.5165      | 2.15    | 0.1520  |             |
| C-Noise Level  | 2.81           | 1  | 2.81        | 11.73   | 0.0017  |             |
| AB             | 1.53           | 1  | 1.53        | 6.37    | 0.0167  |             |
| AC             | 16.48          | 1  | 16.48       | 68.71   | <0.0001 |             |
| BC             | 1.39           | 1  | 1.39        | 5.79    | 0.0221  |             |
| A <sup>2</sup> | 0.2758         | 1  | 0.2758      | 1.15    | 0.2915  |             |
| B <sup>2</sup> | 2.21           | 1  | 2.21        | 9.20    | 0.0048  |             |
| C <sup>2</sup> | 1.97           | 1  | 1.97        | 8.23    | 0.0072  |             |
| Residual       | 7.67           | 32 | 0.2398      |         |         |             |
| Cor Total      | 279.79         | 41 |             |         |         |             |

**Table J15: Model Estimation Result**

|                  |        |                                |         |
|------------------|--------|--------------------------------|---------|
| <b>Std. Dev.</b> | 0.4897 | <b>R<sup>2</sup></b>           | 0.9726  |
| <b>Mean</b>      | 31.34  | <b>Adjusted R<sup>2</sup></b>  | 0.9649  |
| <b>C.V. %</b>    | 1.56   | <b>Predicted R<sup>2</sup></b> | 0.9492  |
|                  |        | <b>Adeq Precision</b>          | 66.0469 |

**Response 6: Hearing Threshold at 4 kHz**

Table J16 gives the Model F-value of 69.16, which implies that the model is significant. In this case A, C, A<sup>2</sup> are significant model terms.

**Table J16: ANOVA for Quadratic Model of 4 kHz Threshold**

| Source         | Sum of Squares | df | Mean Square | F-value | p-value |             |
|----------------|----------------|----|-------------|---------|---------|-------------|
| <b>Model</b>   | 490.21         | 9  | 54.47       | 69.16   | <0.0001 | significant |
| A-Age          | 65.10          | 1  | 65.10       | 82.66   | <0.0001 |             |
| B-Exposure     | 0.5132         | 1  | 0.5132      | 0.6516  | 0.4255  |             |
| C-Noise Level  | 3.28           | 1  | 3.28        | 4.17    | 0.0495  |             |
| AB             | 2.39           | 1  | 2.39        | 3.04    | 0.0910  |             |
| AC             | 2.43           | 1  | 2.43        | 3.08    | 0.0886  |             |
| BC             | 1.42           | 1  | 1.42        | 1.80    | 0.1888  |             |
| A <sup>2</sup> | 3.51           | 1  | 3.51        | 4.46    | 0.0427  |             |
| B <sup>2</sup> | 0.0204         | 1  | 0.0204      | 0.0260  | 0.8730  |             |
| C <sup>2</sup> | 0.0236         | 1  | 0.0236      | 0.0300  | 0.8635  |             |
| Residual       | 25.20          | 32 | 0.7876      |         |         |             |
| Cor Total      | 515.41         | 41 |             |         |         |             |

**Table J17: Model Estimation Result**

|           |        |                          |         |
|-----------|--------|--------------------------|---------|
| Std. Dev. | 0.8875 | R <sup>2</sup>           | 0.9511  |
| Mean      | 34.56  | Adjusted R <sup>2</sup>  | 0.9373  |
| C.V. %    | 2.57   | Predicted R <sup>2</sup> | 0.8470  |
|           |        | Adeq Precision           | 35.8885 |

**Response 7: Hearing Threshold at 6 kHz**

Table J18 shows that Model F-value of 36.93 implies that the model is significant. In this case A, C, A<sup>2</sup> are significant model terms.

**Table J18: ANOVA for Quadratic Model for 6 kHz Threshold**

| Source         | Sum of Squares | df | Mean Square | F-value | p-value |             |
|----------------|----------------|----|-------------|---------|---------|-------------|
| Model          | 105.64         | 9  | 11.74       | 36.93   | <0.0001 | significant |
| A-Age          | 17.19          | 1  | 17.19       | 54.07   | <0.0001 |             |
| B-Exposure     | 0.6211         | 1  | 0.6211      | 1.95    | 0.1718  |             |
| C-Noise Level  | 2.38           | 1  | 2.38        | 7.50    | 0.0100  |             |
| AB             | 0.4299         | 1  | 0.4299      | 1.35    | 0.2534  |             |
| AC             | 0.9165         | 1  | 0.9165      | 2.88    | 0.0992  |             |
| BC             | 0.1977         | 1  | 0.1977      | 0.6221  | 0.4361  |             |
| A <sup>2</sup> | 1.54           | 1  | 1.54        | 4.86    | 0.0349  |             |
| B <sup>2</sup> | 0.1006         | 1  | 0.1006      | 0.3164  | 0.5777  |             |
| C <sup>2</sup> | 0.6142         | 1  | 0.6142      | 1.93    | 0.1741  |             |
| Residual       | 10.17          | 32 | 0.3178      |         |         |             |
| Cor Total      | 115.81         | 41 |             |         |         |             |

**Table J19: Model Estimation Result**

|                  |        |                                |         |
|------------------|--------|--------------------------------|---------|
| <b>Std. Dev.</b> | 0.5638 | <b>R<sup>2</sup></b>           | 0.9122  |
| <b>Mean</b>      | 27.85  | <b>Adjusted R<sup>2</sup></b>  | 0.8875  |
| <b>C.V. %</b>    | 2.02   | <b>Predicted R<sup>2</sup></b> | 0.8239  |
|                  |        | <b>Adeq Precision</b>          | 27.2190 |

**Response 8: Hearing Threshold at 8 kHz**

Table J20 shows that Model F-value of 33.41 implies that the model is significant. In this case A, A<sup>2</sup> are significant model terms.

**Table J20: ANOVA for Quadratic model**

| Source         | Sum of Squares | df | Mean Square | F-value | p-value |             |
|----------------|----------------|----|-------------|---------|---------|-------------|
| Model          | 305.26         | 9  | 33.92       | 33.41   | <0.0001 | significant |
| A-Age          | 31.96          | 1  | 31.96       | 31.48   | <0.0001 |             |
| B-Exposure     | 0.0182         | 1  | 0.0182      | 0.0179  | 0.8944  |             |
| C-Noise Level  | 3.25           | 1  | 3.25        | 3.20    | 0.0833  |             |
| AB             | 0.0063         | 1  | 0.0063      | 0.0062  | 0.9378  |             |
| AC             | 1.40           | 1  | 1.40        | 1.38    | 0.2491  |             |
| BC             | 0.0362         | 1  | 0.0362      | 0.0356  | 0.8514  |             |
| A <sup>2</sup> | 9.22           | 1  | 9.22        | 9.08    | 0.0050  |             |
| B <sup>2</sup> | 3.28           | 1  | 3.28        | 3.23    | 0.0819  |             |
| C <sup>2</sup> | 0.6751         | 1  | 0.6751      | 0.6650  | 0.4208  |             |
| Residual       | 32.49          | 32 | 1.02        |         |         |             |
| Cor Total      | 337.75         | 41 |             |         |         |             |

**Table J21: Model Estimation Result**

|                  |       |                                |         |
|------------------|-------|--------------------------------|---------|
| <b>Std. Dev.</b> | 1.01  | <b>R<sup>2</sup></b>           | 0.9038  |
| <b>Mean</b>      | 30.87 | <b>Adjusted R<sup>2</sup></b>  | 0.8768  |
| <b>C.V. %</b>    | 3.26  | <b>Predicted R<sup>2</sup></b> | 0.8015  |
|                  |       | <b>Adeq Precision</b>          | 25.6861 |

## APPENDIX K

**Table K1: Developed Models' Performance, Actual Versus Predicted Values (Internal Validation)**

| 250Hz        |                 | 500Hz        |                 | 1kHz         |                 | 2kHz         |                 | 3 kHz        |                 | 4kHz         |                 | 6kHz         |                 | 8kHz         |                 |
|--------------|-----------------|--------------|-----------------|--------------|-----------------|--------------|-----------------|--------------|-----------------|--------------|-----------------|--------------|-----------------|--------------|-----------------|
| Actual Value | Predicted Value | Actual Value | Predicted Value | Actual Value | Predicted Value | Actual Value | Predicted Value | Actual Value | Predicted Value | Actual Value | Predicted Value | Actual Value | Predicted Value | Actual Value | Predicted Value |
| 31.00        | 31.02           | 38.04        | 37.99           | 38.91        | 38.96           | 45.32        | 45.39           | 48.02        | 47.95           | 65.02        | 65.08           | 50.04        | 50.10           | 60.00        | 59.97           |
| 22.76        | 22.69           | 23.44        | 23.39           | 25.77        | 25.92           | 27.02        | 27.06           | 28.44        | 28.46           | 32.56        | 32.49           | 28.13        | 28.15           | 31.01        | 30.99           |
| 20.11        | 20.08           | 22.74        | 22.79           | 23.86        | 23.92           | 26.67        | 26.75           | 30.99        | 31.12           | 33.66        | 33.69           | 29.91        | 29.76           | 31.24        | 31.19           |
| 24.44        | 24.36           | 26.38        | 26.21           | 29.93        | 29.99           | 32.00        | 32.05           | 37.10        | 37.46           | 47.32        | 47.39           | 33.53        | 32.46           | 44.77        | 44.78           |
| 36.00        | 36.04           | 39.00        | 38.98           | 45.14        | 45.06           | 47.50        | 47.48           | 55.00        | 54.65           | 94.00        | 93.97           | 83.65        | 83.68           | 76.03        | 75.97           |
| 28.00        | 27.91           | 32.19        | 31.68           | 39.00        | 38.74           | 43.54        | 43.49           | 43.80        | 42.94           | 48.40        | 47.95           | 46.00        | 46.00           | 43.87        | 42.75           |
| 31.00        | 30.03           | 32.00        | 32.04           | 39.03        | 38.07           | 42.77        | 42.97           | 44.09        | 44.11           | 55.04        | 54.43           | 57.01        | 57.07           | 62.00        | 61.07           |
| 23.00        | 22.42           | 25.01        | 25.06           | 28.07        | 29.01           | 30.00        | 29.83           | 31.99        | 32.01           | 33.11        | 33.18           | 27.97        | 27.07           | 39.65        | 39.49           |
| 26.00        | 25.96           | 30.30        | 30.42           | 33.65        | 33.19           | 36.54        | 36.48           | 40.61        | 40.59           | 53.54        | 54.00           | 41.00        | 40.75           | 47.98        | 47.78           |
| 35.00        | 35.04           | 48.88        | 48.97           | 50.00        | 49.97           | 63.90        | 63.76           | 77.03        | 76.76           | 94.00        | 93.87           | 74.95        | 75.01           | 78.93        | 79.04           |
| 28.36        | 28.45           | 33.51        | 33.45           | 40.53        | 40.58           | 47.00        | 46.88           | 57.98        | 58.08           | 70.39        | 71.05           | 51.63        | 52.04           | 63.77        | 63.96           |
| 33.99        | 33.88           | 38.71        | 37.77           | 42.43        | 41.85           | 46.77        | 46.62           | 56.54        | 56.61           | 63.54        | 63.75           | 44.64        | 43.55           | 69.97        | 70.02           |
| 22.00        | 21.09           | 24.00        | 23.99           | 26.50        | 26.53           | 27.88        | 26.73           | 28.00        | 28.07           | 37.74        | 37.85           | 25.96        | 26.02           | 33.65        | 34.03           |
| 27.03        | 26.56           | 31.00        | 30.93           | 39.00        | 38.97           | 44.00        | 44.08           | 46.12        | 46.95           | 60.00        | 59.74           | 44.34        | 44.63           | 47.99        | 50.04           |
| 33.00        | 33.74           | 40.00        | 40.04           | 44.50        | 44.49           | 49.54        | 49.88           | 59.88        | 60.01           | 80.74        | 81.04           | 59.88        | 59.63           | 75.57        | 76.02           |
| 24.65        | 24.66           | 27.43        | 27.47           | 28.40        | 28.70           | 30.64        | 30.59           | 31.62        | 31.66           | 33.99        | 33.90           | 28.00        | 27.95           | 31.73        | 32.00           |
| 19.01        | 18.91           | 20.98        | 21.01           | 22.03        | 21.98           | 25.04        | 25.44           | 27.01        | 27.05           | 28.00        | 27.98           | 25.00        | 25.05           | 30.01        | 30.04           |
| 30.01        | 29.75           | 33.89        | 34.01           | 35.02        | 34.66           | 38.00        | 37.86           | 46.92        | 47.01           | 69.32        | 68.76           | 53.00        | 53.04           | 67.00        | 66.74           |
| 24.77        | 24.79           | 27.80        | 28.04           | 29.54        | 30.06           | 32.99        | 33.01           | 33.12        | 32.85           | 38.77        | 39.04           | 33.43        | 32.70           | 32.26        | 31.97           |
| 28.53        | 28.45           | 33.00        | 32.57           | 35.97        | 35.66           | 35.99        | 36.23           | 36.99        | 37.03           | 40.60        | 40.56           | 32.98        | 33.43           | 38.67        | 39.01           |

|       |       |       |       |       |       |       |       |       |       |       |       |       |       |       |       |
|-------|-------|-------|-------|-------|-------|-------|-------|-------|-------|-------|-------|-------|-------|-------|-------|
| 29.10 | 28.86 | 32.04 | 31.94 | 34.34 | 34.03 | 39.01 | 38.95 | 37.70 | 37.89 | 41.05 | 40.74 | 35.32 | 34.67 | 31.98 | 32.04 |
| 25.14 | 24.88 | 27.76 | 27.99 | 29.00 | 28.67 | 31.00 | 31.64 | 33.55 | 33.75 | 40.76 | 41.02 | 35.46 | 35.39 | 37.96 | 38.04 |
| 35.53 | 35.58 | 36.78 | 37.02 | 40.90 | 41.02 | 45.33 | 44.98 | 49.00 | 49.25 | 68.77 | 68.79 | 68.98 | 69.35 | 40.65 | 41.00 |
| 36.77 | 36.87 | 40.22 | 39.93 | 42.00 | 42.03 | 49.83 | 50.02 | 61.82 | 62.03 | 89.77 | 89.57 | 49.64 | 50.04 | 60.00 | 59.78 |
| 30.00 | 29.98 | 38.77 | 38.63 | 41.53 | 41.48 | 48.76 | 49.05 | 58.54 | 58.46 | 71.09 | 71.01 | 48.65 | 49.02 | 67.98 | 67.90 |
| 29.78 | 29.75 | 37.74 | 38.00 | 45.00 | 45.23 | 48.43 | 47.96 | 49.89 | 49.54 | 78.44 | 77.96 | 40.99 | 41.43 | 54.80 | 55.07 |
| 22.53 | 22.76 | 23.00 | 22.93 | 23.76 | 24.34 | 27.05 | 26.65 | 28.99 | 29.01 | 31.35 | 30.93 | 28.88 | 28.73 | 32.10 | 31.67 |
| 21.32 | 21.04 | 23.09 | 22.76 | 25.65 | 25.99 | 27.59 | 28.01 | 30.43 | 29.67 | 40.07 | 40.09 | 34.65 | 35.00 | 35.88 | 36.02 |
| 34.45 | 34.42 | 39.33 | 39.33 | 43.10 | 42.98 | 48.00 | 47.95 | 59.48 | 59.04 | 72.42 | 71.87 | 50.48 | 50.51 | 61.65 | 62.34 |
| 30.05 | 29.85 | 34.00 | 33.88 | 40.65 | 41.03 | 45.94 | 46.40 | 52.10 | 52.09 | 70.00 | 70.85 | 50.00 | 49.97 | 68.95 | 69.14 |
| 37.01 | 37.04 | 39.00 | 38.87 | 47.76 | 48.02 | 53.12 | 52.99 | 67.45 | 67.92 | 96.04 | 96.14 | 77.10 | 77.92 | 86.23 | 85.76 |
| 22.39 | 22.11 | 23.05 | 23.08 | 25.60 | 25.50 | 27.76 | 27.82 | 28.00 | 27.86 | 30.44 | 30.01 | 29.98 | 30.01 | 30.99 | 31.02 |
| 30.00 | 29.56 | 32.45 | 32.47 | 34.70 | 35.03 | 38.61 | 39.01 | 41.48 | 41.45 | 50.66 | 51.03 | 47.65 | 48.03 | 49.76 | 49.89 |
| 23.38 | 21.98 | 24.43 | 24.35 | 27.60 | 27.59 | 27.68 | 28.01 | 27.83 | 28.05 | 37.00 | 37.04 | 30.76 | 31.02 | 33.87 | 34.00 |
| 36.04 | 35.96 | 57.34 | 57.02 | 60.00 | 60.01 | 68.76 | 69.01 | 73.56 | 74.04 | 95.00 | 94.69 | 70.94 | 71.04 | 83.99 | 83.75 |
| 24.45 | 24.49 | 23.88 | 24.01 | 24.10 | 23.87 | 36.55 | 36.32 | 37.87 | 37.93 | 42.84 | 42.65 | 28.10 | 27.47 | 40.54 | 40.45 |
| 34.77 | 34.69 | 35.64 | 35.98 | 45.65 | 46.32 | 50.64 | 50.55 | 58.52 | 58.47 | 66.25 | 66.11 | 49.00 | 48.95 | 55.97 | 56.02 |
| 24.64 | 24.90 | 27.56 | 28.54 | 28.00 | 27.94 | 29.65 | 29.73 | 30.50 | 30.53 | 37.54 | 37.57 | 28.89 | 29.01 | 35.44 | 36.03 |
| 34.38 | 33.73 | 36.44 | 35.98 | 43.99 | 44.02 | 51.98 | 60.05 | 53.27 | 52.75 | 72.65 | 72.54 | 58.00 | 57.75 | 68.65 | 69.00 |
| 32.73 | 32.69 | 41.44 | 40.98 | 42.68 | 42.41 | 47.78 | 47.77 | 55.75 | 55.63 | 60.34 | 60.42 | 43.77 | 43.56 | 55.77 | 56.07 |
| 23.99 | 23.54 | 24.98 | 25.33 | 26.34 | 26.13 | 26.96 | 26.70 | 28.10 | 28.19 | 31.10 | 31.07 | 28.99 | 28.88 | 31.65 | 32.03 |
| 31.80 | 31.78 | 39.78 | 40.09 | 41.40 | 41.61 | 48.00 | 48.05 | 63.44 | 64.41 | 69.99 | 69.98 | 48.44 | 47.86 | 67.95 | 68.43 |
| 20.78 | 20.74 | 24.77 | 24.63 | 26.40 | 26.57 | 27.66 | 27.93 | 28.70 | 28.93 | 37.95 | 38.02 | 34.59 | 35.11 | 30.76 | 30.55 |
| 30.00 | 29.65 | 34.70 | 35.40 | 35.60 | 36.03 | 40.66 | 40.94 | 60.00 | 60.09 | 72.66 | 73.04 | 52.77 | 53.01 | 68.74 | 68.53 |
| 37.65 | 37.71 | 46.95 | 47.01 | 49.90 | 50.02 | 50.65 | 51.05 | 68.98 | 68.98 | 85.65 | 86.22 | 54.87 | 55.13 | 80.81 | 81.08 |
| 26.00 | 25.87 | 29.06 | 29.08 | 29.00 | 28.76 | 27.90 | 28.08 | 29.34 | 28.86 | 34.04 | 33.97 | 30.46 | 30.23 | 35.47 | 34.92 |
| 27.57 | 28.01 | 26.59 | 27.05 | 36.00 | 35.52 | 38.87 | 39.03 | 42.00 | 42.38 | 59.30 | 59.39 | 40.01 | 39.92 | 43.01 | 43.06 |
| 23.99 | 23.88 | 24.70 | 25.09 | 25.76 | 26.05 | 27.07 | 26.94 | 29.54 | 30.04 | 31.00 | 31.02 | 27.64 | 27.61 | 29.18 | 28.96 |
| 36.21 | 36.33 | 50.93 | 50.97 | 69.00 | 69.24 | 69.12 | 69.27 | 70.75 | 71.00 | 95.03 | 95.04 | 79.00 | 79.03 | 76.68 | 76.94 |

|       |       |       |       |       |       |       |       |       |       |       |       |       |       |       |       |
|-------|-------|-------|-------|-------|-------|-------|-------|-------|-------|-------|-------|-------|-------|-------|-------|
| 30.55 | 30.34 | 31.54 | 32.07 | 32.00 | 31.87 | 33.54 | 32.65 | 60.40 | 59.99 | 73.99 | 74.02 | 56.65 | 56.73 | 69.97 | 69.99 |
| 25.00 | 24.87 | 31.01 | 31.04 | 35.98 | 36.05 | 37.00 | 36.84 | 44.77 | 44.92 | 57.43 | 57.96 | 60.95 | 61.03 | 56.54 | 57.00 |
| 35.99 | 36.00 | 39.99 | 40.01 | 49.99 | 50.22 | 54.66 | 55.06 | 62.98 | 62.99 | 73.66 | 73.92 | 50.33 | 50.27 | 60.39 | 59.90 |
| 24.97 | 25.00 | 26.00 | 26.02 | 26.98 | 27.09 | 28.00 | 28.08 | 35.30 | 34.96 | 36.00 | 36.02 | 28.66 | 29.02 | 34.08 | 33.99 |
| 25.99 | 26.00 | 31.02 | 31.00 | 34.92 | 35.05 | 34.56 | 35.00 | 38.04 | 37.96 | 53.99 | 54.01 | 34.77 | 35.04 | 39.21 | 39.53 |
| 29.00 | 29.03 | 42.13 | 42.23 | 43.00 | 42.98 | 44.00 | 44.06 | 49.88 | 50.01 | 68.00 | 68.03 | 51.14 | 50.96 | 65.32 | 65.18 |
| 23.89 | 23.54 | 27.03 | 26.67 | 29.00 | 28.65 | 30.02 | 30.00 | 31.03 | 31.05 | 32.02 | 31.96 | 27.00 | 27.87 | 33.79 | 34.82 |
| 22.11 | 21.98 | 24.75 | 25.01 | 26.99 | 27.08 | 30.43 | 30.49 | 33.00 | 32.98 | 40.87 | 40.83 | 34.98 | 34.92 | 33.87 | 34.00 |
| 22.00 | 21.78 | 24.00 | 24.06 | 24.76 | 25.01 | 26.09 | 26.12 | 34.50 | 35.08 | 40.65 | 40.64 | 36.00 | 35.96 | 35.54 | 35.76 |
| 36.54 | 37.00 | 40.54 | 40.58 | 44.65 | 44.72 | 59.27 | 59.02 | 60.55 | 61.00 | 73.99 | 74.03 | 45.98 | 46.02 | 57.96 | 58.00 |
| 21.56 | 22.00 | 23.88 | 24.00 | 25.98 | 26.02 | 26.32 | 25.97 | 28.68 | 29.03 | 29.00 | 29.02 | 27.00 | 26.66 | 28.88 | 29.07 |
| 25.97 | 25.50 | 25.97 | 25.87 | 27.00 | 27.07 | 35.96 | 36.03 | 37.56 | 38.00 | 41.85 | 42.06 | 29.88 | 30.02 | 34.99 | 35.07 |
| 33.00 | 32.95 | 35.00 | 35.06 | 34.93 | 35.07 | 38.33 | 37.98 | 42.00 | 41.97 | 67.95 | 68.01 | 46.12 | 45.76 | 65.00 | 64.96 |
| 25.93 | 25.86 | 26.00 | 26.34 | 29.00 | 29.06 | 30.88 | 31.02 | 37.33 | 37.63 | 38.00 | 38.06 | 38.68 | 38.56 | 42.22 | 42.27 |
| 28.85 | 28.65 | 32.00 | 31.99 | 33.99 | 34.01 | 36.77 | 37.01 | 37.65 | 38.02 | 40.88 | 41.04 | 39.43 | 38.95 | 43.89 | 44.02 |
| 24.54 | 24.45 | 25.33 | 25.03 | 25.03 | 24.99 | 27.49 | 26.60 | 31.77 | 32.00 | 37.87 | 38.03 | 24.65 | 25.04 | 29.54 | 30.04 |
| 22.00 | 22.07 | 23.00 | 23.08 | 25.24 | 25.33 | 26.05 | 26.12 | 29.83 | 29.67 | 34.97 | 34.92 | 32.10 | 32.03 | 37.54 | 38.24 |
| 23.88 | 24.06 | 25.70 | 26.01 | 27.70 | 26.68 | 29.87 | 30.01 | 33.62 | 33.83 | 39.75 | 40.07 | 30.65 | 30.54 | 36.74 | 37.03 |
| 28.78 | 28.37 | 33.70 | 34.05 | 44.32 | 43.98 | 47.01 | 47.00 | 53.00 | 53.14 | 94.32 | 93.96 | 61.00 | 60.57 | 64.24 | 63.86 |
| 24.65 | 25.00 | 25.44 | 26.00 | 26.30 | 26.38 | 28.00 | 28.03 | 29.78 | 30.05 | 32.70 | 33.06 | 28.66 | 28.76 | 29.65 | 30.08 |
| 33.00 | 32.85 | 41.00 | 40.96 | 42.76 | 42.85 | 45.16 | 45.04 | 53.50 | 53.86 | 68.32 | 68.53 | 59.23 | 59.59 | 64.32 | 64.51 |
| 28.00 | 27.95 | 32.84 | 33.01 | 38.60 | 39.04 | 40.67 | 40.23 | 45.40 | 46.03 | 72.00 | 71.81 | 49.76 | 50.15 | 68.87 | 69.05 |
| 28.97 | 29.07 | 36.00 | 36.07 | 43.00 | 42.97 | 53.13 | 52.87 | 60.77 | 61.07 | 69.00 | 68.89 | 50.00 | 49.96 | 64.13 | 64.00 |
| 30.78 | 30.23 | 34.88 | 35.04 | 36.19 | 36.54 | 44.65 | 45.07 | 53.74 | 54.00 | 71.66 | 72.00 | 57.43 | 57.33 | 78.58 | 79.01 |
| 34.00 | 33.87 | 36.02 | 35.6  | 37.00 | 37.02 | 41.00 | 41.06 | 50.02 | 49.76 | 57.35 | 56.99 | 46.98 | 46.50 | 60.00 | 59.99 |
| 31.99 | 31.87 | 37.43 | 36.8  | 43.00 | 42.87 | 56.03 | 55.97 | 70.32 | 70.54 | 75.65 | 75.76 | 65.44 | 64.50 | 72.57 | 72.97 |
| 30.12 | 30.01 | 32.97 | 32.99 | 40.33 | 39.76 | 45.73 | 46.21 | 53.54 | 54.07 | 78.33 | 77.95 | 59.00 | 59.21 | 75.59 | 76.01 |
| 20.76 | 20.83 | 20.98 | 20.76 | 23.90 | 24.00 | 27.55 | 28.12 | 29.73 | 29.50 | 31.70 | 32.00 | 28.78 | 28.95 | 29.96 | 30.03 |
| 28.99 | 29.00 | 33.99 | 34.02 | 35.90 | 36.09 | 40.64 | 40.76 | 44.61 | 44.72 | 57.56 | 58.00 | 41.65 | 42.01 | 45.97 | 46.01 |



|       |       |       |       |       |       |       |       |       |       |       |       |       |       |       |       |
|-------|-------|-------|-------|-------|-------|-------|-------|-------|-------|-------|-------|-------|-------|-------|-------|
| 24.00 | 23.65 | 29.88 | 29.99 | 36.21 | 35.97 | 45.14 | 44.87 | 54.36 | 53.96 | 69.65 | 70.02 | 41.54 | 42.20 | 55.88 | 55.76 |
| 27.54 | 28.01 | 27.65 | 28.05 | 28.60 | 28.89 | 29.65 | 29.99 | 33.43 | 33.05 | 34.45 | 34.42 | 30.12 | 30.00 | 32.75 | 32.87 |
| 25.00 | 24.98 | 30.05 | 30.00 | 34.24 | 34.16 | 35.23 | 34.65 | 35.67 | 35.76 | 57.00 | 56.58 | 39.02 | 38.54 | 44.86 | 45.00 |
| 23.03 | 22.97 | 24.99 | 25.00 | 25.45 | 25.47 | 26.48 | 26.72 | 28.07 | 27.89 | 29.00 | 28.85 | 26.65 | 27.01 | 27.51 | 26.69 |
| 23.96 | 24.06 | 24.85 | 24.99 | 25.90 | 25.80 | 26.99 | 26.79 | 28.00 | 27.95 | 35.99 | 36.02 | 30.98 | 31.08 | 32.76 | 33.01 |
| 29.14 | 28.65 | 33.65 | 34.08 | 39.00 | 39.07 | 48.61 | 49.00 | 53.00 | 54.86 | 76.64 | 77.00 | 40.51 | 40.53 | 73.42 | 72.97 |
| 38.06 | 38.08 | 40.47 | 40.03 | 47.54 | 48.07 | 53.64 | 54.03 | 34.62 | 35.01 | 79.54 | 80.02 | 46.85 | 47.01 | 73.55 | 74.01 |
| 20.54 | 20.99 | 22.86 | 23.03 | 23.54 | 24.02 | 24.39 | 23.87 | 26.85 | 25.65 | 29.00 | 29.03 | 26.65 | 27.01 | 29.07 | 29.01 |
| 23.77 | 24.01 | 25.65 | 25.51 | 25.44 | 24.99 | 28.90 | 28.52 | 29.54 | 29.94 | 30.96 | 31.00 | 27.66 | 28.03 | 29.87 | 29.72 |
| 34.88 | 35.01 | 40.49 | 40.73 | 42.88 | 42.96 | 53.98 | 53.76 | 59.86 | 60.02 | 72.00 | 72.03 | 45.44 | 44.98 | 56.00 | 56.12 |
| 20.86 | 21.12 | 24.87 | 24.93 | 27.54 | 27.49 | 27.99 | 28.02 | 31.51 | 31.55 | 30.68 | 30.67 | 29.85 | 30.41 | 32.99 | 32.54 |
| 24.70 | 25.01 | 26.87 | 26.69 | 27.40 | 26.78 | 28.60 | 29.02 | 31.55 | 32.01 | 33.99 | 34.01 | 29.87 | 30.01 | 33.76 | 34.06 |
| 34.72 | 35.03 | 38.00 | 37.68 | 43.64 | 43.76 | 47.39 | 46.65 | 58.00 | 57.88 | 92.02 | 92.01 | 58.07 | 58.02 | 64.08 | 63.98 |
| 26.01 | 25.87 | 29.08 | 28.98 | 39.35 | 38.65 | 41.92 | 42.03 | 44.00 | 43.96 | 60.30 | 60.20 | 37.43 | 36.76 | 40.32 | 40.65 |
| 39.97 | 40.01 | 49.00 | 48.87 | 51.60 | 51.61 | 54.96 | 55.02 | 60.00 | 60.09 | 88.84 | 89.01 | 54.96 | 55.71 | 69.93 | 41.01 |
| 29.86 | 28.75 | 34.65 | 35.01 | 36.90 | 37.03 | 44.00 | 43.96 | 57.54 | 57.74 | 63.55 | 64.02 | 36.43 | 37.86 | 42.39 | 41.88 |
| 23.23 | 23.04 | 25.06 | 24.65 | 26.00 | 25.98 | 27.55 | 27.54 | 28.43 | 28.76 | 39.89 | 40.01 | 28.02 | 27.86 | 30.97 | 31.12 |
| 27.99 | 27.56 | 35.54 | 35.65 | 40.26 | 39.99 | 44.87 | 45.02 | 55.41 | 55.24 | 67.75 | 67.53 | 43.85 | 44.09 | 52.01 | 52.02 |
| 22.10 | 21.75 | 24.88 | 25.54 | 26.88 | 27.01 | 29.54 | 29.57 | 30.54 | 30.99 | 33.50 | 33.40 | 31.55 | 31.88 | 34.96 | 34.86 |
| 22.00 | 22.12 | 24.98 | 24.87 | 25.88 | 26.05 | 27.18 | 27.03 | 27.99 | 28.09 | 32.99 | 33.01 | 28.97 | 29.04 | 29.00 | 28.92 |
| 24.00 | 23.87 | 24.99 | 25.02 | 26.00 | 26.02 | 27.99 | 28.02 | 28.90 | 29.00 | 30.97 | 30.69 | 28.96 | 29.21 | 31.77 | 32.04 |
| 36.01 | 35.98 | 37.97 | 38.01 | 44.00 | 43.97 | 45.50 | 44.98 | 57.97 | 58.25 | 70.98 | 71.01 | 49.99 | 50.02 | 65.00 | 64.83 |
| 24.99 | 25.33 | 27.00 | 27.02 | 46.86 | 47.00 | 48.88 | 48.96 | 60.99 | 61.06 | 71.98 | 71.95 | 48.00 | 47.87 | 66.77 | 67.03 |
| 18.88 | 18.99 | 20.91 | 21.08 | 22.88 | 22.56 | 22.65 | 22.85 | 26.76 | 27.03 | 29.20 | 29.77 | 25.30 | 25.34 | 27.98 | 28.02 |
| 30.98 | 31.03 | 38.63 | 39.04 | 44.70 | 44.68 | 50.75 | 51.05 | 63.95 | 64.06 | 70.95 | 71.01 | 59.45 | 59.42 | 65.52 | 66.03 |
| 36.96 | 37.01 | 41.88 | 42.01 | 46.00 | 45.87 | 53.77 | 53.89 | 59.99 | 60.01 | 69.65 | 70.01 | 51.97 | 52.01 | 70.54 | 70.77 |
| 28.65 | 29.01 | 33.00 | 33.01 | 35.00 | 34.98 | 37.77 | 37.98 | 38.99 | 39.00 | 42.60 | 42.66 | 38.91 | 38.65 | 40.90 | 41.02 |
| 34.00 | 33.98 | 33.86 | 33.96 | 57.35 | 57.35 | 47.00 | 46.98 | 59.09 | 59.04 | 67.99 | 68.06 | 48.64 | 49.00 | 53.80 | 54.01 |
| 24.64 | 24.56 | 25.14 | 24.99 | 29.33 | 29.43 | 29.00 | 28.99 | 30.07 | 30.02 | 34.23 | 34.32 | 33.00 | 33.01 | 32.87 | 33.72 |

|       |       |       |       |       |       |       |       |       |       |       |       |       |       |       |       |
|-------|-------|-------|-------|-------|-------|-------|-------|-------|-------|-------|-------|-------|-------|-------|-------|
| 22.97 | 23.00 | 30.42 | 30.44 | 36.98 | 37.02 | 45.57 | 46.02 | 59.00 | 59.01 | 73.00 | 72.99 | 56.99 | 56.87 | 70.76 | 71.00 |
| 22.07 | 22.10 | 23.66 | 23.98 | 25.10 | 24.99 | 26.08 | 25.98 | 27.00 | 29.87 | 28.55 | 29.03 | 25.77 | 25.99 | 29.06 | 28.86 |
| 28.64 | 29.03 | 30.10 | 30.03 | 34.39 | 34.19 | 40.00 | 39.98 | 46.39 | 46.03 | 58.18 | 57.65 | 45.42 | 44.98 | 53.72 | 54.09 |
| 23.25 | 23.23 | 25.00 | 24.98 | 28.73 | 29.05 | 29.20 | 28.96 | 33.44 | 33.01 | 59.00 | 59.01 | 36.00 | 35.94 | 38.00 | 37.02 |
| 32.99 | 32.54 | 36.10 | 35.99 | 39.65 | 40.01 | 48.00 | 48.02 | 57.77 | 58.65 | 67.99 | 68.01 | 60.37 | 59.98 | 64.60 | 63.98 |
| 33.99 | 34.01 | 36.00 | 35.87 | 38.90 | 38.91 | 43.77 | 44.04 | 47.60 | 47.62 | 72.54 | 72.58 | 54.65 | 55.04 | 69.44 | 68.96 |
| 24.65 | 25.01 | 41.68 | 41.79 | 45.88 | 45.98 | 52.00 | 51.67 | 57.50 | 57.78 | 67.43 | 66.79 | 56.98 | 57.08 | 61.00 | 60.96 |
| 33.90 | 34.01 | 42.98 | 42.99 | 45.70 | 46.04 | 52.88 | 53.02 | 60.00 | 59.66 | 82.96 | 83.02 | 60.65 | 61.07 | 74.88 | 75.01 |
| 35.20 | 34.87 | 48.00 | 47.87 | 53.63 | 53.54 | 54.07 | 53.97 | 68.99 | 69.01 | 99.37 | 99.01 | 69.98 | 70.04 | 84.54 | 84.45 |
| 25.00 | 24.95 | 27.59 | 28.09 | 34.01 | 33.94 | 35.02 | 34.97 | 37.63 | 37.53 | 56.60 | 57.01 | 30.50 | 31.00 | 35.00 | 34.74 |
| 27.65 | 28.00 | 32.84 | 32.56 | 40.30 | 39.98 | 48.87 | 49.01 | 59.90 | 60.12 | 70.55 | 71.03 | 50.54 | 51.04 | 62.63 | 62.69 |
| 22.00 | 21.55 | 23.87 | 24.01 | 25.60 | 26.10 | 27.00 | 26.89 | 30.92 | 31.01 | 35.95 | 36.00 | 31.43 | 31.34 | 33.75 | 34.03 |
| 22.21 | 22.03 | 26.35 | 26.49 | 34.00 | 34.10 | 43.64 | 43.58 | 42.28 | 42.02 | 46.65 | 47.01 | 41.07 | 40.65 | 41.65 | 41.98 |
| 38.70 | 38.96 | 47.88 | 47.97 | 52.00 | 51.65 | 59.86 | 59.99 | 67.97 | 68.32 | 93.98 | 94.10 | 51.75 | 51.85 | 73.18 | 72.99 |
| 27.99 | 28.04 | 33.35 | 32.75 | 35.40 | 35.03 | 38.43 | 38.97 | 40.65 | 41.43 | 46.00 | 45.97 | 44.55 | 45.00 | 49.09 | 48.97 |
| 33.77 | 34.03 | 39.00 | 38.96 | 48.50 | 48.65 | 55.58 | 55.55 | 58.70 | 59.09 | 79.63 | 79.54 | 48.39 | 48.06 | 65.82 | 66.01 |
| 39.46 | 40.01 | 47.00 | 46.87 | 52.44 | 52.05 | 57.64 | 58.54 | 58.50 | 58.79 | 80.43 | 80.44 | 50.98 | 51.00 | 72.65 | 73.00 |
| 22.00 | 21.98 | 24.98 | 25.02 | 25.88 | 26.02 | 27.18 | 26.79 | 27.99 | 28.09 | 32.99 | 33.06 | 28.97 | 29.52 | 29.00 | 28.97 |
| 38.89 | 39.02 | 41.00 | 40.95 | 47.88 | 48.04 | 53.88 | 54.04 | 67.00 | 67.07 | 72.51 | 73.18 | 50.61 | 51.08 | 62.95 | 63.00 |
| 22.00 | 22.01 | 24.93 | 25.03 | 27.85 | 28.01 | 30.43 | 30.09 | 39.34 | 38.92 | 63.86 | 64.03 | 53.98 | 54.00 | 57.59 | 58.03 |
| 18.46 | 19.00 | 21.00 | 20.76 | 23.99 | 23.64 | 26.00 | 25.99 | 27.13 | 27.02 | 29.35 | 29.96 | 24.77 | 25.15 | 29.01 | 28.89 |
| 22.85 | 22.90 | 23.54 | 24.00 | 26.88 | 27.20 | 28.76 | 28.52 | 29.90 | 29.67 | 31.00 | 30.87 | 27.89 | 28.05 | 30.00 | 29.87 |
| 27.56 | 28.00 | 35.85 | 35.95 | 41.00 | 40.59 | 47.00 | 46.69 | 51.56 | 51.45 | 70.33 | 69.98 | 45.77 | 46.02 | 50.67 | 51.11 |
| 29.65 | 29.87 | 36.00 | 35.65 | 41.79 | 42.01 | 48.41 | 48.04 | 58.65 | 58.45 | 61.77 | 62.01 | 43.42 | 42.99 | 58.00 | 57.86 |
| 24.32 | 23.98 | 31.03 | 30.98 | 33.00 | 32.86 | 37.67 | 38.43 | 43.99 | 44.07 | 54.32 | 54.33 | 39.54 | 40.42 | 43.00 | 42.78 |
| 33.03 | 32.98 | 34.01 | 33.65 | 36.95 | 37.26 | 43.03 | 42.87 | 57.00 | 56.58 | 70.00 | 69.97 | 49.05 | 49.10 | 64.77 | 65.00 |
| 25.77 | 25.78 | 26.00 | 25.69 | 38.65 | 39.00 | 40.95 | 41.06 | 50.13 | 49.95 | 65.44 | 64.98 | 37.97 | 36.87 | 50.99 | 51.07 |
| 31.49 | 31.54 | 33.00 | 32.64 | 37.76 | 38.02 | 40.54 | 41.65 | 46.90 | 47.04 | 54.88 | 55.25 | 42.00 | 41.87 | 49.64 | 49.95 |
| 29.67 | 29.50 | 31.99 | 32.06 | 36.77 | 37.76 | 43.60 | 42.02 | 55.77 | 58.00 | 68.40 | 67.74 | 46.65 | 47.01 | 59.45 | 49.98 |

|       |       |       |       |       |       |       |       |       |       |       |       |       |       |       |       |
|-------|-------|-------|-------|-------|-------|-------|-------|-------|-------|-------|-------|-------|-------|-------|-------|
| 28.93 | 29.09 | 29.10 | 28.85 | 35.01 | 34.97 | 39.05 | 39.01 | 41.65 | 42.04 | 63.00 | 63.08 | 47.10 | 46.93 | 64.00 | 63.56 |
| 34.00 | 33.96 | 38.75 | 38.69 | 44.37 | 44.85 | 51.66 | 52.01 | 57.99 | 58.44 | 69.36 | 69.02 | 50.49 | 50.57 | 60.65 | 61.00 |
| 21.78 | 21.62 | 22.00 | 21.59 | 22.27 | 22.74 | 23.40 | 23.87 | 23.00 | 22.78 | 25.05 | 24.96 | 22.32 | 22.34 | 23.00 | 22.90 |
| 29.65 | 29.64 | 35.99 | 35.94 | 42.00 | 41.67 | 49.60 | 50.02 | 59.65 | 60.01 | 67.43 | 67.04 | 40.11 | 39.58 | 51.89 | 52.07 |
| 28.99 | 29.00 | 29.08 | 28.98 | 35.76 | 36.00 | 47.00 | 47.03 | 50.99 | 50.98 | 71.00 | 71.05 | 53.04 | 52.87 | 49.30 | 48.97 |
| 27.01 | 27.00 | 33.00 | 32.56 | 34.04 | 34.00 | 38.23 | 38.03 | 51.02 | 50.98 | 53.16 | 52.76 | 40.23 | 40.02 | 45.12 | 44.76 |
| 28.44 | 28.24 | 33.66 | 34.03 | 38.84 | 39.01 | 45.00 | 45.10 | 57.65 | 58.02 | 79.00 | 78.59 | 65.35 | 64.86 | 73.00 | 72.94 |
| 23.65 | 23.97 | 25.39 | 25.26 | 27.50 | 27.77 | 28.76 | 28.92 | 29.65 | 30.02 | 33.56 | 33.60 | 28.85 | 29.01 | 33.43 | 33.40 |
| 35.00 | 34.99 | 37.60 | 37.59 | 39.10 | 39.04 | 50.87 | 50.76 | 57.01 | 56.95 | 88.77 | 89.02 | 71.95 | 72.00 | 76.78 | 77.02 |
| 28.00 | 27.75 | 29.54 | 30.04 | 30.85 | 31.02 | 34.73 | 35.01 | 36.54 | 36.73 | 48.88 | 48.93 | 39.88 | 40.01 | 45.44 | 45.46 |
| 22.00 | 21.78 | 23.43 | 23.41 | 24.54 | 25.00 | 26.30 | 25.59 | 29.09 | 28.99 | 32.67 | 33.07 | 28.61 | 28.52 | 29.76 | 30.04 |
| 25.76 | 25.77 | 27.76 | 27.89 | 29.90 | 30.08 | 30.00 | 30.03 | 32.37 | 32.11 | 39.78 | 40.03 | 32.66 | 32.65 | 35.78 | 36.00 |
| 29.04 | 29.00 | 30.00 | 29.76 | 37.54 | 37.89 | 46.54 | 46.59 | 54.83 | 55.01 | 77.98 | 78.07 | 50.99 | 51.07 | 70.59 | 71.00 |
| 24.76 | 25.07 | 27.45 | 28.09 | 29.75 | 28.98 | 30.93 | 31.06 | 34.01 | 33.98 | 41.21 | 40.76 | 28.92 | 29.08 | 39.53 | 40.01 |
| 28.00 | 27.90 | 34.97 | 34.99 | 39.93 | 40.02 | 43.76 | 44.13 | 59.00 | 58.88 | 71.14 | 71.06 | 53.52 | 54.00 | 61.65 | 62.07 |
| 18.96 | 19.04 | 22.12 | 22.08 | 25.30 | 24.98 | 27.78 | 28.02 | 29.80 | 29.81 | 29.43 | 29.42 | 25.62 | 26.06 | 30.04 | 29.98 |
| 33.96 | 34.04 | 37.85 | 38.23 | 40.21 | 39.99 | 47.19 | 47.03 | 55.38 | 55.02 | 85.92 | 86.01 | 62.00 | 62.02 | 80.92 | 81.43 |
| 27.00 | 26.68 | 30.04 | 29.95 | 34.76 | 35.01 | 37.65 | 38.03 | 43.23 | 42.76 | 58.02 | 58.02 | 52.65 | 53.06 | 56.43 | 56.23 |
| 30.86 | 30.80 | 40.51 | 41.04 | 47.00 | 46.87 | 52.00 | 52.00 | 60.35 | 59.98 | 93.88 | 94.04 | 57.97 | 60.00 | 72.77 | 73.05 |
| 24.90 | 25.01 | 26.74 | 27.06 | 27.41 | 27.75 | 31.00 | 31.07 | 36.00 | 35.98 | 54.88 | 55.01 | 38.53 | 39.76 | 30.12 | 30.00 |
| 39.60 | 39.62 | 45.77 | 46.58 | 49.75 | 50.02 | 57.96 | 58.00 | 63.55 | 64.02 | 87.00 | 86.98 | 62.38 | 63.06 | 84.75 | 85.01 |
| 23.32 | 23.30 | 24.82 | 25.00 | 27.00 | 27.02 | 29.54 | 30.05 | 31.08 | 31.03 | 31.07 | 30.65 | 29.05 | 29.09 | 31.11 | 30.65 |
| 21.45 | 21.59 | 23.68 | 24.06 | 27.96 | 28.68 | 31.45 | 31.07 | 36.65 | 36.76 | 39.76 | 40.03 | 36.38 | 35.98 | 36.09 | 35.98 |
| 20.54 | 20.84 | 23.09 | 22.87 | 23.21 | 22.96 | 26.05 | 25.71 | 27.64 | 27.68 | 30.65 | 31.02 | 27.63 | 27.99 | 29.65 | 29.51 |
| 27.54 | 28.06 | 39.00 | 38.76 | 48.21 | 47.77 | 50.52 | 50.52 | 56.00 | 55.98 | 73.39 | 72.76 | 47.51 | 48.04 | 71.65 | 72.00 |
| 22.60 | 22.50 | 24.67 | 24.70 | 26.66 | 26.68 | 28.98 | 29.03 | 30.37 | 30.21 | 33.65 | 33.55 | 30.77 | 30.56 | 32.67 | 32.96 |
| 32.00 | 31.99 | 38.00 | 38.01 | 42.04 | 41.87 | 48.00 | 47.76 | 59.67 | 60.01 | 98.06 | 99.10 | 79.58 | 79.95 | 67.21 | 66.69 |
| 23.43 | 23.24 | 25.98 | 25.89 | 26.09 | 26.00 | 28.08 | 27.98 | 33.97 | 34.00 | 35.01 | 34.99 | 27.68 | 28.01 | 31.88 | 31.99 |
| 32.65 | 32.67 | 34.57 | 35.00 | 44.07 | 43.92 | 50.88 | 50.54 | 54.10 | 54.06 | 80.53 | 80.53 | 51.65 | 51.70 | 73.99 | 74.00 |

|       |       |       |       |       |       |       |       |       |       |       |       |       |       |       |       |
|-------|-------|-------|-------|-------|-------|-------|-------|-------|-------|-------|-------|-------|-------|-------|-------|
| 22.08 | 21.96 | 25.87 | 26.01 | 32.00 | 32.10 | 32.10 | 31.96 | 33.39 | 33.10 | 37.43 | 37.53 | 30.55 | 30.57 | 34.96 | 35.00 |
| 24.55 | 24.97 | 24.65 | 25.00 | 25.54 | 25.51 | 26.76 | 27.00 | 28.78 | 28.58 | 35.83 | 35.99 | 27.79 | 27.80 | 30.65 | 30.69 |
| 28.85 | 29.02 | 33.98 | 34.04 | 43.00 | 42.89 | 48.94 | 49.01 | 59.00 | 58.87 | 77.05 | 77.03 | 77.01 | 76.99 | 66.53 | 66.59 |
| 36.99 | 37.04 | 37.00 | 37.06 | 43.23 | 42.65 | 51.07 | 50.98 | 59.32 | 59.06 | 68.65 | 69.00 | 57.43 | 57.33 | 61.54 | 61.75 |
| 20.67 | 20.98 | 22.88 | 22.97 | 25.97 | 25.99 | 28.35 | 28.30 | 29.66 | 29.97 | 37.65 | 37.45 | 33.00 | 32.97 | 34.83 | 35.00 |
| 29.73 | 30.02 | 33.00 | 33.05 | 34.69 | 35.01 | 41.65 | 41.85 | 48.60 | 48.50 | 81.97 | 82.00 | 58.66 | 58.69 | 73.00 | 72.76 |
| 37.98 | 38.03 | 41.65 | 41.63 | 45.12 | 44.79 | 51.99 | 52.02 | 71.00 | 70.99 | 90.00 | 90.01 | 77.30 | 77.35 | 82.28 | 82.25 |
| 16.90 | 16.78 | 21.00 | 20.99 | 23.01 | 22.96 | 29.02 | 29.00 | 30.86 | 30.88 | 32.01 | 32.00 | 26.51 | 26.59 | 31.22 | 31.05 |
| 33.44 | 33.03 | 39.94 | 40.01 | 41.00 | 41.02 | 51.00 | 51.05 | 57.79 | 58.00 | 63.97 | 63.58 | 43.64 | 43.60 | 48.34 | 48.32 |
| 31.71 | 31.78 | 37.72 | 37.81 | 42.00 | 41.99 | 50.60 | 50.55 | 57.65 | 57.67 | 69.54 | 70.00 | 58.98 | 59.00 | 64.99 | 65.01 |
| 24.75 | 24.66 | 29.97 | 30.08 | 37.30 | 37.25 | 45.55 | 46.01 | 55.43 | 55.40 | 65.54 | 65.99 | 35.00 | 34.50 | 47.88 | 47.89 |
| 24.85 | 24.67 | 23.33 | 23.32 | 27.00 | 27.02 | 29.00 | 29.02 | 34.24 | 34.33 | 36.90 | 37.00 | 33.00 | 33.02 | 33.33 | 33.25 |
| 23.65 | 24.00 | 25.96 | 26.01 | 27.10 | 27.04 | 33.83 | 33.99 | 33.70 | 33.80 | 39.65 | 40.00 | 27.40 | 27.43 | 38.00 | 38.38 |
| 33.27 | 33.20 | 36.00 | 36.04 | 40.23 | 40.29 | 48.67 | 48.77 | 57.65 | 57.67 | 82.60 | 82.62 | 64.07 | 64.03 | 79.65 | 79.90 |
| 21.85 | 21.89 | 24.87 | 24.99 | 29.65 | 29.67 | 30.54 | 30.55 | 31.00 | 31.02 | 36.65 | 36.72 | 33.76 | 34.01 | 35.99 | 36.00 |
| 37.56 | 37.59 | 49.03 | 48.99 | 57.00 | 56.89 | 60.00 | 59.98 | 64.02 | 63.87 | 86.12 | 86.08 | 74.90 | 75.03 | 77.30 | 77.35 |
| 34.01 | 33.98 | 42.88 | 42.99 | 49.02 | 48.99 | 52.32 | 53.32 | 64.00 | 63.99 | 85.93 | 85.98 | 61.77 | 61.99 | 69.00 | 68.99 |
| 38.00 | 37.99 | 44.01 | 44.05 | 48.98 | 48.89 | 55.65 | 55.74 | 60.03 | 59.99 | 98.01 | 97.99 | 67.63 | 67.71 | 83.00 | 82.99 |
| 22.00 | 21.99 | 21.98 | 21.99 | 23.88 | 23.99 | 24.00 | 23.99 | 26.77 | 26.97 | 37.87 | 37.87 | 28.97 | 29.03 | 34.62 | 34.63 |
| 23.00 | 23.02 | 25.00 | 24.99 | 26.55 | 26.97 | 31.00 | 30.99 | 33.02 | 32.87 | 37.27 | 37.26 | 32.84 | 32.96 | 33.72 | 33.76 |

**APPENDIX L**  
**Developed Models: External Validation Analysis**

**Table L1: External Validation Analysis, Actual Values vs Predicted Values for the Hearing Threshold**

| 250Hz          |                 | 500Hz          |                 | 1kHz           |                 | 2kHz           |                 | 3 kHz          |                 | 4kHz           |                 | 6kHz           |                 | 8kHz           |                 |
|----------------|-----------------|----------------|-----------------|----------------|-----------------|----------------|-----------------|----------------|-----------------|----------------|-----------------|----------------|-----------------|----------------|-----------------|
| Observed Value | Predicted Value | Observed Value | Predicted Value | Observed Value | Predicted Value | Observed Value | Predicted Value | Observed Value | Predicted Value | Observed Value | Predicted Value | Observed Value | Predicted Value | Observed Value | Predicted Value |
| 24.97          | 25.02           | 26.00          | 26.03           | 26.98          | 27.00           | 28.00          | 27.98           | 35.30          | 35.32           | 36.00          | 36.01           | 28.66          | 28.91           | 34.08          | 34.19           |
| 25.99          | 26.01           | 31.02          | 31.09           | 34.92          | 35.02           | 34.56          | 34.59           | 38.04          | 38.06           | 53.99          | 54.90           | 34.77          | 35.02           | 39.21          | 39.21           |
| 36.54          | 37.72           | 40.54          | 40.65           | 44.65          | 43.93           | 59.27          | 59.43           | 60.55          | 60.89           | 73.99          | 74.30           | 45.98          | 46.26           | 57.96          | 57.86           |
| 21.56          | 21.69           | 23.88          | 24.00           | 25.98          | 26.00           | 26.32          | 26.20           | 28.68          | 28.70           | 29.00          | 30.20           | 27.00          | 27.09           | 28.88          | 29.01           |
| 35.00          | 34.85           | 37.60          | 37.58           | 39.10          | 39.25           | 50.87          | 50.90           | 57.01          | 56.76           | 88.77          | 88.76           | 71.95          | 72.01           | 76.78          | 76.99           |
| 25.76          | 25.78           | 27.76          | 27.99           | 29.90          | 30.00           | 30.00          | 30.01           | 32.37          | 31.97           | 39.78          | 40.02           | 32.66          | 33.21           | 35.78          | 36.02           |
| 29.04          | 28.67           | 30.00          | 30.02           | 37.54          | 38.01           | 46.54          | 47.01           | 54.83          | 55.01           | 77.98          | 77.67           | 50.99          | 50.89           | 70.59          | 71.06           |
| 24.76          | 25.00           | 27.45          | 27.65           | 29.75          | 29.99           | 30.93          | 31.04           | 34.01          | 33.89           | 41.21          | 40.76           | 28.92          | 29.09           | 39.53          | 40.02           |
| 28.00          | 27.94           | 34.97          | 35.04           | 39.93          | 39.74           | 43.76          | 44.84           | 59.00          | 59.43           | 71.14          | 70.80           | 53.52          | 53.99           | 61.65          | 62.27           |
| 18.96          | 19.70           | 22.12          | 21.87           | 25.30          | 26.01           | 27.78          | 28.03           | 29.80          | 30.09           | 29.43          | 29.98           | 25.62          | 26.02           | 30.04          | 29.98           |
| 33.96          | 34.03           | 37.85          | 37.99           | 40.21          | 39.98           | 47.19          | 46.98           | 55.38          | 54.65           | 85.92          | 86.02           | 62.00          | 61.56           | 80.92          | 80.75           |
| 27.00          | 27.04           | 30.04          | 29.86           | 34.76          | 35.00           | 37.65          | 37.98           | 43.23          | 42.35           | 58.02          | 57.96           | 52.65          | 52.73           | 56.43          | 55.98           |
| 30.86          | 31.08           | 40.51          | 41.22           | 47.00          | 46.58           | 52.00          | 51.79           | 60.35          | 59.67           | 93.88          | 94.02           | 57.97          | 58.01           | 72.77          | 73.02           |
| 24.90          | 25.06           | 26.74          | 27.04           | 27.41          | 27.03           | 31.00          | 30.65           | 36.00          | 35.98           | 54.88          | 54.99           | 38.53          | 39.02           | 30.12          | 29.75           |
| 36.00          | 35.92           | 39.00          | 38.87           | 45.14          | 44.78           | 47.50          | 47.49           | 55.00          | 54.67           | 94.00          | 93.97           | 83.65          | 84.01           | 76.03          | 75.89           |
| 28.00          | 27.89           | 32.19          | 32.01           | 39.00          | 39.04           | 43.54          | 44.03           | 43.80          | 43.95           | 48.40          | 47.89           | 46.00          | 46.02           | 43.87          | 44.02           |
| 19.01          | 20.02           | 20.98          | 21.33           | 22.03          | 21.98           | 25.04          | 24.95           | 27.01          | 26.78           | 28.00          | 28.05           | 25.00          | 24.99           | 30.01          | 29.87           |
| 30.01          | 29.97           | 33.89          | 34.03           | 35.02          | 34.76           | 38.00          | 37.94           | 46.92          | 47.03           | 69.32          | 68.78           | 53.00          | 52.96           | 67.00          | 66.53           |
| 28.53          | 28.56           | 33.00          | 33.07           | 35.97          | 35.87           | 35.99          | 36.07           | 36.99          | 37.00           | 40.60          | 41.04           | 32.98          | 32.87           | 38.67          | 38.53           |
| 35.53          | 36.02           | 36.78          | 36.98           | 40.90          | 41.07           | 45.33          | 44.87           | 49.00          | 48.87           | 68.77          | 69.01           | 68.98          | 68.76           | 40.65          | 40.78           |

## APPENDIX M

### Details of Explanation of the Feasibility of the Optimal Age and Years of Exposure at the Responses of Frequency 250 Hz – 8 kHz.

$$\begin{aligned}HT_{250 \text{ Hz}} &= 44.14 + 0.6AG - 0.2NL - 0.01AG^2 \\ &= 44.14 + 0.6(57) - 0.2(93.2) - 0.01(57)^2 \\ &= 27.21 \text{ dB} < 30 \text{ dB (Feasible)}.\end{aligned}$$

If the worker starts work at age (57 -18) years; with 37 years of exposure to the noise in the quarry, by then, the age will be (57 - 18) + 37 years = 76 years > 52 years which is not feasible.

It is better for the worker in this category of age to have exposed to the noise exposure for the maximum of 13 years, when the age would have reached 52 years, after which he must be working at less noisy work zone.

$$\begin{aligned}HT_{500 \text{ Hz}} &= 337.4 - 2.6AG - 0.01AG*NL - 0.03AG^2 - 0.01NL^2 \\ &= 337.4 - 2.6(49) - 0.01(49)(96.7) - 0.03(49)^2 - 0.01(96.7)^2 \\ &= 90.59 \text{ dB} > 30 \text{ dB (Not Feasible)}.\end{aligned}$$

If the worker starts work at age (49 -18) years; with 33 years of exposure to the noise in the quarry, by then, the age will be (49 - 18) + 33 years = 64 years > 52 years which is not feasible.

It is better for the worker in this category of age to have maximum of 21 years of noise exposure, when the age would have reached 52 years, after which he must be working at less noisy work zone.

$$\begin{aligned}HT_{1 \text{ kHz}} &= 48.12 - 1.6AG + 0.6YE + 0.02AG^2 \\ &= 48.12 - 1.6(43) + 0.6(13) + 0.02(43)^2\end{aligned}$$

$$= 24.3 \text{ dB} < 30 \text{ dB (Feasible)}.$$

If the worker starts work at age (43 -18) years; with 13 years of exposure to the noise in the quarry, by then, the age will be (43 - 18) + 13 years = 38 years < 52 years which is feasible.

The worker in this category of age can still work in production section for up to 17 years of noise exposure, when the age would have reached 52 years, after which he must be working at less noisy work zone.

$$\begin{aligned} HT_{2 \text{ kHz}} &= 196.76 - 3.03AG + 1.5YE + 0.03AG^2 - 0.01NL^2 \\ &= 196.7 - 3.03(42) + 1.5(3) + 0.03(42)^2 - 0.01(94.8)^2 \\ &= 37.05 \text{ dB} > 30 \text{ dB (Not Feasible)}. \end{aligned}$$

If the worker starts work at age (42 -18) years; with 3 years of exposure to the noise in the quarry, by then, the age will be (42 - 18) + 3 years = 27 years < 52 years, which is feasible.

The worker in this category can still be fitted into the production section for the maximum time of 25 years of noise exposure, when the age would have reached 52 years, after which he must be working at less noisy work zone.

$$\begin{aligned} HT_{3 \text{ kHz}} &= 60.9 - 1.16AG + 0.02AG^2 - 0.04YE^2 \\ &= 60.9 - 1.16(52) + 0.02(52)^2 - 0.04(2)^2 \\ &= 50.304 \text{ dB} > 30 \text{ dB (Not Feasible)} \end{aligned}$$

If the worker starts work at age (52 -18) years; with 2 years of exposure to the noise in the quarry, by then, the age will be (52 - 18) + 2 years = 36 years < 52 years, which is feasible.

The workers in this category have the opportunity of maximum of 18 years of noise exposure, when the age would have reached 52 years, after which he must be working at less noisy work zone.

$$\begin{aligned}
HT_{4\text{ kHz}} &= 104.3 - 0.35AG - 0.08AG*YE \\
&= 104.3 - 0.35(60) - 0.08(60)(3) \\
&= 68.9 \text{ dB} > 30 \text{ dB (Not Feasible)}.
\end{aligned}$$

If the worker starts work at age (60 -18) years; with 3 years of exposure to the noise in the quarry, by then, the age will be (60 - 18) + 3 years = 45 years < 52 years, which is feasible.

There is maximum opportunity of 7 years for the worker in this category to work in the production section, when the age would have reached 52 years, after which he must be working at less noisy work zone.

$$\begin{aligned}
HT_{6\text{ kHz}} &= 35.08 - 0.16AG \\
&= 35.08 - 0.16 (55) \\
&= 26.28 \text{ dB} < 30 \text{ dB (Feasible)}.
\end{aligned}$$

If the worker starts work at age (55 -18) years; with 1 year of exposure to the noise in the quarry, by then, the age will be (55 - 18) + 1 year = 38 years < 52 years which is feasible.

The worker in this category still safe to work in noisy working area for the maximum period of 15 years, when the age would have reached 52 years, after which he must be working at less noisy work zone.

$$\begin{aligned}
HT_{8\text{ kHz}} &= 87.26 - 1.53AG \\
&= 87.26 - 1.53(38) \\
&= 29.12 \text{ dB} < 30 \text{ dB (Feasible)}.
\end{aligned}$$

If the worker starts work at age (38 -18) years; with 32 years of exposure to the noise in the quarry, by then, the age will be (38 - 18) + 32 years = 52 years which is feasible. The worker in this category can only work for 32 years or less in production section safely. After 32 years, the worker must be placed on less noise working zone.



The only feasible optimisation value of age is from 8 kHz frequency as 38 years or less and years of exposure as 32 years or less. Conclusively, this work predicts that the age of workers that works in the production or the noisy area in the quarry should not be more than 52 years with 32 years or less of noise exposure.

Thus, this expression :  $(X - 18) + Y \leq 52$  can be used to explain the relationship between the present age of the worker in the quarry and the optimal year of exposure to the noise, where X represent the present age of the workers and Y represent the optimal years of exposure to the noise.

## APPENDIX N

### Paired Sample Pearson Correlation, Coefficient of Mean Difference and Paired sample t- test

FILTER OFF.

USE 1 thru 185.

EXECUTE.

T-TEST PAIRS=NHTL@250 Hz NHTL@500 Hz NHTL@1 kHz NHTL@2KHz  
NHTL@3 kHz NHTL@4 kHz NHTL@6 kHz NHTL@8 kHz WITH HTL@250 Hz  
HTL@500 Hz HTL@1kHz HTL@2 kHz HTL@3 kHz HTL@4 kHz HTL@6 kHz  
HTL@8 kHz (PAIRED)

/CRITERIA=CI(.9500)

/MISSING=ANALYSIS.

## T-Test

### Notes

|                  |   |  |
|------------------|---|--|
| Output Created   | 29-OCT-2019 01:31:04  |  |
| Comments         |   |  |
| Input            | Data  | D:\orry<br>JOHNSON\Ori_Post_Sem1.sav   |
|                  | Active Dataset  | DataSet1   |
|                  | Filter  | <none>   |
|                  | Weight  | <none>   |
|                  | Split File  | <none>   |
|                  | N of Rows in Working Data File  | 185  |
| Missing Handling | Value Definition of Missing   | User defined missing values are treated as missing.  |
|                  | Cases Used  | Statistics for each analysis are based on the cases with no missing or out-of-range data for any variable in the analysis. |
| Syntax           | <pre>T-TEST PAIRS=NHTL@250Hz NHTL@500 Hz NHTL@1 kHz NHTL@2 kHz NHTL@3 kHz NHTL@4 kHz NHTL@6 kHz NHTL@8 kHz WITH HTL@250 Hz HTL@500 Hz HTL@1 kHz HTL@2 kHz HTL@3 kHz HTL@4 kHz HTL@6 kHz HTL@8 kHz (PAIRED)  /CRITERIA=CI(.9500)  /MISSING=ANALYSIS.</pre> |  |
| Resources        | Processor Time  | 00:00:00.08  |
|                  | Elapsed Time  | 00:00:00.16  |

[DataSet1] D:\orry JOHNSON\Ori\_Post\_Sem1.sav

### Paired Samples Statistics

|        |                                       | Mean  | N   | Std.<br>Deviation |  |
|--------|---------------------------------------|-------|-----|-------------------|--|
| Pair 1 | Hearing_Threshold_250<br>Hz after 1yr | 27.59 | 185 | 4.381             |  |
|        | Hearing_Threshold_250<br>Hz           | 24.23 | 185 | 7.870             |  |
| Pair 2 | Hearing_Threshold_500<br>Hz after 1yr | 31.79 | 185 | 5.662             |  |
|        | Hearing_Threshold_500<br>Hz           | 27.09 | 185 | 5.051             |  |
| Pair 3 | Hearing_Threshold_1 kHz<br>after 1yr  | 36.93 | 185 | 6.559             |  |
|        | Hearing_Threshold_1 kHz               | 30.32 | 185 | 6.587             |  |
| Pair 4 | Hearing_Threshold_2 kHz<br>after 1yr  | 42.71 | 185 | 7.564             |  |
|        | Hearing_Threshold_2 kHz               | 33.64 | 185 | 8.307             |  |
| Pair 5 | Hearing_Threshold_3 kHz<br>after 1yr  | 50.07 | 185 | 9.222             |  |
|        | Hearing_Threshold_3 kHz               | 37.66 | 185 | 9.973             |  |
| Pair 6 | Hearing_Threshold_4 kHz<br>after 1yr  | 65.02 | 185 | 13.979            |  |
|        | Hearing_Threshold_4 kHz               | 46.49 | 185 | 15.544            |  |
| Pair 7 | Hearing_Threshold_6 kHz<br>after 1yr  | 45.94 | 185 | 12.610            |  |
|        | Hearing_Threshold_6 kHz               | 36.59 | 185 | 12.157            |  |
| Pair 8 | Hearing_Threshold_8 kHz<br>after 1yr  | 48.72 | 185 | 12.139            |  |
|        | Hearing_Threshold_8 kHz               | 39.23 | 185 | 11.839            |  |

### Paired Samples Statistics

|        |                                    | Std. Error Mean |
|--------|------------------------------------|-----------------|
| Pair 1 | Hearing_Threshold_250 Hz after 1yr | 0.317           |
|        | Hearing_Threshold_250 Hz           | 0.569           |
| Pair 2 | Hearing_Threshold_500 Hz after 1yr | 0.410           |
|        | Hearing_Threshold_500 Hz           | 0.365           |
| Pair 3 | Hearing_Threshold_1 kHz after 1yr  | 0.475           |
|        | Hearing_Threshold_1 kHz            | 0.477           |
| Pair 4 | Hearing_Threshold_2 kHz after 1yr  | 0.547           |
|        | Hearing_Threshold_2 kHz            | 0.601           |
| Pair 5 | Hearing_Threshold_3 kHz after 1yr  | 0.667           |
|        | Hearing_Threshold_3 kHz            | 0.722           |
| Pair 6 | Hearing_Threshold_4 kHz after 1yr  | 1.012           |
|        | Hearing_Threshold_4 kHz            | 1.125           |
| Pair 7 | Hearing_Threshold_6 kHz after 1yr  | 0.912           |
|        | Hearing_Threshold_6 kHz            | 0.880           |
| Pair 8 | Hearing_Threshold_8 kHz after 1yr  | 0.878           |
|        | Hearing_Threshold_8 kHz            | 0.857           |

Paired Samples Correlations

|        |   | N   | Correlation | Sig.  |
|--------|---|-----|-------------|-------|
| Pair 1 | Hearing_Threshold_250 Hz<br>after 1yr &<br>Hearing_Threshold_250 Hz | 185 | 0.436       | 0.000 |
| Pair 2 | Hearing_Threshold_500 Hz<br>after 1yr &<br>Hearing_Threshold_500 Hz | 185 | 0.821       | 0.000 |
| Pair 3 | Hearing_Threshold_1 kHz after<br>1yr & Hearing_Threshold_1<br>kHz   | 185 | 0.770       | 0.000 |
| Pair 4 | Hearing_Threshold_2 kHz after<br>1yr & Hearing_Threshold_2<br>kHz   | 185 | 0.742       | 0.000 |
| Pair 5 | Hearing_Threshold_3<br>kHz after 1yr &<br>Hearing_Threshold_3 kHz   | 185 | 0.705       | 0.000 |
| Pair 6 | Hearing_Threshold_4 kHz after<br>1yr & Hearing_Threshold_4<br>kHz   | 185 | 0.795       | 0.000 |
| Pair 7 | Hearing_Threshold_6 kHz after<br>1yr & Hearing_Threshold_6<br>kHz   | 185 | 0.166       | 0.022 |
| Pair 8 | Hearing_Threshold_8 kHz after<br>1yr & Hearing_Threshold_8<br>kHz   | 185 | 0.664       | 0.000 |

**Paired Samples Test**

|        |   | Paired Differences |                |                 |  |  |  |  |  |
|--------|---|--------------------|----------------|-----------------|--|--|--|--|--|
|        |   | Mean               | Std. Deviation | Std. Error Mean |  |  |  |  |  |
| Pair 1 | Hearing_Thresh old_250 Hz after 1yr - Hearing_Thresh old_250 Hz | 3.361              | 7.147          | 0.517           |  |  |  |  |  |
| Pair 2 | Hearing_Thresh old_500 Hz after 1yr - Hearing_Thresh old_500 Hz | 4.696              | 3.256          | 0.236           |  |  |  |  |  |
| Pair 3 | Hearing_Thresh old_1 kHz after 1yr - Hearing_Thresh old_1 kHz   | 6.613              | 4.458          | 0.323           |  |  |  |  |  |
| Pair 4 | Hearing_Thresh old_2 kHz after 1yr - Hearing_Thresh old_2 kHz   | 9.063              | 5.738          | 0.415           |  |  |  |  |  |
| Pair 5 | Hearing_Thresh old_3 kHz after 1yr - Hearing_Thresh old_3 kHz   | 12.403             | 7.409          | 0.536           |  |  |  |  |  |
| Pair 6 | Hearing_Thresh old_4 kHz after 1yr - Hearing_Thresh old_4 kHz   | 18.524             | 9.575          | 0.693           |  |  |  |  |  |
| Pair 7 | Hearing_Thresh old_6 kHz after 1yr - Hearing_Thresh old_6 kHz   | 9.351              | 15.996         | 1.157           |  |  |  |  |  |

|        |   |       |       |       |  |  |  |  |  |
|--------|---|-------|-------|-------|--|--|--|--|--|
| Pair 8 | Hearing_Thresh<br>old_8 kHz after<br>1yr -<br>Hearing_Thresh<br>old_8 kHz | 9.492 | 9.832 | 0.711 |  |  |  |  |  |
|--------|---|-------|-------|-------|--|--|--|--|--|

**Paired Samples Test**

|        |   | Paired Differences                           |        |  |  |  |
|--------|---|--|--------|--|--|--|
|        |   | 95% Confidence Interval of<br>the Difference |        |  |  |  |
|        |   | Lower  | Upper  |  |  |  |
| Pair 1 | Hearing Threshold_<br>250 Hz after 1yr -<br>Hearing Threshold<br>250 Hz | 2.341  | 4.381  |  |  |  |
| Pair 2 | Hearing Threshold<br>500 Hz after 1yr -<br>Hearing Threshold<br>500 Hz  | 4.232  | 5.161  |  |  |  |
| Pair 3 | Hearing Threshold<br>1kHz after 1yr -<br>Hearing Threshold 1<br>kHz     | 5.976  | 7.249  |  |  |  |
| Pair 4 | Hearing Threshold 2<br>kHz after 1yr -<br>Hearing Threshold 2<br>kHz    | 8.244  | 9.882  |  |  |  |
| Pair 5 | Hearing Threshold 3<br>kHz after 1yr -<br>Hearing Threshold 3<br>kHz    | 11.346                                       | 13.461 |  |  |  |
| Pair 6 | Hearing Threshold 4<br>kHz after 1yr -<br>Hearing Threshold 4<br>kHz    | 17.157                                       | 19.890 |  |  |  |
| Pair 7 | Hearing Threshold 6<br>kHz after 1yr -<br>Hearing Threshold 6<br>kHz    | 7.068  | 11.634 |  |  |  |



|        |   |       |        |  |  |  |
|--------|---|-------|--------|--|--|--|
| Pair 8 | Hearing Threshold 8 kHz after 1yr – Hearing Threshold 8 kHz | 8.089 | 10.895 |  |  |  |
|--------|---|-------|--------|--|--|--|

**Paired Samples Test**

|        |   | t      | df  | Sig. (2-tailed) |
|--------|---|--------|-----|-----------------|
| Pair 1 | Hearing Threshold 250 Hz after 1yr – Hearing Threshold 250 Hz | 6.500  | 184 | 0.000           |
| Pair 2 | Hearing Threshold 500 Hz after 1yr – Hearing Threshold 500 Hz | 19.933 | 184 | 0.000           |
| Pair 3 | Hearing Threshold 1 kHz after 1yr – Hearing Threshold 1 kHz   | 20.502 | 184 | 0.000           |
| Pair 4 | Hearing Threshold 2 kHz after 1yr – Hearing Threshold 2 kHz   | 21.829 | 184 | 0.000           |
| Pair 5 | Hearing Threshold 3 kHz after 1yr – Hearing Threshold 3 kHz   | 23.136 | 184 | 0.000           |
| Pair 6 | Hearing Threshold 4 kHz after 1yr – Hearing Threshold 4 kHz   | 26.738 | 184 | 0.000           |
| Pair 7 | Hearing Threshold 6 kHz after 1yr – Hearing Threshold 6 kHz   | 8.079  | 184 | 0.000           |
| Pair 8 | Hearing Threshold 8 kHz after 1yr – Hearing Threshold 8 kHz   | 13.342 | 184 | 0.000           |